

Features

- ▶ Low noise figure
- ▶ High gain broadband performance
- ▶ Low current consumption
- ▶ All positive bias
- ▶ Pb-free RoHs compliant 4x4 QFN package

Description

The CMD228P4 is a broadband MMIC low noise amplifier housed in a leadless 4x4 mm plastic surface mount package. The CMD228P4 is ideally suited for microwave radios and S and C-band applications where high gain, low noise figure and low power consumption are needed. The broadband device delivers 28 dB of gain with a corresponding output 1 dB compression point of +13 dBm and a noise figure of 1.5 dB. The CMD228P4 is a 50 ohm matched design eliminating the need for external DC blocks and RF port matching.

Functional Block Diagram

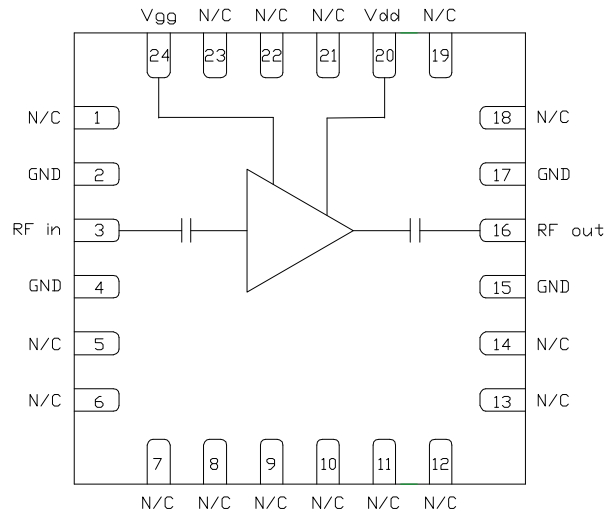

Electrical Performance - $V_{dd} = 4.0\text{ V}$, $V_{gg} = 4.0\text{ V}$, $T_A = 25\text{ }^\circ\text{C}$, $F = 4\text{ GHz}$

Parameter	Min	Typ	Max	Units
Frequency Range	2 - 6			GHz
Gain		28		dB
Noise Figure		1.5		dB
Input Return Loss		14		dB
Output Return Loss		12		dB
Output P1dB		13		dBm
Supply Current		45		mA



CMD228P4

2-6 GHz Low Noise Amplifier

Specifications

Absolute Maximum Ratings

Parameter	Rating
Drain Voltage, V _{dd}	5.5 V
Gate Voltage, V _{gg}	5.5 V
RF Input Power	+20 dBm
Channel Temperature, T _{ch}	150 °C
Power Dissipation, P _{diss}	464 mW
Thermal Resistance	140 °C/W
Operating Temperature	-40 to 85 °C
Storage Temperature	-55 to 150 °C

Operation of this device outside the maximum ratings may cause permanent damage.

Recommended Operating Conditions

Parameter	Min	Typ	Max	Units
V _{dd}	3.0	4.0	5.0	V
I _{dd}		45		mA
V _{gg}	3.0	4.0	5.0	V
I _{gg}		5		mA

Electrical performance is measured at specific test conditions. Electrical specifications are not guaranteed over all recommended operating conditions.

Electrical Specifications - V_{dd} = 4.0 V, V_{gg} = 4.0 V T_A = 25 °C

Parameter	Min	Typ	Max	Min	Typ	Max	Units
Frequency Range	2 - 4			4 - 6			GHz
Gain	25	28	31	24	27	31	dB
Noise Figure		1.5	1.9		1.7	2.1	dB
Input Return Loss		12			18		dB
Output Return Loss		13			13		dB
Output P1dB		12.5			13.5		dBm
Output IP3		24			25		dBm
Supply Current	30	45	60	30	45	60	mA
Gain Temperature Coefficient		0.014			0.014		dB/°C
Noise Figure Temperature Coefficient		0.007			0.007		dB/°C

ver 1.1 0516

Typical Performance

Broadband Performance, $V_{dd} = 4.0\text{ V}$, $V_{gg} = 4.0\text{ V}$, $I_{dd} = 45\text{ mA}$, $T_A = 25\text{ }^\circ\text{C}$

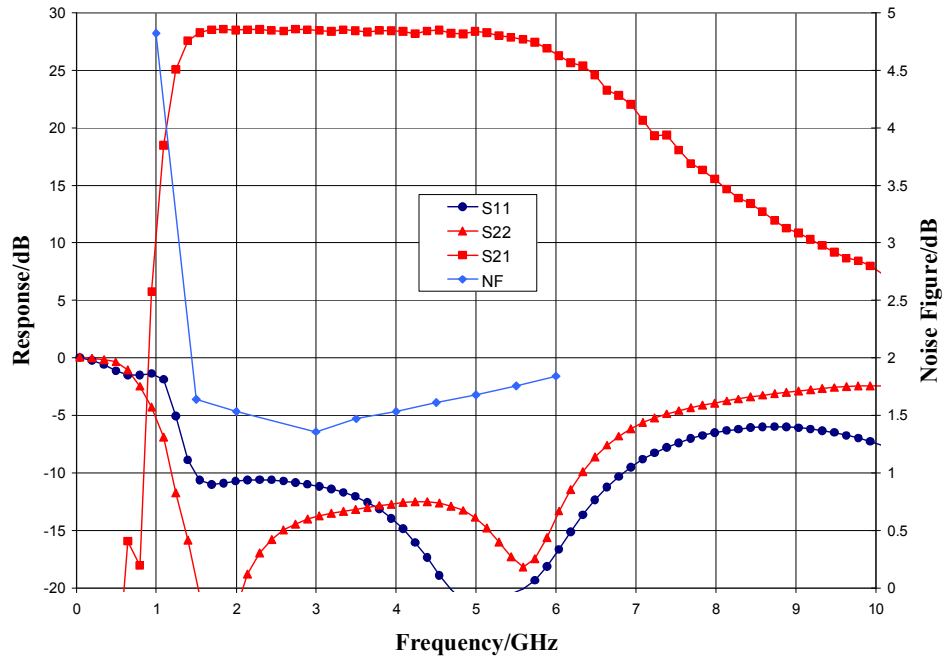

Narrow-band Performance, $V_{dd} = 4.0\text{ V}$, $V_{gg} = 4.0\text{ V}$, $I_{dd} = 45\text{ mA}$, $T_A = 25\text{ }^\circ\text{C}$

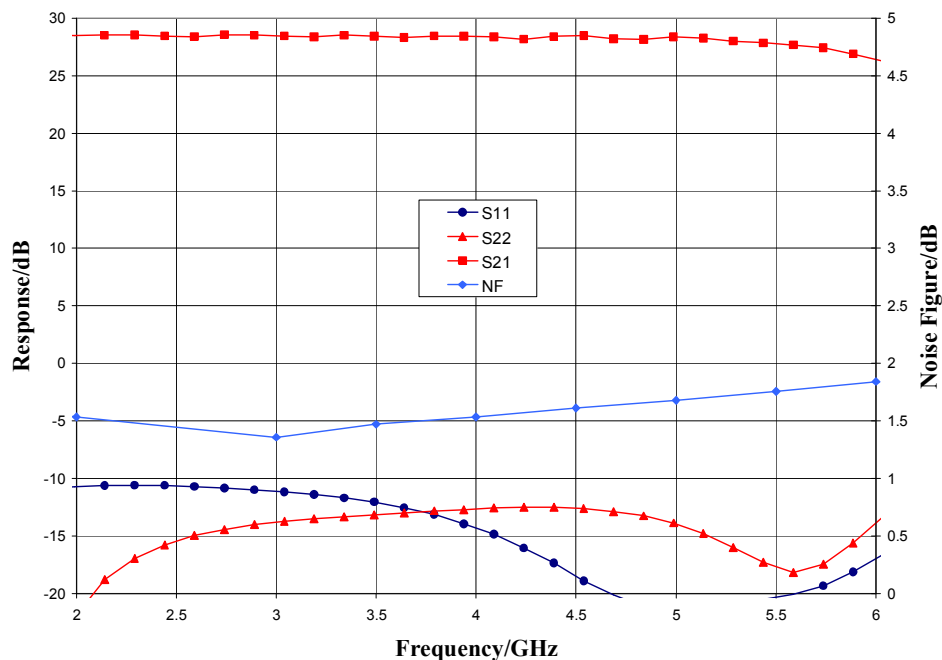

ver 1.1 0516

Typical Performance

Gain vs. Temperature, $V_{dd} = 4.0\text{ V}$, $V_{gg} = 4.0\text{ V}$

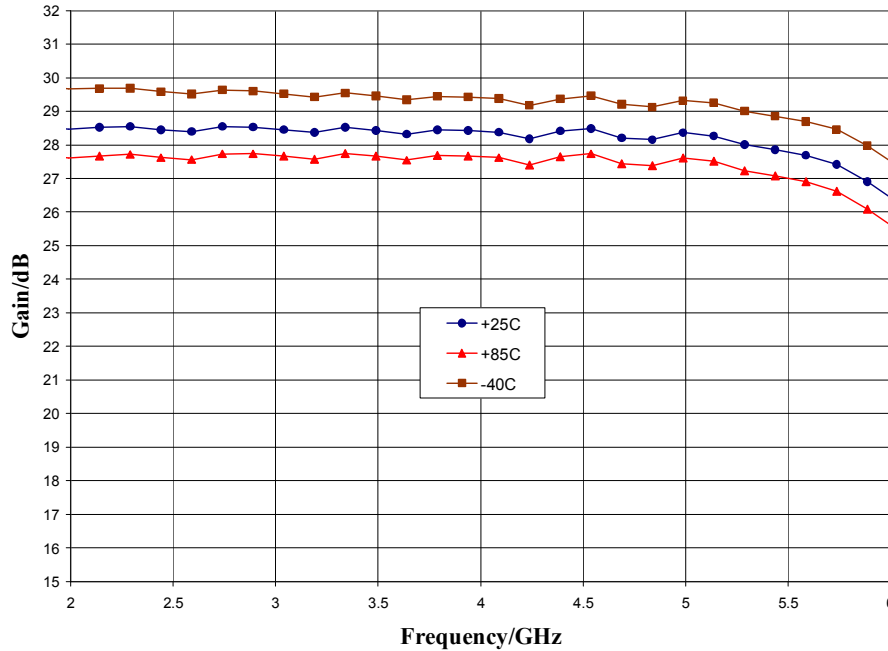

Noise Figure vs. Temperature, $V_{dd} = 4.0\text{ V}$, $V_{gg} = 4.0\text{ V}$

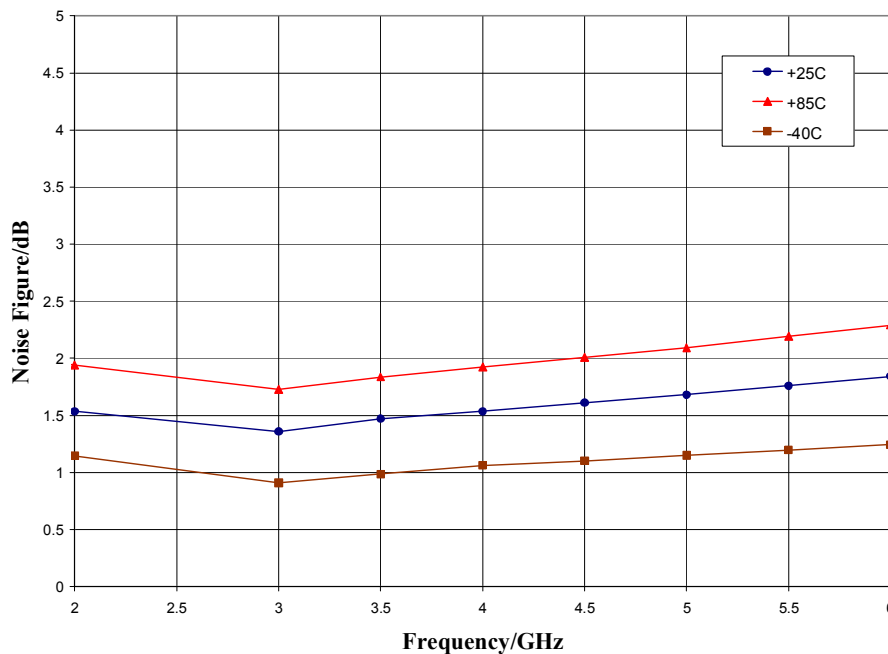

ver 1.1 0516

Typical Performance

Output Power, $V_{dd} = 4.0\text{ V}$, $V_{gg} = 4.0\text{ V}$, $T_A = 25\text{ }^\circ\text{C}$

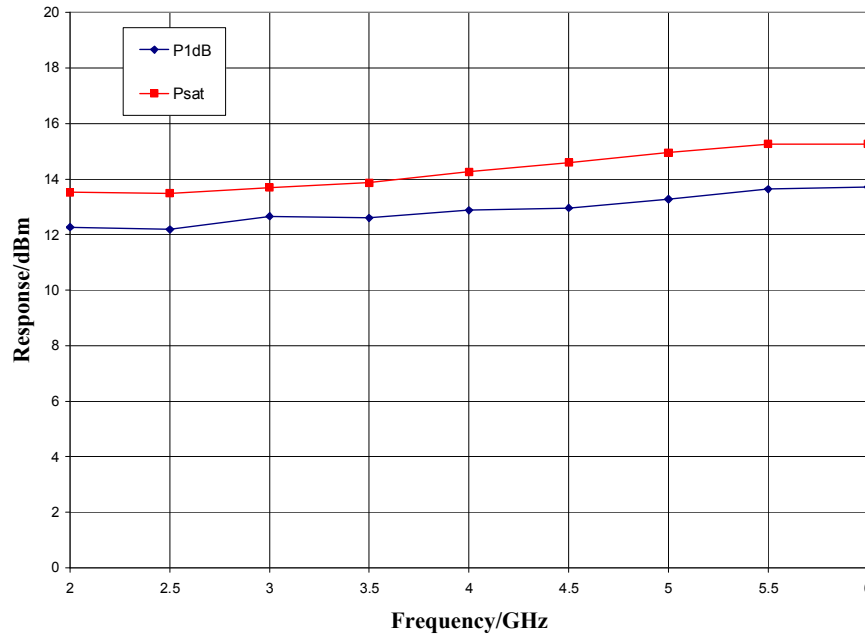

P1dB vs. Temperature, $V_{dd} = 4.0\text{ V}$, $V_{gg} = 4.0\text{ V}$

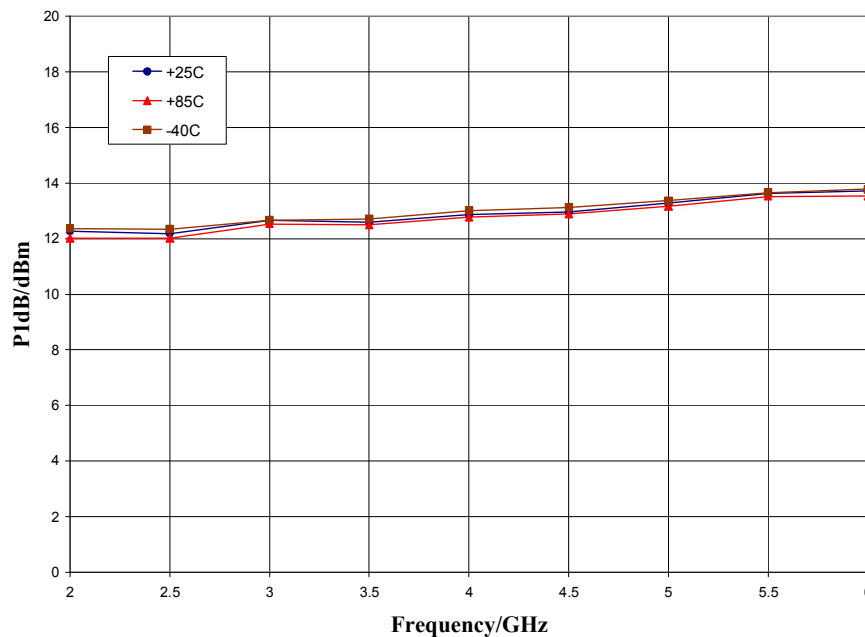

ver 1.1 0516

Typical Performance

Output IP3 vs. Temperature, $V_{dd} = 4.0\text{ V}$, $V_{gg} = 4.0\text{ V}$

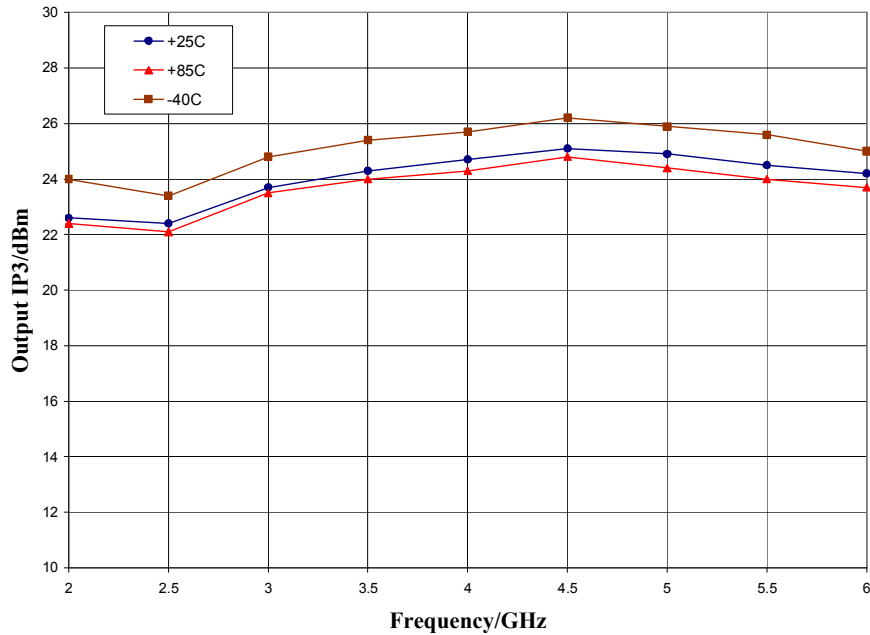

Mechanical Information

Package Information and Dimensions

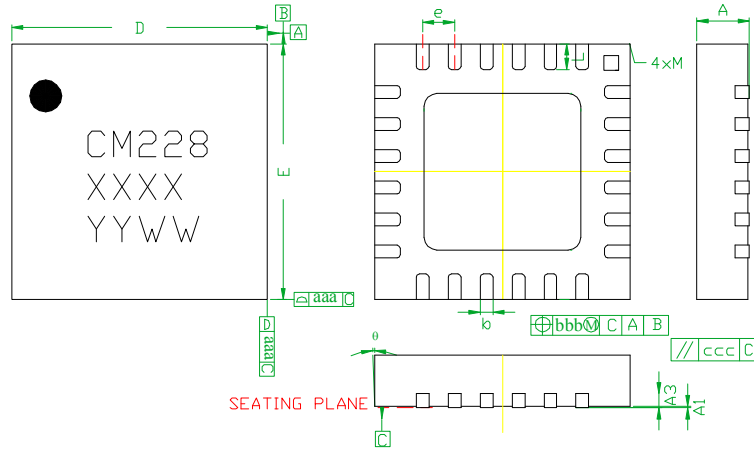

SYMBOLS	DIMENSIONS IN MILLIMETERS		
	MIN	NOM	MAX
A	0.80	0.90	1.00
A1	0	0.02	0.05
A3	---	0.25REF.	---
b	0.18	0.23	0.30
D	3.85	4.00	4.15
D1	---	2.45BSC	---
E	3.85	4.00	4.15
E1	---	2.45BSC	---
e	---	0.50BSC	---
L	0.30	0.40	0.50
ø	0	---	12
aaa	---	0.25	---
bbb	---	0.10	---
ccc	---	0.10	---
M	---	---	0.05

NOTES:

1. DIMENSIONS ARE IN MILLIMETERS
2. RoHS COMPLIANT MOLD COMPOUND
3. LEADFRAME MATERIAL: COPPER ALLOY
4. LEAD FINISH: 100% MATTE Sn
5. INDICATED DIMENSION/TOLERANCE APPLIES TO LEADS AND EXPOSED PAD

Recommended PCB Land Pattern

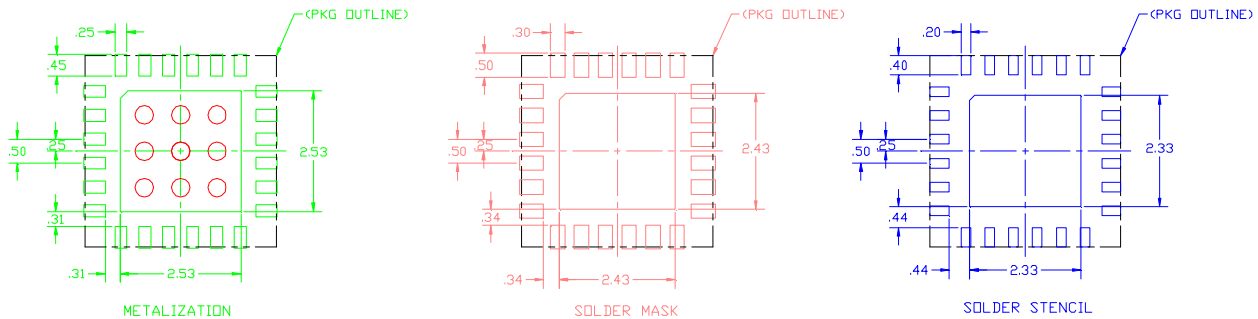

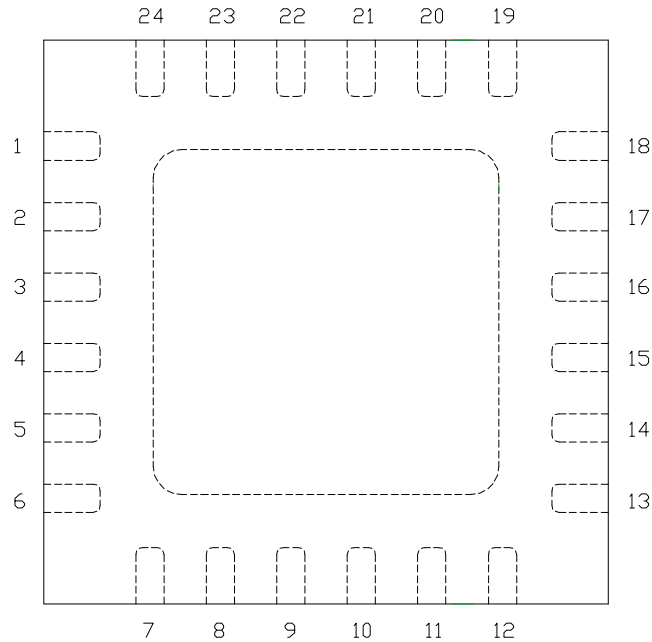

Pin Description

Pin Diagram

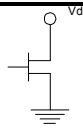
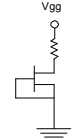

Functional Description

Pad	Function	Description	Schematic
1, 5-14, 18, 19, 21-23	N/C	No connection required. These pins may be connected to RF/DC ground	
2, 4, 15, 17 and die paddle	Ground	Connect to RF/DC ground	
3	RF in	DC blocked and 50 ohm matched	
16	RF out	DC blocked and 50 ohm matched	
20	Vdd	Power supply voltage Decoupling and bypass caps required	
24	Vgg	Power supply voltage Decoupling and bypass caps required	

ver 1.1 0516

Applications Information

Application Circuit

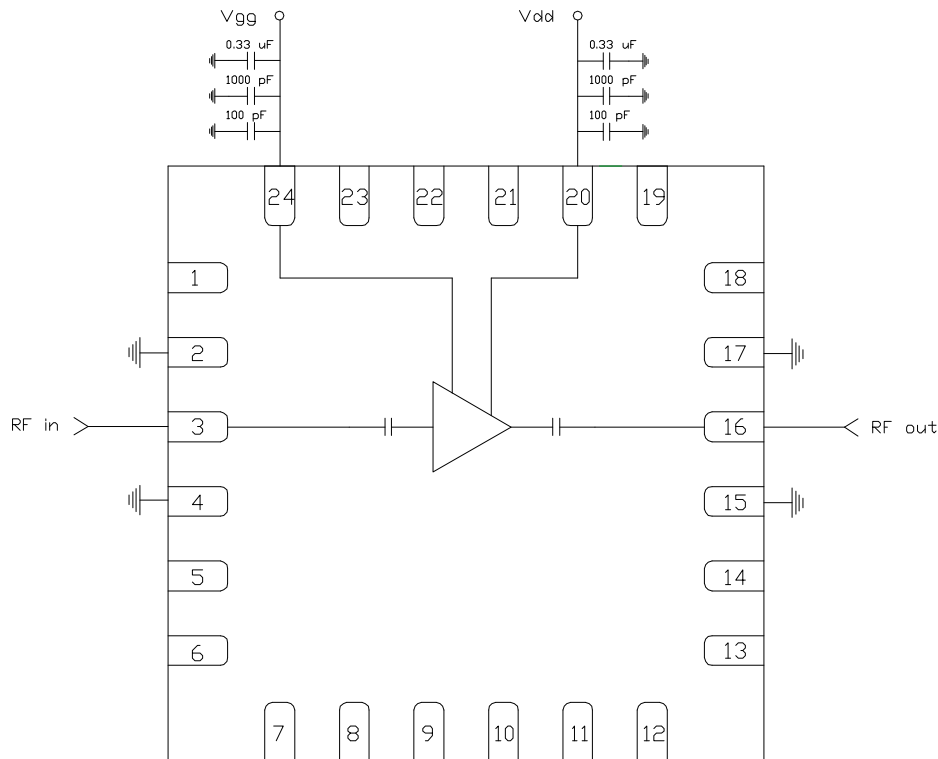

Biasing and Operation

The CMD228P4 is biased with a positive drain supply and positive gate supply.

Turn ON procedure:

1. Apply drain voltage V_{dd} and set to +4 V
2. Apply gate voltage V_{gg} and set to +4 V

Turn OFF procedure:

1. Turn off gate voltage V_{gg}
2. Turn off drain voltage V_{dd}

RF power can be applied at any time.

GaAs MMIC devices are susceptible to damage from Electrostatic Discharge. Proper precautions should be observed during handling, assembly and test.

ver 1.1 0516

Applications Information

Evaluation Board

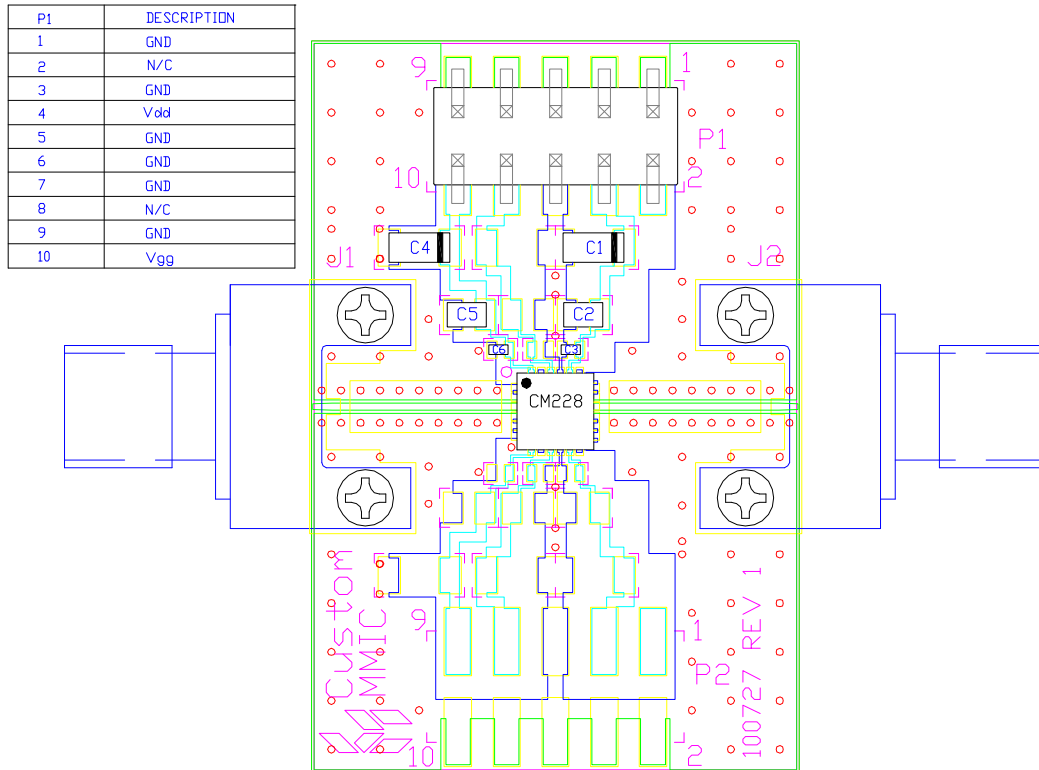

Bill of Material

Designator	Value	Description
J1, J2		SMA End Launch Connector
P1		10 Pin DC Header
C1, C4	0.33 μ F	Capacitor, Tantalum
C2, C5	1000 pF	Capacitor, 0603
C3, C6	100 pF	Capacitor, 0402
U1		CMD228P4 Driver Amplifier
PCB		100727 Evaluation PCB