



CMD173P4

DC-20 GHz Distributed Amplifier

Features

- ▶ Ultra wideband performance
- ▶ Low noise figure
- ▶ Low current consumption
- ▶ Pb-free RoHs compliant 4x4 QFN package

Description

The CMD173P4 is wideband GaAs MMIC distributed amplifier housed in a leadless 4x4 mm plastic surface mount package. The amplifier operates from DC to 20 GHz and delivers greater than 15 dB of gain with a corresponding output 1 dB compression point of +18 dBm and noise figure of 2 dB at 10 GHz. The CMD173P4 is a 50 ohm matched design which eliminates the need for RF port matching.

Functional Block Diagram

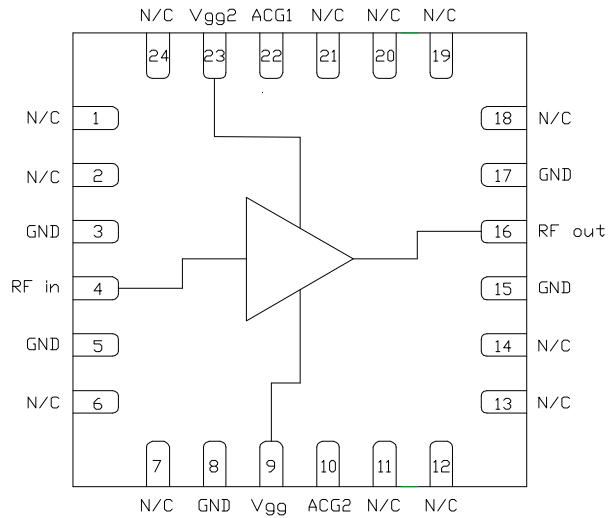

Note: V_{gg2} is optional for gain control

Electrical Performance - V_{dd} = 8.0 V, V_{gg} = 3.0 V, T_A = 25 °C, F = 10 GHz

Parameter	Min	Typ	Max	Units
Frequency Range	DC - 20			GHz
Gain		15		dB
Noise Figure		2		dB
Input Return Loss		14		dB
Output Return Loss		13		dB
Output P1dB		18		dBm
Output IP3		28		dBm
Output IP2		27		dBm
Supply Current		78		mA

ver 4.0 1218



CMD173P4

DC-20 GHz Distributed Amplifier

Specifications

Absolute Maximum Ratings

Parameter	Rating
Drain Voltage, V _{dd}	10 V
Gate Voltage, V _{gg}	4 V
RF Input Power	+20 dBm
Channel Temperature, T _{ch}	150 °C
Power Dissipation, P _{diss}	904 mW
Thermal Resistance Θ_{JC}	72 °C/W
Operating Temperature	-40 to 85 °C
Storage Temperature	-55 to 150 °C

Exceeding any one or combination of the maximum ratings may cause permanent damage to the device.

Recommended Operating Conditions

Parameter	Min	Typ	Max	Units
V _{dd}	5.0	8.0	10.0	V
I _{dd}		78		mA
V _{gg}	0	3.0	4.0	V

Electrical performance is measured at specific test conditions. Electrical specifications are not guaranteed over all recommended operating conditions.

Electrical Specifications, V_{dd} = 8.0 V, V_{gg} = 3.0 V, T_A = 25 °C

Parameter	Min	Typ	Max	Min	Typ	Max	Units
Frequency Range	DC - 10			10 - 20			GHz
Gain	13	15		13	15.5		dB
Noise Figure		1.7			2.6		dB
Input Return Loss		13			10		dB
Output Return Loss		15			17		dB
Output P1dB	16	18		14	17		dBm
Output IP3		28			25		dBm
Output IP2		30			35		dBm
Supply Current	55	78	115	55	78	115	mA
Gain Temperature Coefficient		0.01			0.01		dB/°C
Noise Figure Temperature Coefficient		0.01			0.01		dB/°C

ver 4.0 1218

Typical Performance

Broadband Performance, $V_{dd} = 8.0$ V, $V_{gg} = 3.0$ V, $I_{dd} = 78$ mA, $T_A = 25$ °C

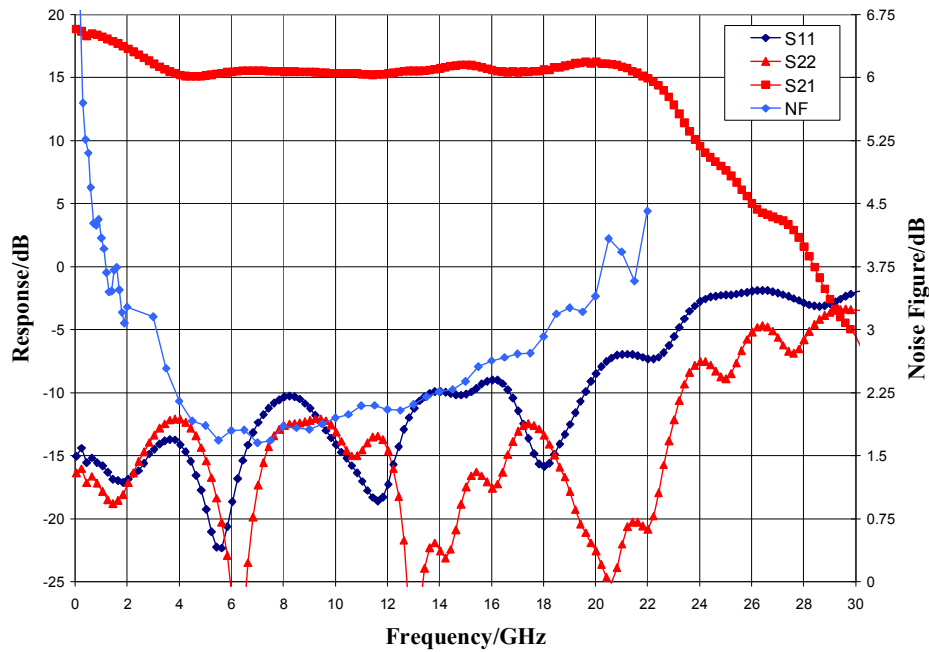

Narrow-band Performance, $V_{dd} = 8.0$ V, $V_{gg} = 3.0$ V, $I_{dd} = 78$ mA, $T_A = 25$ °C

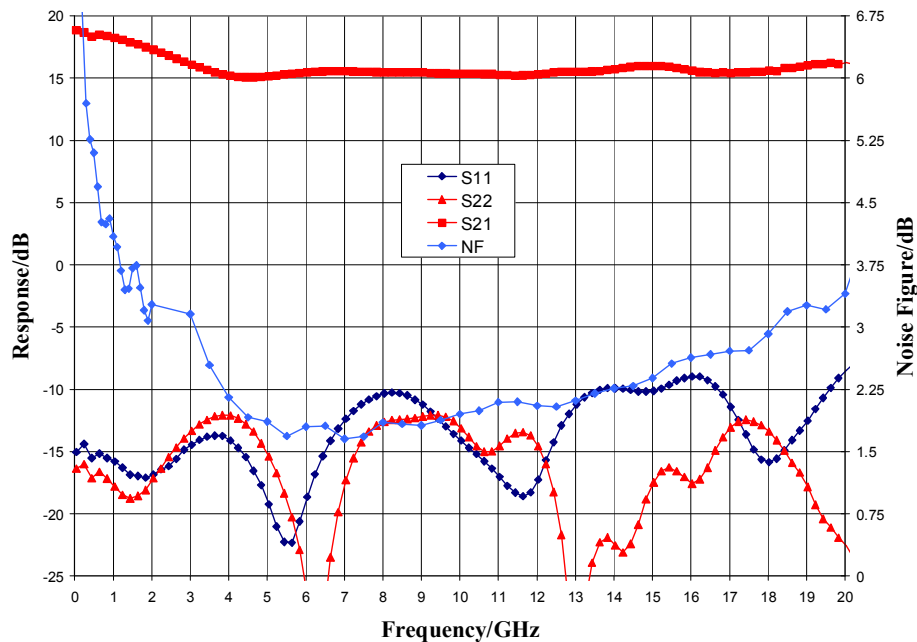

ver 4.0 1218

Typical Performance

Gain vs. Temperature, $V_{dd} = 8.0\text{ V}$, $V_{gg} = 3.0\text{ V}$

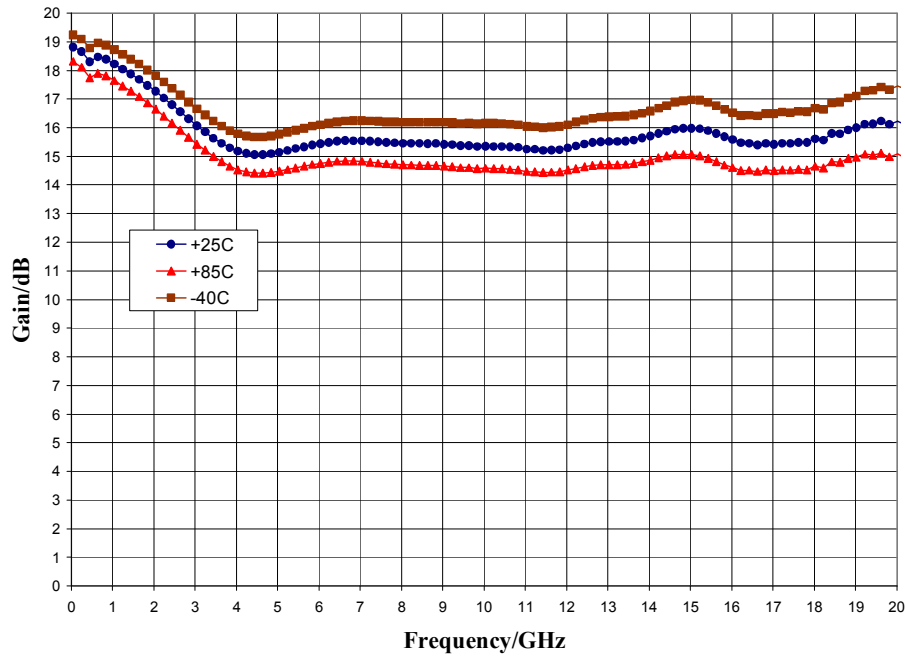

Noise Figure vs. Temperature, $V_{dd} = 8.0\text{ V}$, $V_{gg} = 3.0\text{ V}$

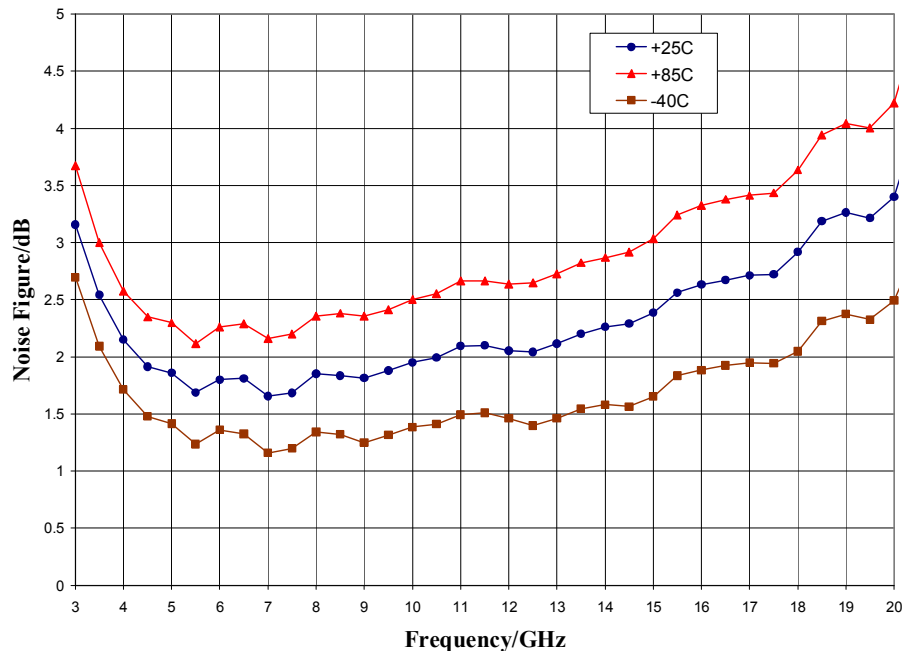

ver 4.0 1218

Typical Performance

Output Power, $V_{dd} = 8.0\text{ V}$, $V_{gg} = 3.0\text{ V}$, $T_A = 25\text{ }^\circ\text{C}$

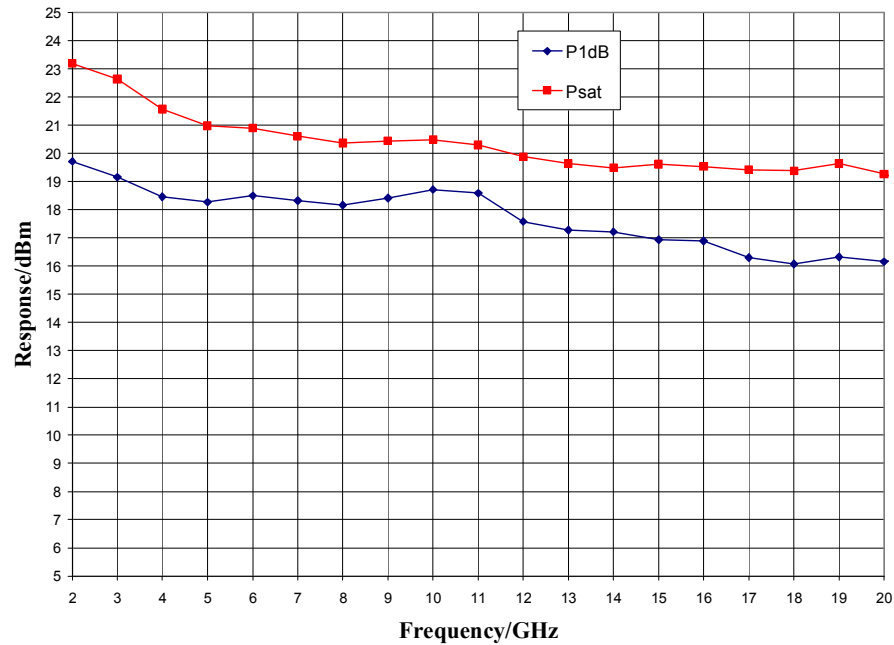

P1dB vs. Temperature, $V_{dd} = 8.0\text{ V}$, $V_{gg} = 3.0\text{ V}$

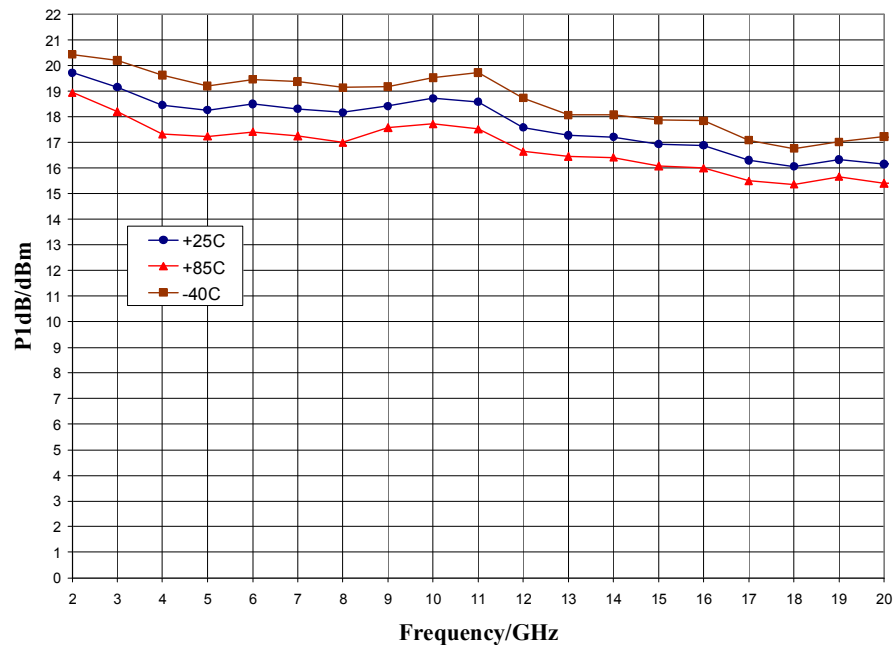

ver 4.0 1218

Typical Performance

Output IP3 vs. Temperature, $V_{dd} = 8.0\text{ V}$, $V_{gg} = 3.0\text{ V}$

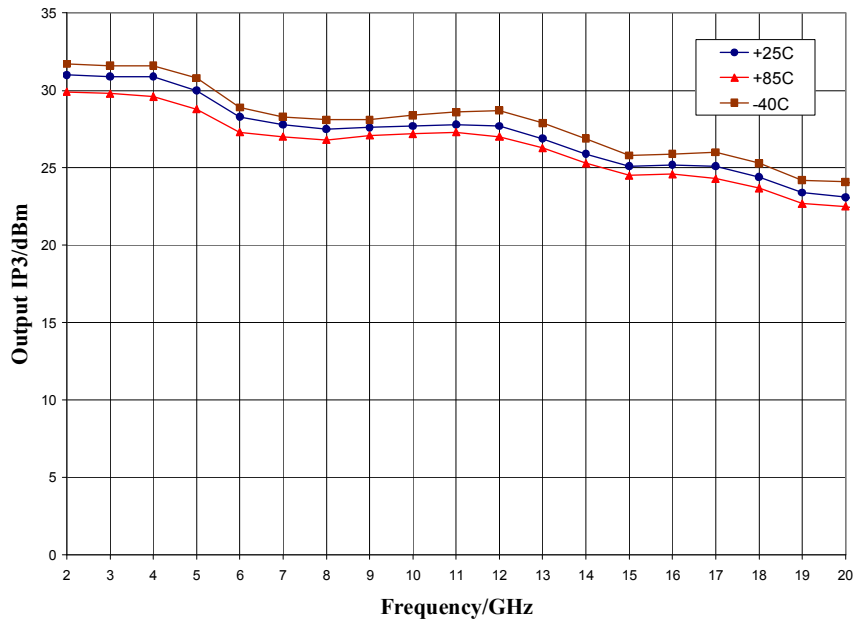

Output IP2, $V_{dd} = 8.0\text{ V}$, $V_{gg} = 3.0\text{ V}$, $T_A = 25\text{ }^\circ\text{C}$

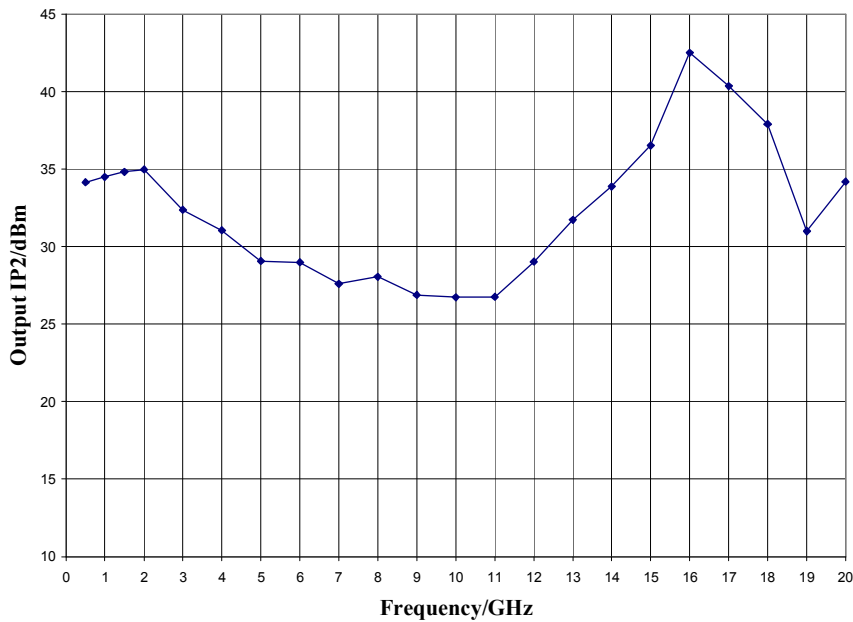

Mechanical Information

Package Information and Dimensions

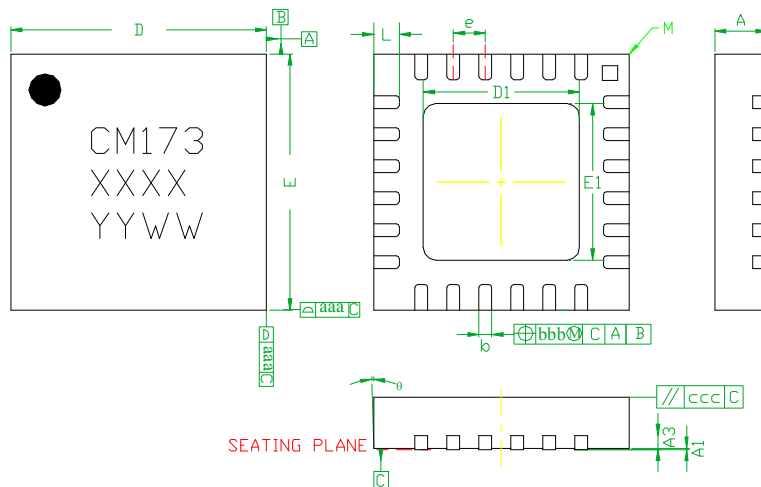

SYMBOLS	DIMENSIONS IN MILLIMETERS		
	MIN	NOM	MAX
A	0.80	0.90	1.00
A1	0	0.02	0.05
A3	---	0.25REF.	---
b	0.18	0.23	0.30
D	3.85	4.00	4.15
D1	2.40	2.50	2.60
E	3.85	4.00	4.15
E1	2.40	2.50	2.60
e	---	0.50BSC	---
L	0.30	0.40	0.50
e	0	---	12
aaa	---	0.25	---
bbb	---	0.10	---
ccc	---	0.10	---
M	---	---	0.05

NOTES:

1. DIMENSIONS ARE IN MILLIMETERS
2. RoHS COMPLIANT MOLD COMPOUND
3. LEADFRAME MATERIAL: COPPER ALLOY
4. LEAD FINISH: 100% MATTE Sn
5. INDICATED DIMENSION/TOLERANCE APPLIES TO LEADS AND EXPOSED PAD

Recommended PCB Land Pattern

Custom MMIC Design Services recommends that the user develop the land pattern that will provide the best design for proper solder reflow and device attach for their specific application. Please review CMDS Application Note AN 105 for a recommended land pattern approach.

Recommended Solder Reflow Profile



Custom MMIC Design Services recommends screen printing with belt furnace reflow to ensure proper solder reflow and device attach. Please review CMDS Application Note AN 102 for a recommended solder reflow profile.

Pin Description

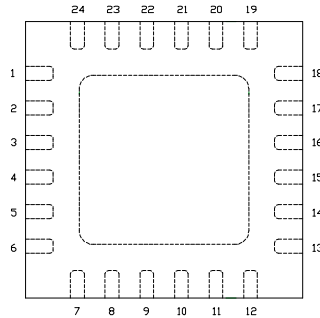
Pin Diagram

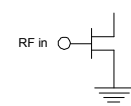
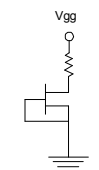
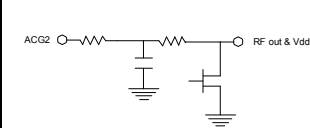
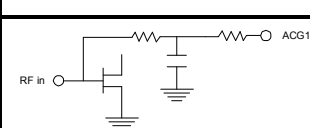
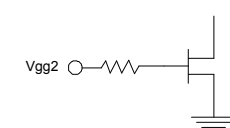

Functional Description

Pad	Function	Description	Schematic
1,2,6,7,11-14,18-21,24	N/C	No connection required. These pins may be connected to RF/DC ground	
4	RF in	50 ohm matched input	
9	Vgg	Power supply voltage Decoupling and bypass caps required	
10	ACG2	Low frequency termination. Attach bypass capacitor per application circuit	
16	RF out & Vdd	Power supply voltage and 50 ohm matched output	
22	ACG1	Low frequency termination. Attach bypass capacitor per application circuit	
23	Vgg2	Optional supply voltage for gain control Decoupling and bypass caps required	
3,5,8,15,17 and die paddle	Ground	Connect to RF / DC ground	

ver 4.0 1218

Applications Information

Application Circuit

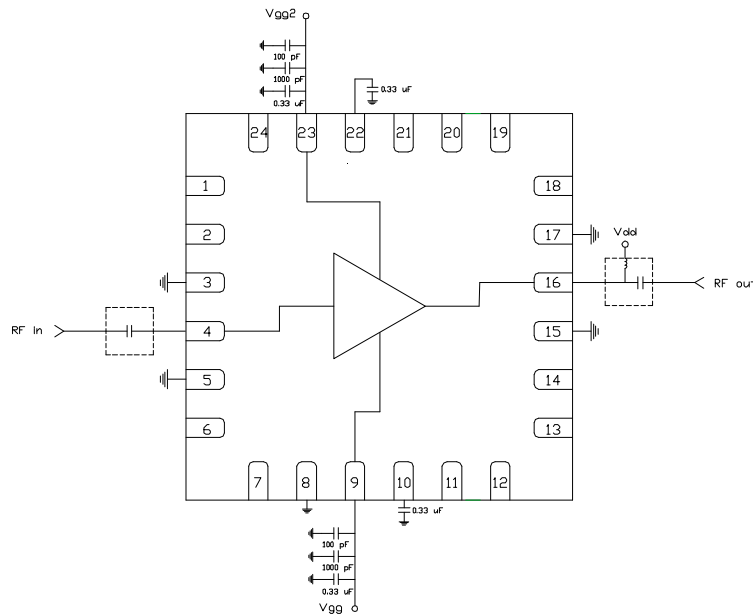

Note: Drain voltage (V_{dd}) must be applied through a broadband bias tee or external bias network. External DC block is required on RF input.

Biasing and Operation

The CMD173P4 is biased with a positive drain supply and positive gate supply. Performance is optimized when the drain voltage is set to +8.0 V. The recommended gate voltage is +3.0 V.

Turn ON procedure:

1. Apply drain voltage V_{dd} and set to +8 V
2. Apply gate voltage V_{gg} and set to +3 V

Turn OFF procedure:

1. Turn off gate voltage V_{gg}
2. Turn off drain voltage V_{dd}

RF power can be applied at any time.

GaAs MMIC devices are susceptible to damage from Electrostatic Discharge. Proper precautions should be observed during handling, assembly and test.

Applications Information

Evaluation Board

The circuit board shown has been developed for optimized assembly at CMDS. A sufficient number of via holes should be used to connect the top and bottom ground planes. As surface mount processes vary, careful process development is recommended.

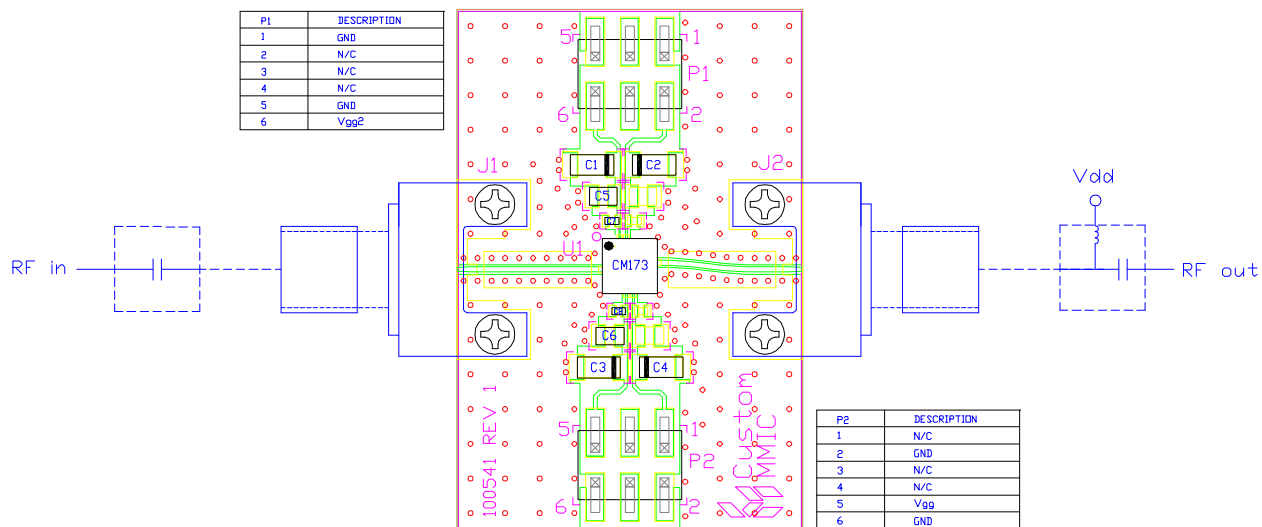

Bill of Material

Designator	Value	Description
J1, J2		SMA End Launch Connector
P1, P2		6 Pin DC Header
C1 - C4	0.33 μ F	Capacitor, Tantalum
C5, C6	1000 pF	Capacitor, 0603
C7, C8	100 pF	Capacitor, 0402
U1		CMD173P4 Driver Amplifier
PCB		100541 Evaluation PCB