

### Features

- ▶ Wide bandwidth
- ▶ High gain
- ▶ High linearity
- ▶ Integrated RF power detector
- ▶ AMMC-6345 replacement
- ▶ Small die size

### Description

The CMD293 is a wideband medium power GaAs MMIC driver amplifier ideally suited for military, space and communications systems where small size and high linearity are needed. At 30 GHz the device delivers 20 dB of gain with a corresponding output 1 dB compression point of +26 dBm and noise figure of 6 dB. The CMD293 integrates a temperature compensated RF power detection circuit that enables power detection at 0.7 V/W at 30 GHz. The device is a 50 ohm matched design which eliminates the need for external DC blocks and RF port matching. The CMD293 offers full passivation for increased reliability and moisture protection.

### Functional Block Diagram

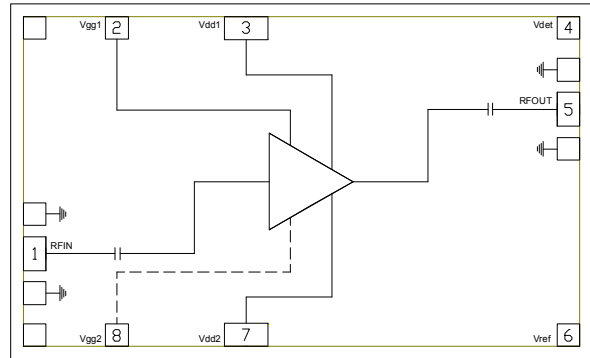

### Electrical Performance - $V_{dd} = 5.0 \text{ V}$ , $I_{dd} = 480 \text{ mA}$ , $T_A = 25 \text{ }^\circ\text{C}$ , $F = 30 \text{ GHz}$

Parameter	Min	Typ	Max	Units
Frequency Range	20 - 45			GHz
Gain		20		dB
Noise Figure		6		dB
Input Return Loss		20		dB
Output Return Loss		25		dB
Output P1dB		26		dBm
Output IP3		31.5		dBm
Supply Current		480		mA

ver 1.1 1018

### Specifications

#### Absolute Maximum Ratings

Parameter	Rating
Drain Voltage, V <sub>dd</sub>	5.5 V
RF Input Power	+23 dBm
Channel Temperature, T <sub>ch</sub>	150 °C
Power Dissipation, P <sub>diss</sub>	3.346 W
Thermal Resistance, $\Theta_{JC}$	19.43 °C/W
Operating Temperature	-55 to 85 °C
Storage Temperature	-55 to 150 °C

Exceeding any one or combination of the maximum ratings may cause permanent damage to the device.

#### Recommended Operating Conditions

Parameter	Min	Typ	Max	Units
V <sub>dd</sub>	3.0	5.0	5.25	V
I <sub>dd</sub>		480		mA
V <sub>gg</sub>		-0.45		V

Electrical performance is measured at specific test conditions. Electrical specifications are not guaranteed over all recommended operating conditions.

#### Electrical Specifications, V<sub>dd</sub> = 5.0 V, I<sub>dd</sub> = 480 mA, T<sub>A</sub> = 25 °C

Parameter	Min	Typ	Max	Min	Typ	Max	Min	Typ	Max	Units
Frequency Range	20 - 24			24 - 34			34 - 45			GHz
Gain	17.5	20.5		16	20		14.5	21		dB
Noise Figure		6			5.75			6		dB
Input Return Loss		13			18			17		dB
Output Return Loss		25			20			15		dB
Output P <sub>1dB</sub>	21	25		22.5	26		20.5	24		dBm
Output IP <sub>3</sub>		32			31.5			30.5		dBm
Supply Current		480	560		480	560		480	560	mA
Gain Temperature Coefficient		0.04			0.04			0.04		dB/°C
Noise Figure Temp. Coefficient		0.015			0.015			0.015		dB/°C

ver 1.1 1018

### Typical Performance

**Broadband Performance,  $V_{dd} = 5.0\text{ V}$ ,  $I_{dd} = 480\text{ mA}$ ,  $T_A = 25\text{ }^\circ\text{C}$**

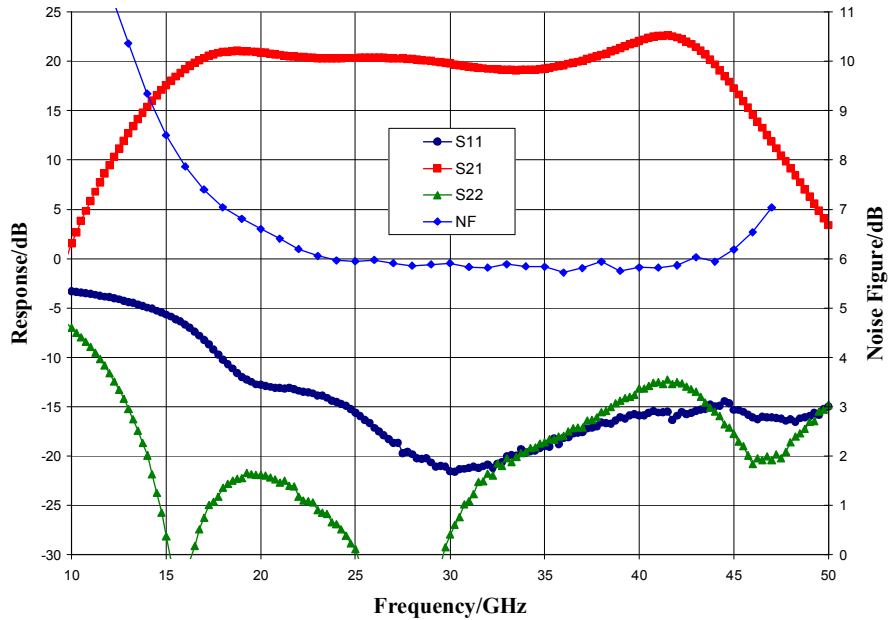

**Narrow-band Performance,  $V_{dd} = 5.0\text{ V}$ ,  $I_{dd} = 480\text{ mA}$ ,  $T_A = 25\text{ }^\circ\text{C}$**

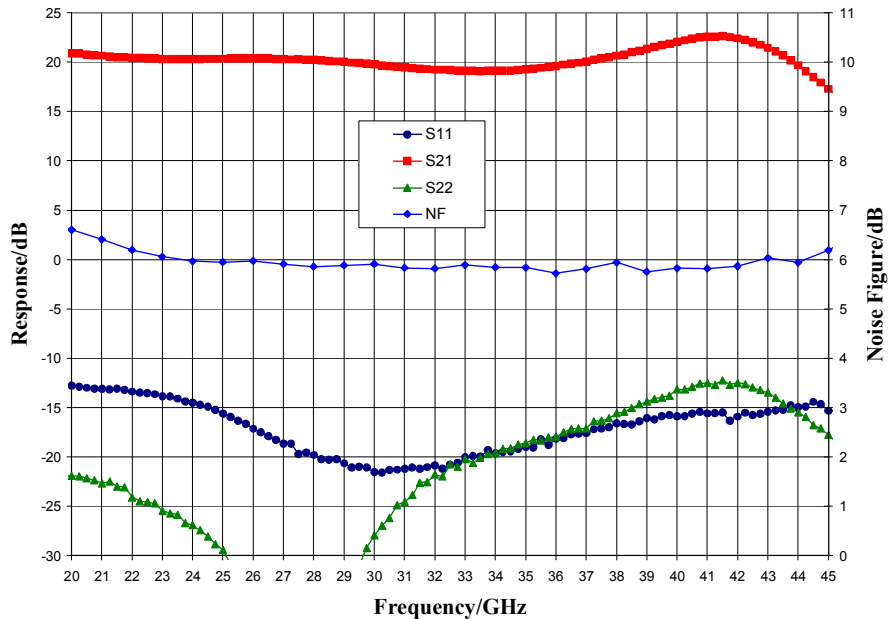

ver 1.1 1018

### Typical Performance

Gain vs. Temperature,  $V_{dd} = 5.0\text{ V}$

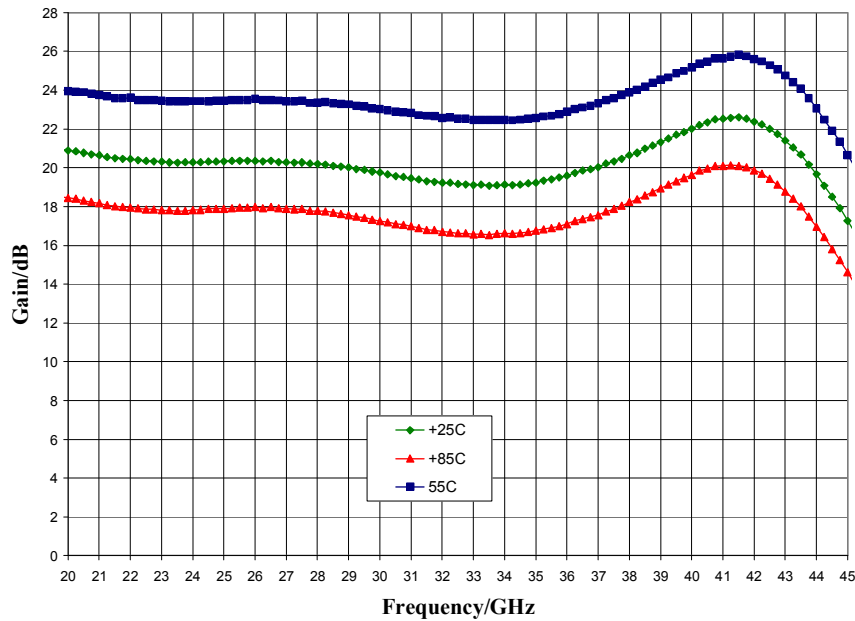

Gain vs  $V_{dd}$ ,  $I_{dd} = 480\text{ mA}$ ,  $T_A = 25\text{ }^\circ\text{C}$

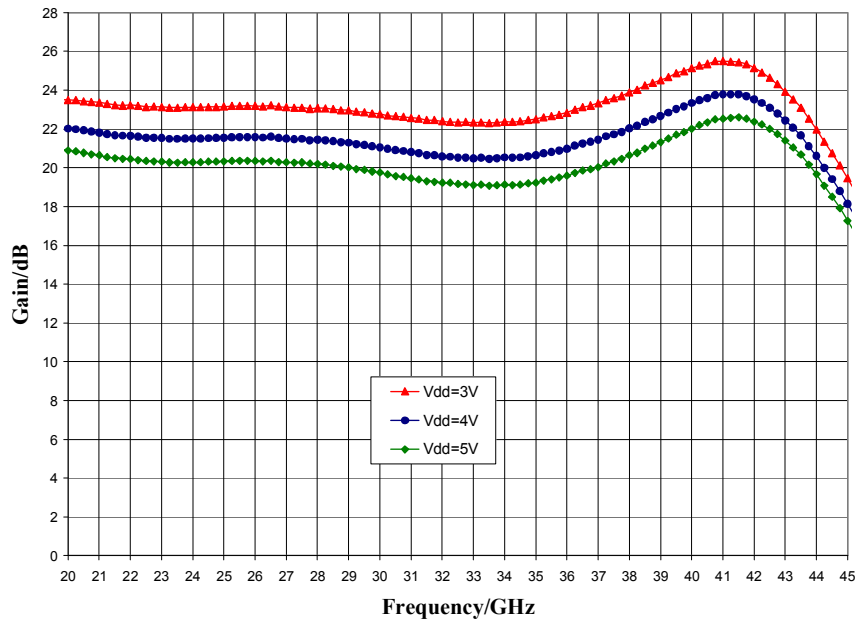

### Typical Performance

Noise Figure vs. Temperature,  $V_{dd} = 5.0 \text{ V}$

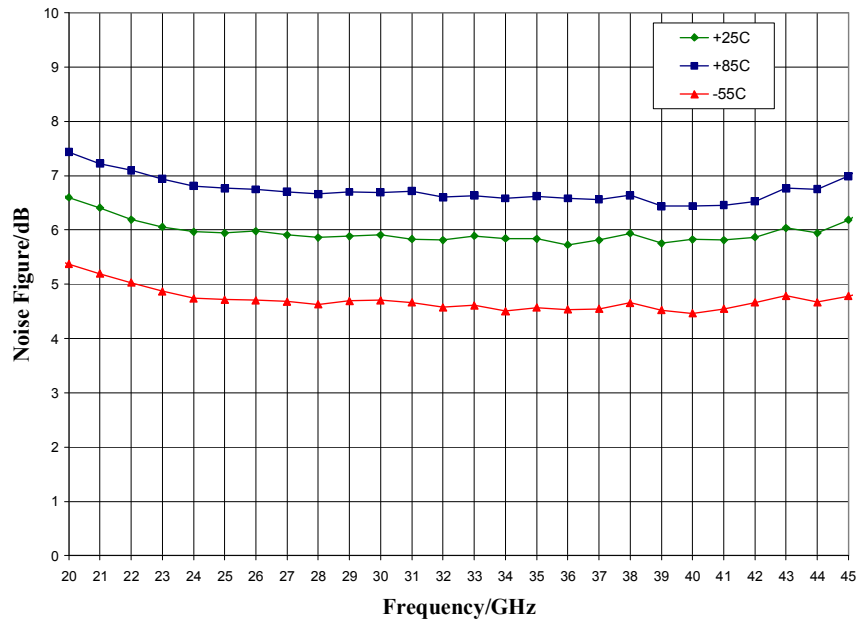

Noise Figure vs  $V_{dd}$ ,  $I_{dd} = 480 \text{ mA}$ ,  $T_A = 25 \text{ }^\circ\text{C}$

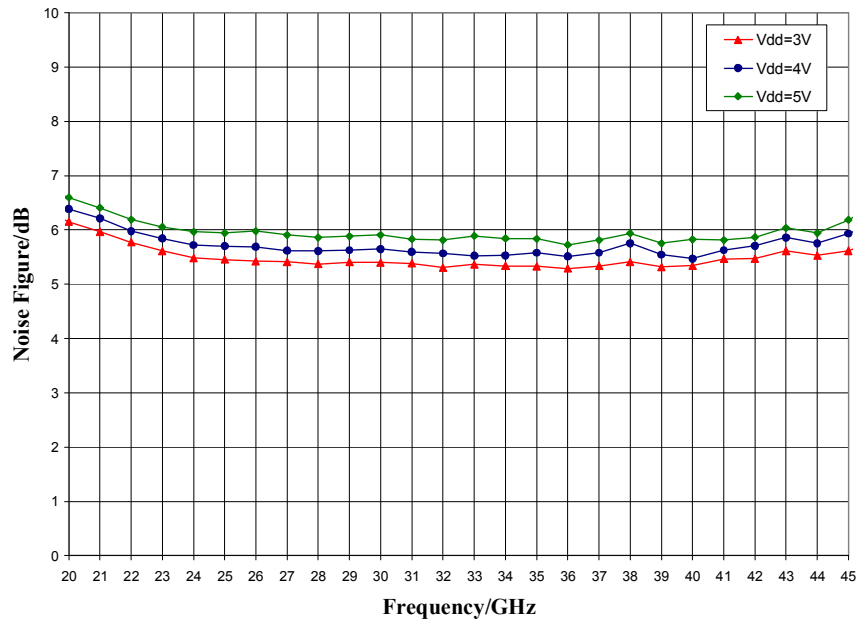

### Typical Performance

**P1dB vs. Temperature,  $V_{dd} = 5.0\text{ V}$**

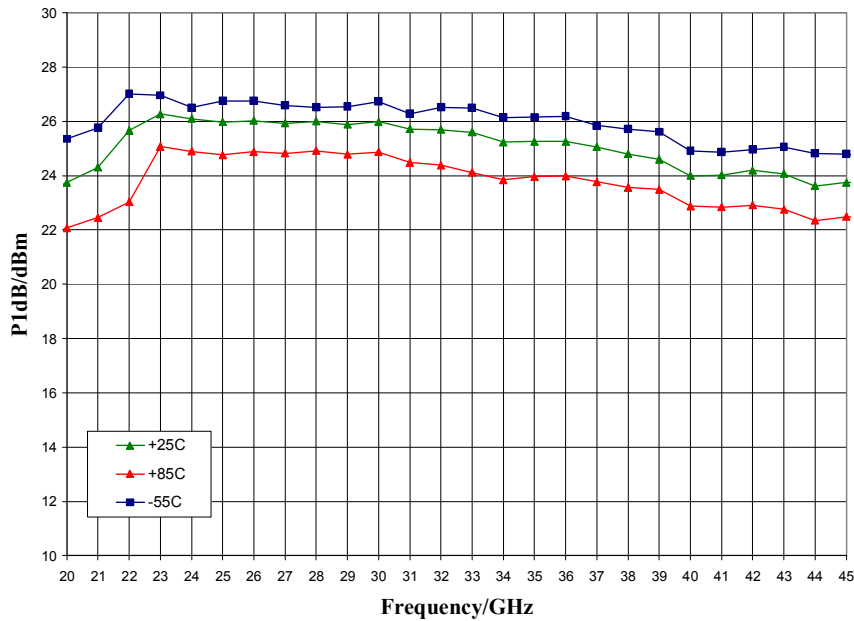

**P1dB vs  $V_{dd}$ ,  $I_{dd} = 480\text{ mA}$ ,  $T_A = 25\text{ }^\circ\text{C}$**

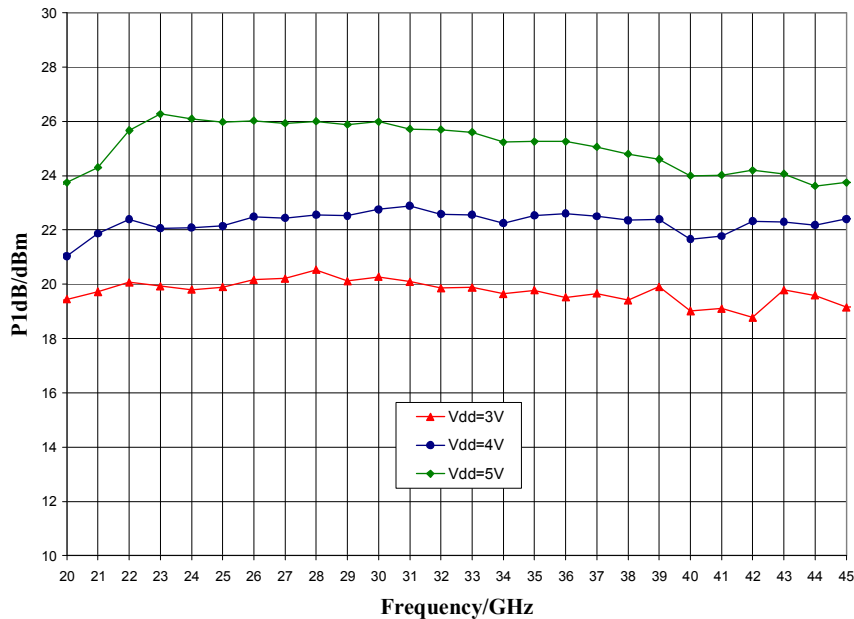

### Typical Performance

**Psat vs. Temperature,  $V_{dd} = 5.0\text{ V}$**

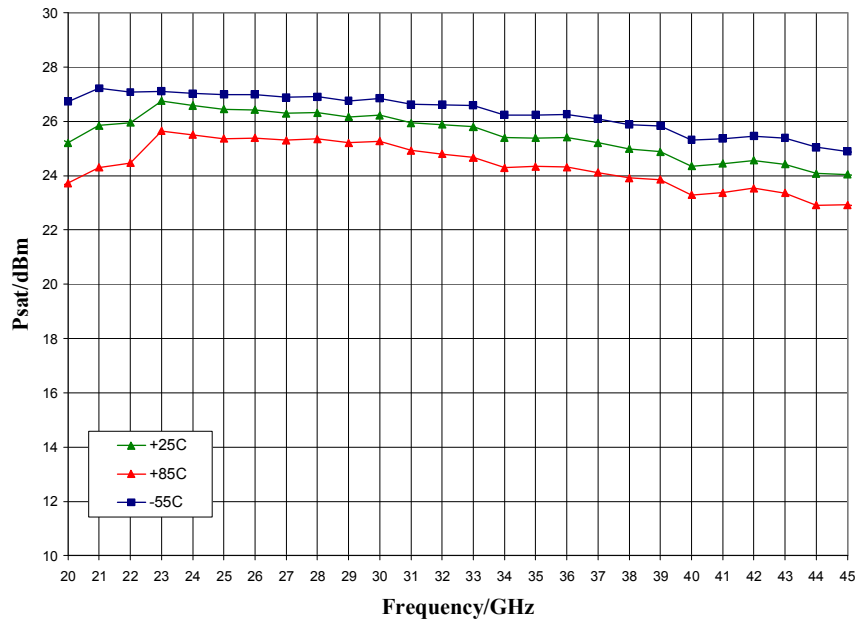

**Psat vs  $V_{dd}$ ,  $I_{dd} = 480\text{ mA}$ ,  $T_A = 25\text{ }^\circ\text{C}$**

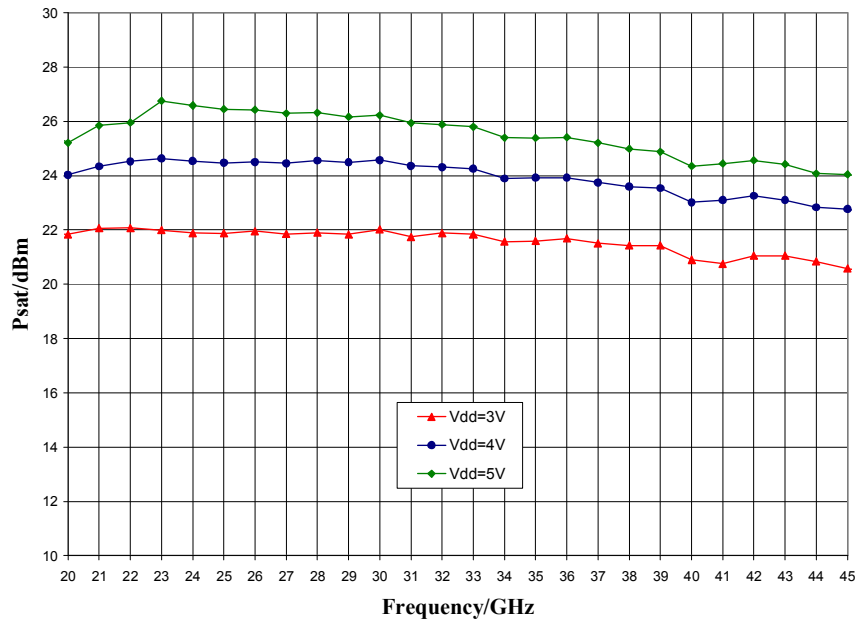

### Typical Performance

Output IP3 vs. Temperature,  $V_{dd} = 5.0\text{ V}$

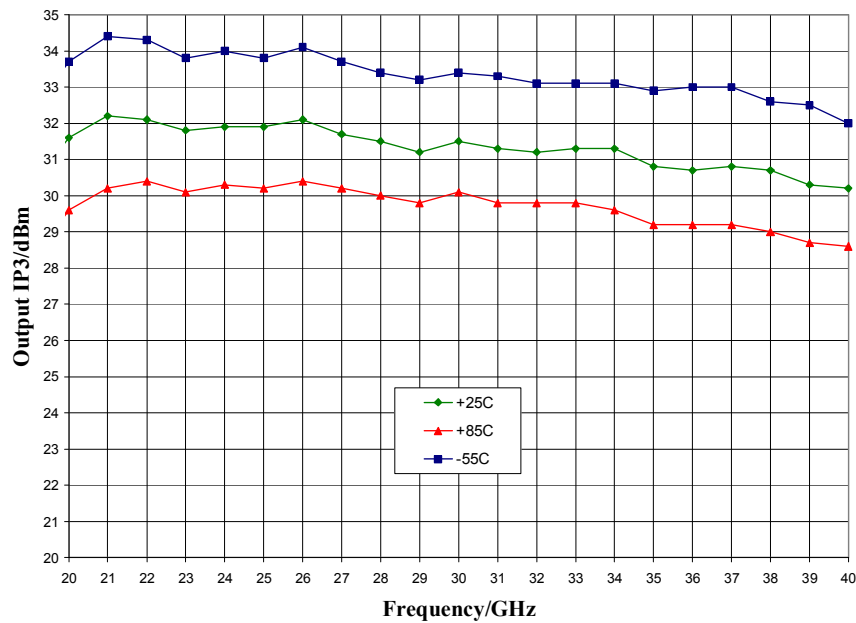

Output IP3 vs  $V_{dd}$ ,  $I_{dd} = 480\text{ mA}$ ,  $T_A = 25\text{ }^\circ\text{C}$

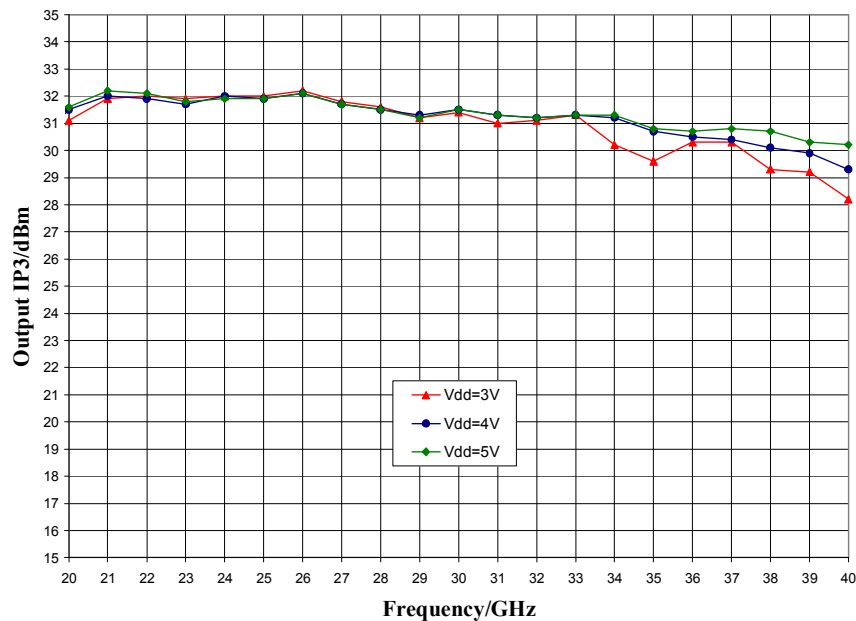

ver 1.1 1018



### Typical Performance

Detector Voltage ( $V_{ref}-V_{det}$ ),  $V_{dd} = 5.0\text{ V}$ ,  $I_{dd} = 480\text{ mA}$ ,  $F = 30\text{ GHz}$

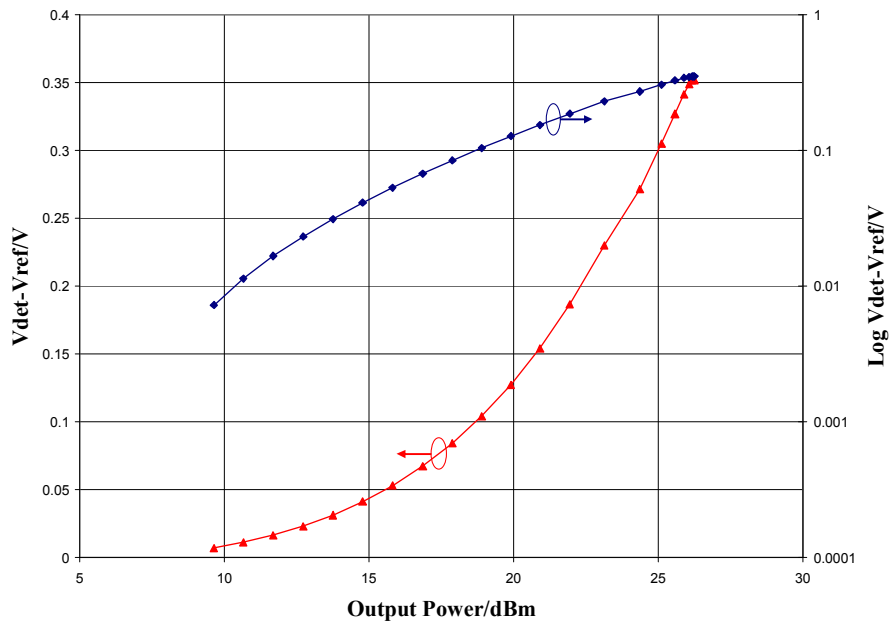

### Mechanical Information

#### Die Outline (all dimensions in microns)

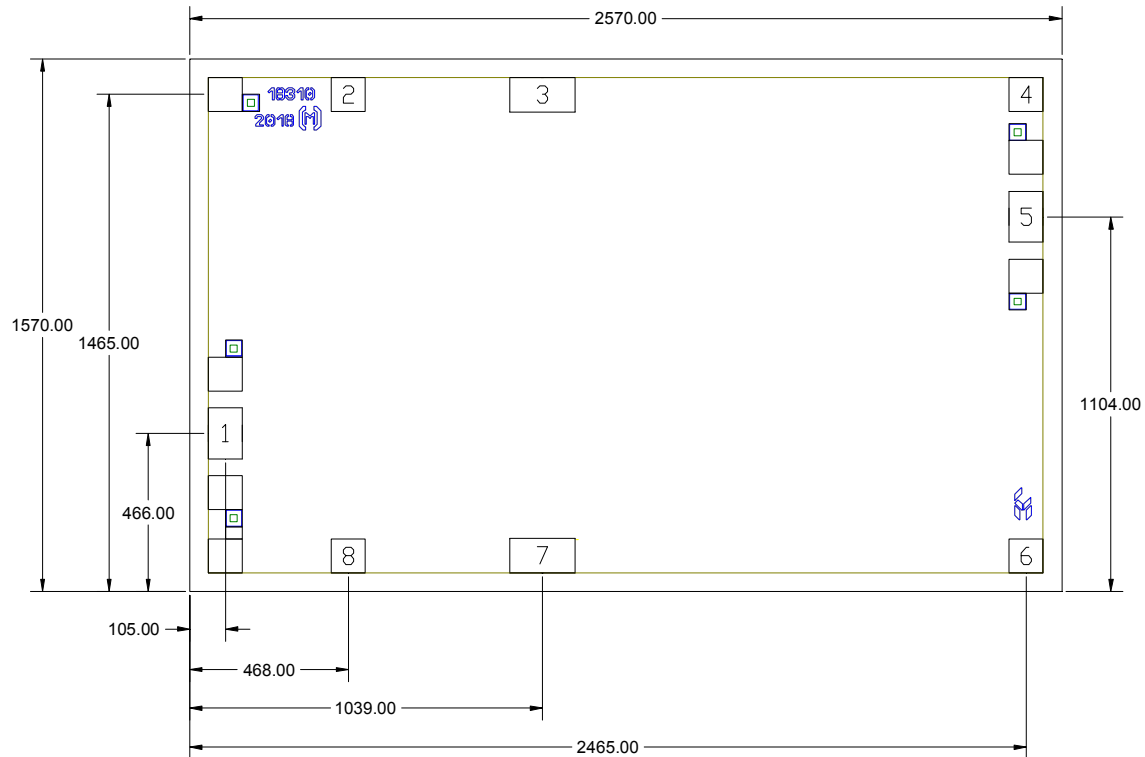

#### Notes:



1. No connection required for unlabeled pads
2. Backside is RF and DC ground
3. Backside and bond pad metal: Gold
4. Die is 70 microns thick
5. DC bond pads (2, 4, 6, 8) are 100 x 100 microns
6. DC bond pads (3, 7) are 100 x 192 microns
7. RF bond pads (1, 5) are 100 x 150 microns

### Pad Description

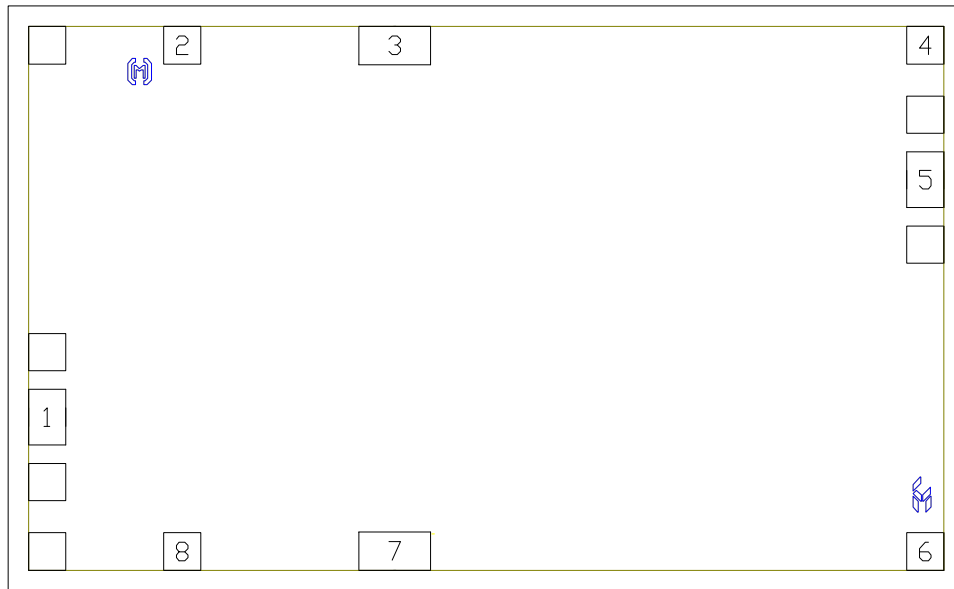
#### Pad Diagram

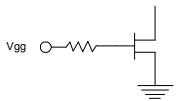
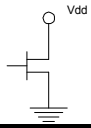

#### Functional Description

Pad	Function	Description	Schematic
1	RF in	DC blocked and 50 ohm matched	
2, 8	Vgg1, Vgg2	Power supply voltage. Decoupling and bypass caps required. Voltage need be applied to only one of these pads.	
3, 7	Vdd1, Vdd2	Power supply voltage Decoupling and bypass caps required	
4, 6	Vdet, Vref	Power detection circuit	
5	RF out	DC blocked and 50 ohm matched	
Backside	Ground	Connect to RF / DC ground	

### Applications Information

#### Assembly Guidelines

The backside of the CMD293 is RF ground. Die attach should be accomplished with electrically and thermally conductive epoxy or eutectic attach. Standard assembly procedures should be followed for high frequency devices. The top surface of the semiconductor should be made planar to the adjacent RF transmission lines, and the RF decoupling capacitors placed in close proximity to the DC connections on chip.

RF connections should be made as short as possible to reduce the inductive effect of the bond wire. Use of a 0.8 mil thermosonic wedge bonding is highly recommended as the loop height will be minimized. The RF input and output require a double bond wire as shown.

The semiconductor is 70 um thick and should be handled by the sides of the die or with a custom collet. Do not make contact directly with the die surface as this will damage the monolithic circuitry. Handle with care.

#### Assembly Diagram

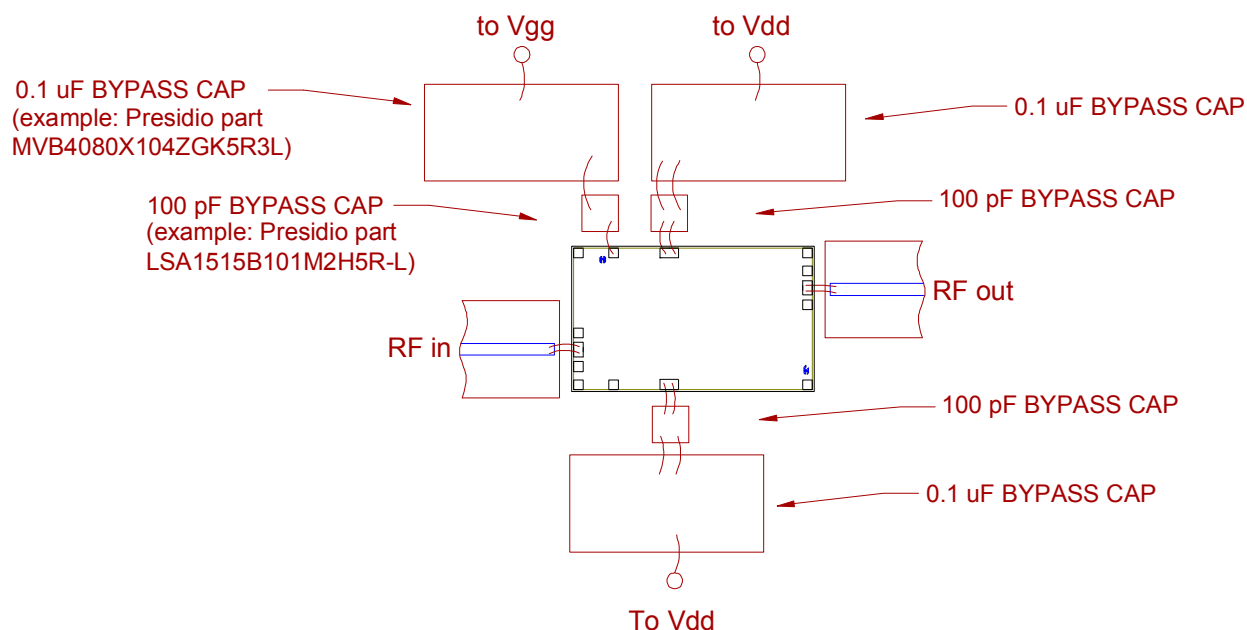

**GaAs MMIC devices are susceptible to damage from Electrostatic Discharge. Proper precautions should be observed during handling, assembly and test.**

### Applications Information

#### Application Circuit

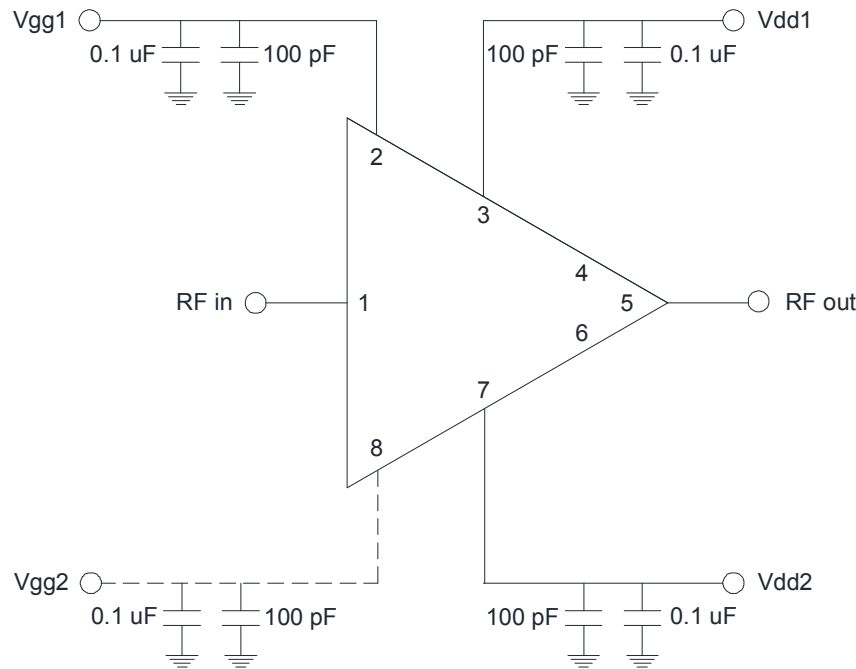

#### Biasing and Operation

The CMD293 is biased with a positive drain supply and a negative gate supply. Performance is optimized when the drain voltage is set to +5 V, though it may be set to as low as +3 V. The nominal gate voltage is -0.4 V.

Turn ON procedure:

1. Apply gate voltage  $V_{gg}$  and set to -2 V
2. Apply drain voltage  $V_{dd}$  and set to +5 V
3. Increase  $V_{gg}$  (less negative) to achieve a drain current of 480 mA

Turn OFF procedure:

1. Turn off drain voltage  $V_{dd}$
2. Turn off gate voltage  $V_{gg}$

RF power can be applied at any time.

*Please note, all information contained in this data sheet is subject to change without notice.*

ver 1.1 1018