



CMD283C3

2-6 GHz Ultra Low Noise Amplifier

Features

- ▶ Ultra low noise figure
- ▶ High gain broadband performance
- ▶ Low power dissipation
- ▶ Pb-free RoHs compliant 3x3 QFN package

Description

The CMD283C3 is a broadband MMIC low noise amplifier housed in a leadless 3x3 mm surface mount package. The CMD283C3 is ideally suited for EW and communications systems where small size and low power consumption are needed. The device is optimized for broadband performance and delivers 27 dB of gain with a corresponding noise figure of 0.6 dB at 4 GHz. The CMD283C3 is a 50 ohm matched design which eliminates the need for external DC blocks and RF port matching.

Functional Block Diagram

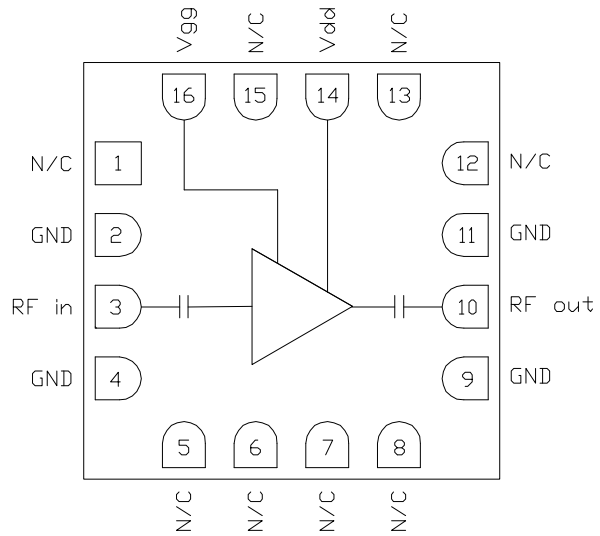

Electrical Performance – $V_{dd} = 3\text{ V}$, $V_{gg} = 1.5\text{ V}$, $T_A = 25\text{ }^\circ\text{C}$, $F = 4\text{ GHz}$

Parameter	Min	Typ	Max	Units
Frequency Range	2 – 6			GHz
Gain		27		dB
Noise Figure		0.6		dB
Input Return Loss		15		dB
Output Return Loss		10		dB
Output P1dB		16		dBm
Supply Current		42		mA

ver. 2.0 0618



CMD283C3

2-6 GHz Ultra Low Noise Amplifier

Specifications

Absolute Maximum Ratings

Parameter	Rating
Drain Voltage, V _{dd}	5.5 V
Gate Voltage, V _{gg}	3.3 V
RF Input Power	+20 dBm
Channel Temperature, T _{ch}	150 °C
Power Dissipation, P _{diss}	921 mW
Thermal Resistance, Θ_{JC}	70 °C/W
Operating Temperature	-40 to 85 °C
Storage Temperature	-55 to 150 °C

Exceeding any one or combination of the maximum ratings may cause permanent damage to the device.

Recommended Operating Conditions

Parameter	Min	Typ	Max	Units
V _{dd}	2	3	5	V
V _{gg}	0	1.5	3	V
I _{dd}		42		mA
I _{gg}		0.5		mA

Electrical performance is measured at specific test conditions. Electrical specifications are not guaranteed over all recommended operating conditions.

Electrical Specifications – V_{dd} = 3 V, V_{gg} = 1.5 V, T_A = 25 °C

Parameter	Min	Typ	Max	Min	Typ	Max	Units
Frequency Range	2 - 4			4 - 6			GHz
Gain	24	30		18	24		dB
Noise Figure		0.6	0.9		0.7	1.1	dB
Input Return Loss		10			13		dB
Output Return Loss		10			8		dB
Output P1dB		16			16		dBm
Output IP3		26			26		dBm
Supply Current	29	42	60	29	42	60	mA
Gain Temperature Coefficient		0.015			0.015		dB/°C
Noise Figure Temperature Coefficient		0.006			0.006		dB/°C

ver. 2.0 0618

Typical Performance

Broadband Performance, $V_{dd}=3\text{ V}$, $V_{gg}=1.5\text{ V}$, $I_{dd}=42\text{ mA}$, $T_A=25\text{ }^\circ\text{C}$

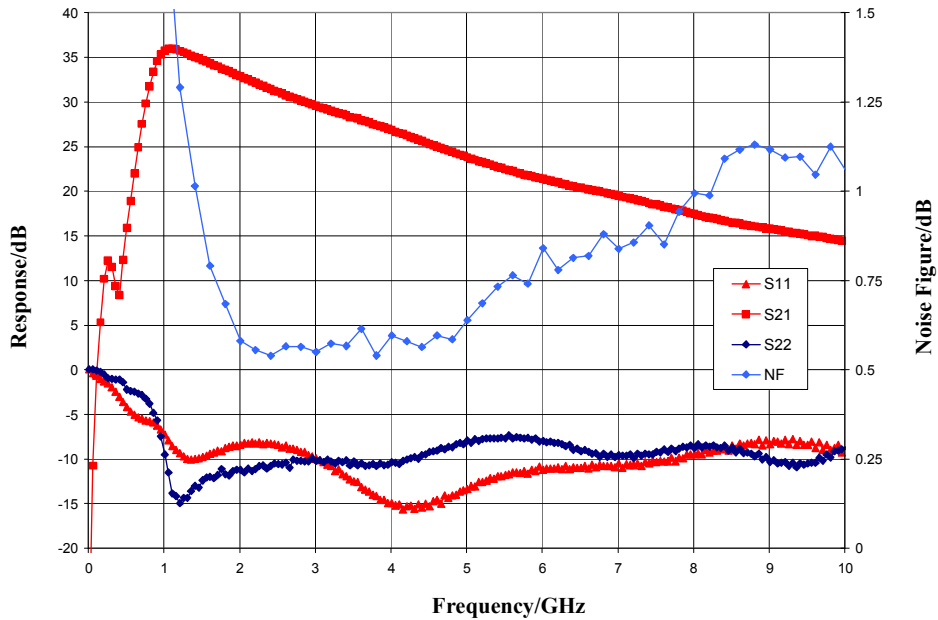

Narrow-band Performance, $V_{dd}=3\text{ V}$, $V_{gg}=1.5\text{ V}$, $I_{dd}=42\text{ mA}$, $T_A=25\text{ }^\circ\text{C}$

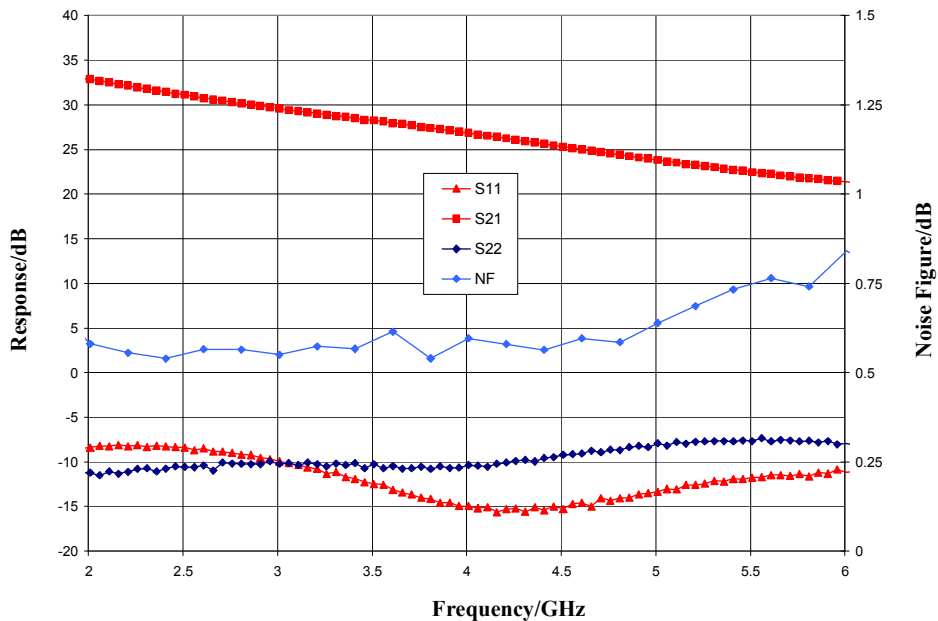

ver. 2.0 0618

Typical Performance

Gain vs. Temperature, $V_{dd}=3\text{ V}$, $V_{gg}=1.5\text{ V}$

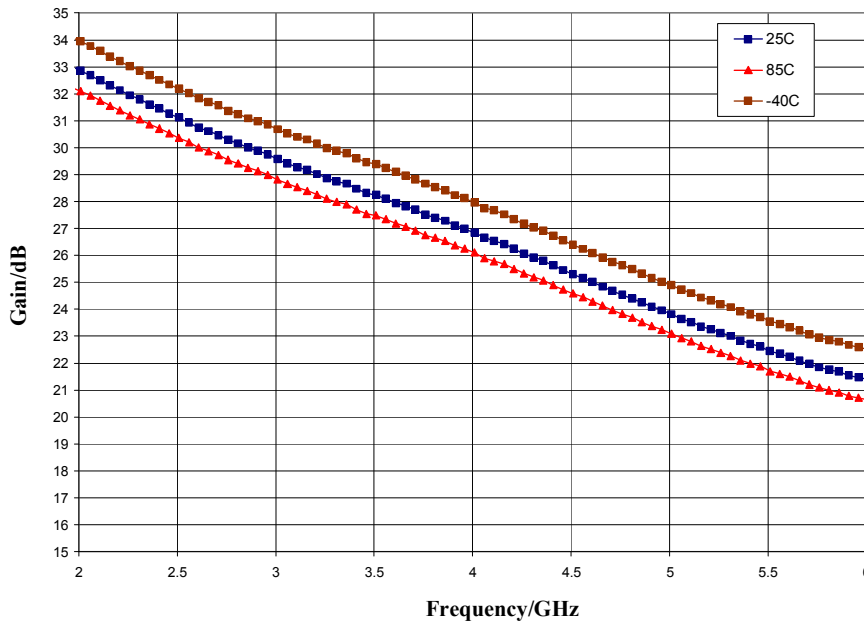

Noise Figure vs. Temperature, $V_{dd}=3\text{ V}$, $V_{gg}=1.5\text{ V}$

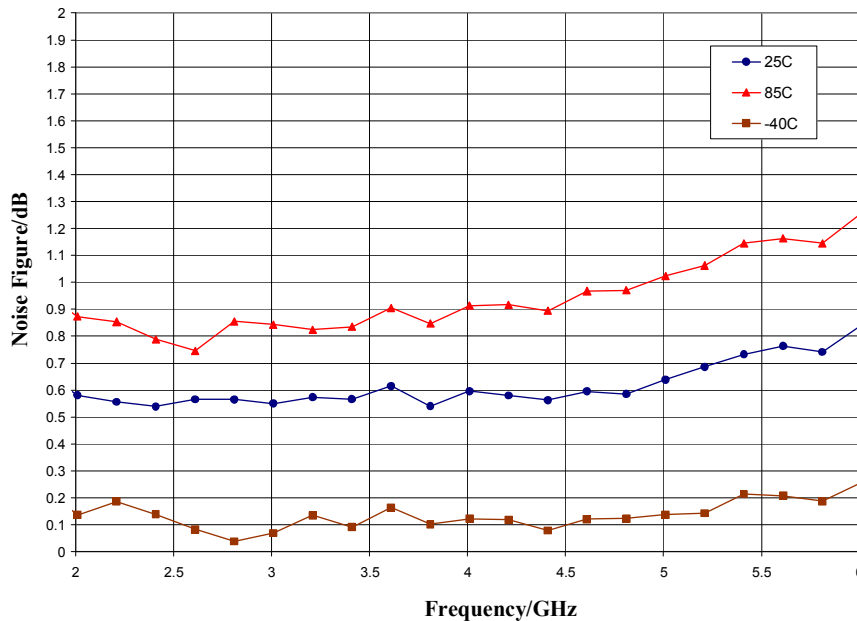

ver. 2.0 0618

Typical Performance

Output Power, $V_{dd} = 3\text{ V}$, $V_{gg} = 1.5\text{ V}$, $T_A = 25\text{ }^\circ\text{C}$

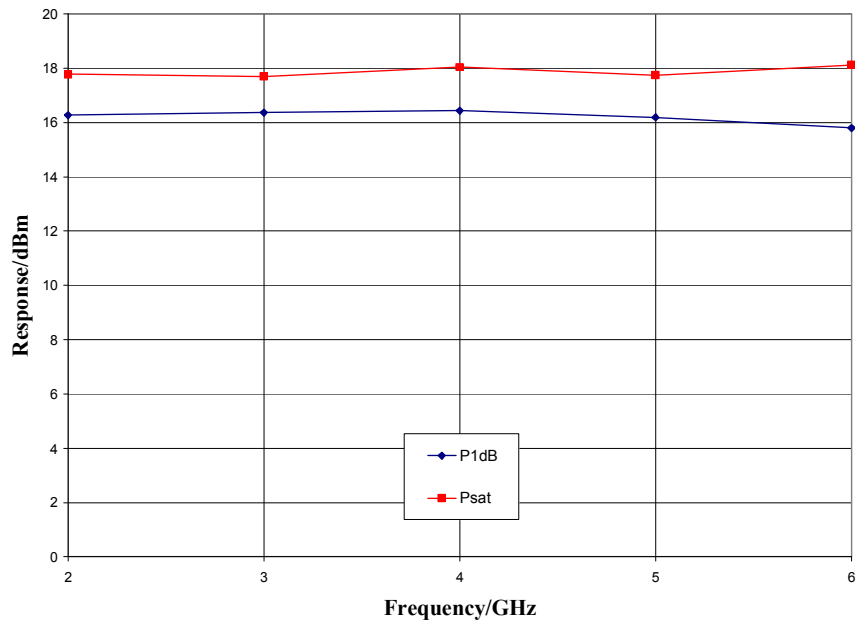

P1dB vs. Temperature, $V_{dd} = 3\text{ V}$, $V_{gg} = 1.5\text{ V}$

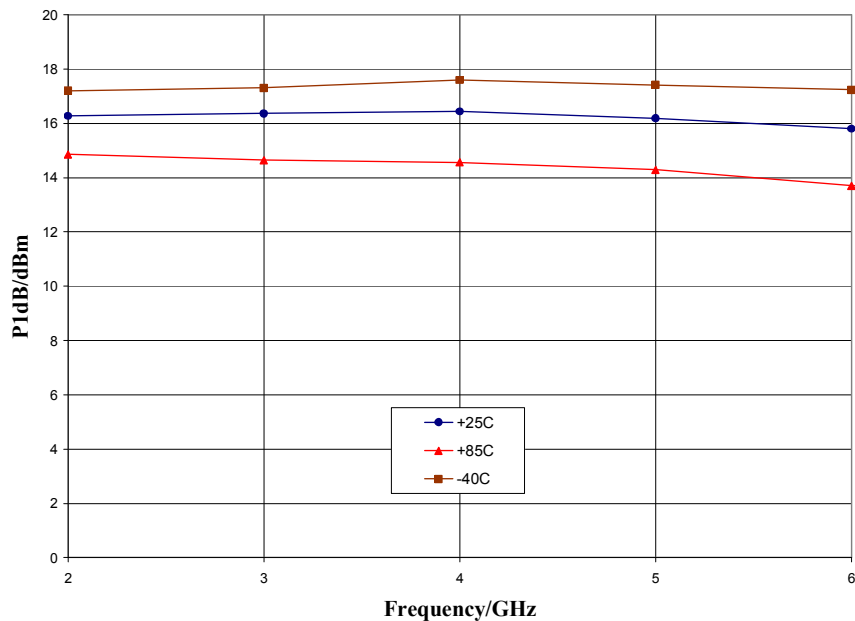

ver. 2.0 0618

Typical Performance

Output IP3 vs. Temperature, $V_{dd}=3\text{ V}$, $V_{gg}=1.5\text{ V}$

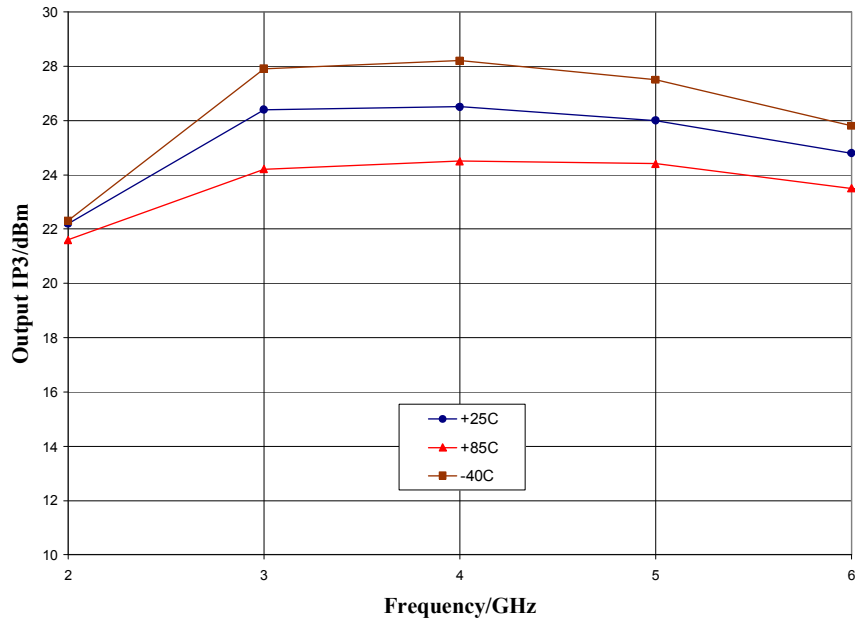

Mechanical Information

Package Information and Dimensions

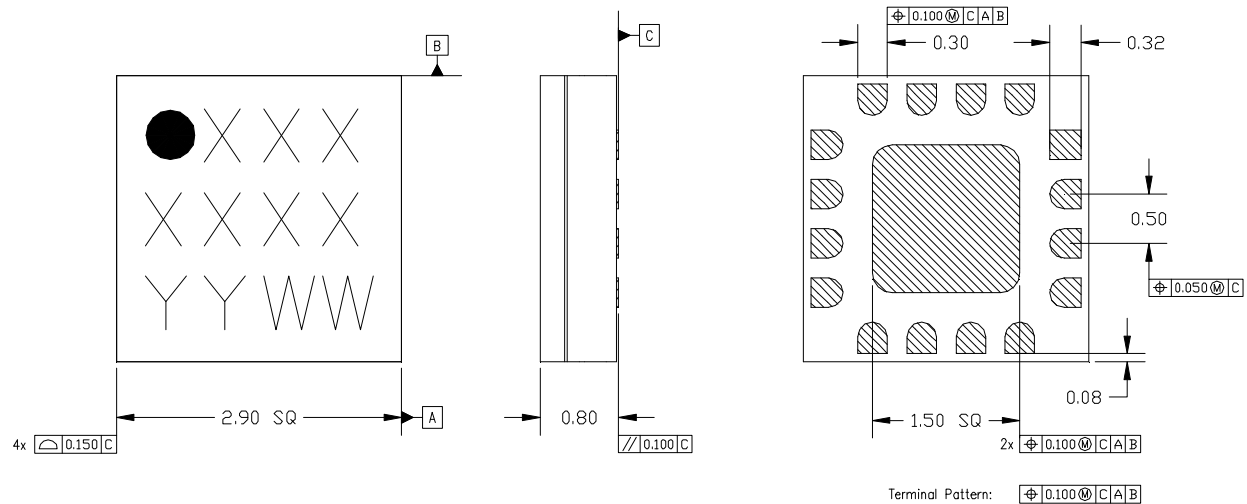

NOTES:

1. ALL DIMENSIONS SHOWN IN mm.
2. MATERIAL: BLACK ALUMINA
3. LEAD FINISH:
 - 3.1. Ni: 8.89 μ m MAX, 1.27 μ m MIN
 - 3.2. Pd: 0.17 μ m MAX, 0.07 μ m MIN
 - 3.3. Au: 0.254 μ m MAX, 0.03 μ m MIN
4. MARKING
 - 4.1. LINE 1: PART NUMBER
 - 4.1.1. EXAMPLE: CMD196C3 SHALL BE MARKED AS 196
 - 4.2. LINE 2: LOT NUMBER
 - 4.3. LINE 3: DATE CODE - LAST 2 DIGITS OF THE YEAR OF MANUFACTURE FOLLOWED BY A 2 DIGIT WEEK CODE
5. ALTERNATE PIN #1 IDENTIFIER IS A SINGLE SQUARE PAD
6. ALTERNATE DIE PADDLE MAY HAVE CHAMFERED CORNERS

Recommended PCB Land Pattern

Custom MMIC Design Services recommends that the user develop the land pattern that will provide the best design for proper solder reflow and device attach for their specific application. Please review CMDS Application Note AN 105 for a recommended land pattern approach.

Recommended Solder Reflow Profile



Custom MMIC Design Services recommends screen printing with belt furnace reflow to ensure proper solder reflow and device attach. Please review CMDS Application Note AN 102 for a recommended solder reflow profile.

Pin Description

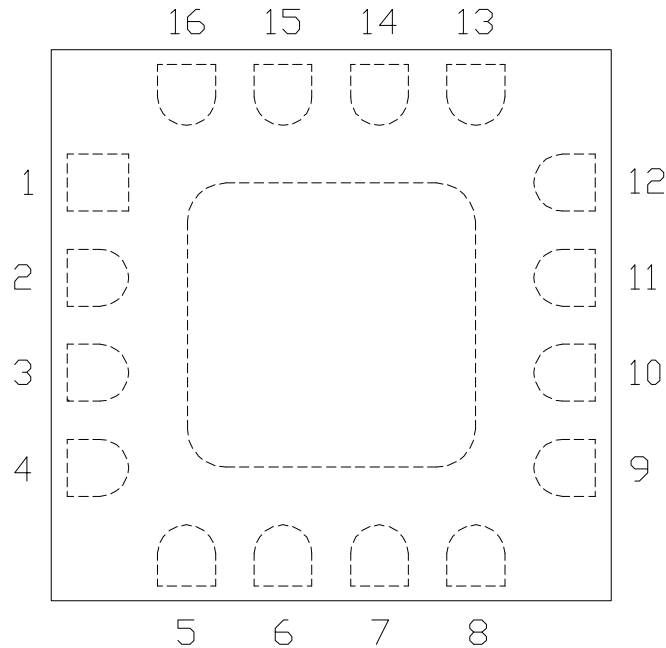
Pin Diagram

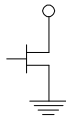
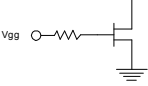

Functional Description

Pin	Function	Description	Schematic
1, 5-8, 12, 13, 15	N/C	No connection required. These pins may be connected to RF/DC ground.	
2, 4, 9, 11 and die paddle	Ground	Connect to RF / DC ground	
3	RF in	DC blocked and 50 ohm matched	
10	RF out	DC blocked and 50 ohm matched	
14	Vdd	Power supply voltage Decoupling and bypass caps required	
16	Vgg	Power supply voltage Decoupling and bypass caps required	

ver. 2.0 0618

Applications Information

Application Circuit

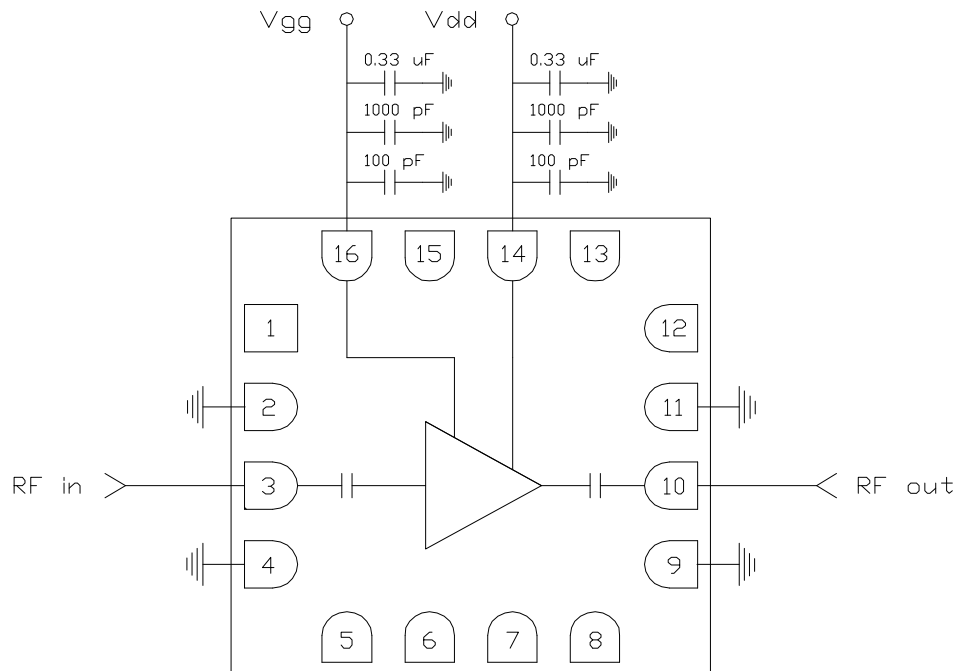

Biasing and Operation

The CMD283C3 is biased with a 3 V positive drain supply and a 1.5 V positive gate supply. Turn ON procedure:

1. Apply drain voltage V_{dd} and set to +3 V
2. Apply gate voltage V_{gg} and set to +1.5 V

Turn OFF procedure:

1. Turn off gate voltage V_{gg}
2. Turn off drain voltage V_{dd}

Refer to Application Note 103: Amplifier Biasing Techniques for instructions on how to implement a single supply biasing scheme.

RF power can be applied at any time.

GaAs MMIC devices are susceptible to damage from Electrostatic Discharge. Proper precautions should be observed during handling, assembly and test.

ver. 2.0 0618

Applications Information

Evaluation Board

The circuit board shown has been developed for optimized assembly at CMDS. A sufficient number of via holes should be used to connect the top and bottom ground planes. As surface mount processes vary, careful process development is recommended.

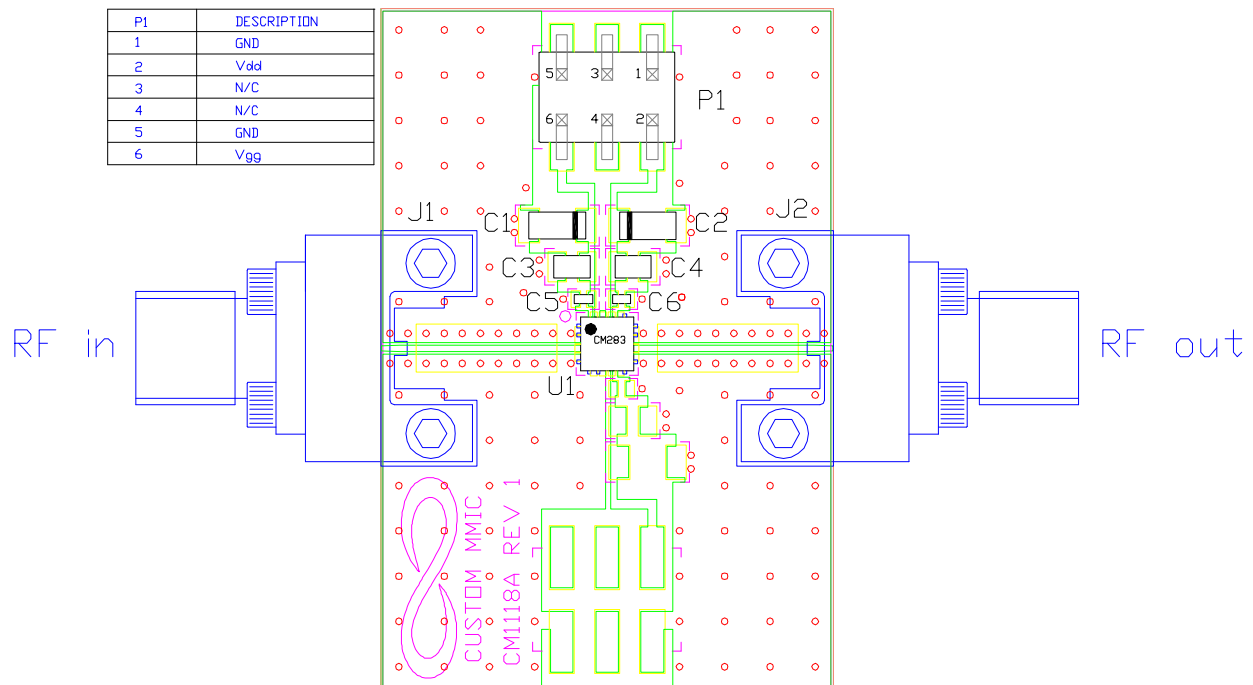

Designator	Value	Description
J1, J2		SMA End Launch Connector
P1		6 Pin Header
C1, C2	0.33 μ F	Capacitor, Tantalum
C3, C4	1000 pF	Capacitor, 0603
C5, C6	100 pF	Capacitor, 0402
U1		CMD283C3 Low Noise Amplifier
PCB		CM118A Evaluation PCB

Please note, all information contained in this data sheet is subject to change without notice.

ver. 2.0 0618