



CMD281C3

DC-22 GHz 2-bit Digital Attenuator

Features

- ▶ Wideband performance
- ▶ Low insertion loss
- ▶ 6 dB attenuation range
- ▶ Pb-free RoHs compliant 3x3 QFN package

Description

The CMD281C3 is a negative controlled, wideband GaAs MMIC 2-bit digital attenuator housed in a leadless 3x3 mm surface mount package. Each bit of the attenuator is controlled by a single voltage of either 0 V or -5 V. The attenuator bit values are 2 dB and 4 dB, for a total attenuation of 6 dB. The CMD281C3 has a low insertion loss of 1.5 dB at 10 GHz and the attenuation accuracy is typically 0.1 dB step error. The CMD281C3 is a 50 ohm matched design which eliminates the need for RF port matching.

Functional Block Diagram

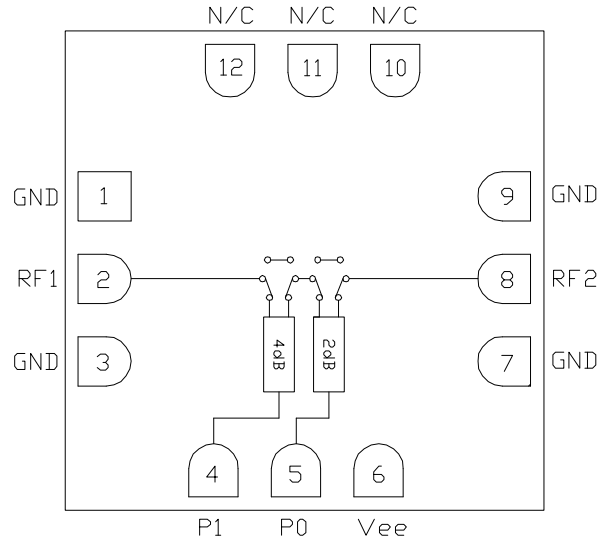

Electrical Performance – $V_{ee} = -5\text{ V}$, $V_{ctl} = 0 / -5\text{ V}$, $T_A = 25\text{ }^\circ\text{C}$, $F = 10\text{ GHz}$

Parameter	Min	Typ	Max	Units
Frequency Range	DC – 22			GHz
Insertion Loss		1.5		dB
Attenuation Range		6		dB
Input Return Loss		17		dB
Output Return Loss		17		dB
Input P0.1dB		28		dBm
Input IP3		42		dBm
Switching Speed		25		ns

ver 1.0 0718

Specifications

Absolute Maximum Ratings

Parameter	Rating
Bias Voltage, V _{ee}	-8 V
Control Voltage, V _{ctl}	-8 V
RF Input Power	+27 dBm
Thermal resistance, Θ_{JC}	122 °C/W
Operating Temperature	-40 to 85 °C
Storage Temperature	-55 to 150 °C

Exceeding any one or combination of the maximum ratings may cause permanent damage to the device.

Recommended Operating Conditions

Parameter	Min	Typ	Max	Units
V _{ee}	-5.5	-5	-2.5	V

Electrical performance is measured at specific test conditions. Electrical specifications are not guaranteed over all recommended operating conditions.

Truth Table

Control Voltage Input		Attenuation State RF1-RF2 (dB)
P0 2 dB	P1 4 dB	
Low	Low	Reference (insertion loss)
High	Low	2
Low	High	4
High	High	6

Control Voltage

State	Bias Condition
High	V _{ee} ± 0.3 V
Low	0 ± 0.3 V



CMD281C3

DC-22 GHz 2-bit Digital Attenuator

Specifications

Electrical Specifications, $V_{ee} = -5\text{ V}$, $V_{ctl} = 0/-5\text{ V}$, $T_A = 25\text{ }^\circ\text{C}$

Parameter	Min	Typ	Max	Min	Typ	Max	Min	Typ	Max	Units
Frequency Range	DC - 10			10 - 18			18 - 22			GHz
Insertion Loss		1.2	2		1.5	2.6		1.6	2.7	dB
Attenuation Range		6			6			6		dB
Attenuation Accuracy		0.15	0.3		0.5	0.8		0.8	1.6	dB
Input Return Loss		20			12			10		dB
Output Return Loss		20			12			12		dB
Input P0.1dB		28			28			28		dBm
Input IP3		42			42			42		dBm

Note: Specification applies to major states

ver 1.0 0718

Typical Performance

Insertion Loss versus Temperature

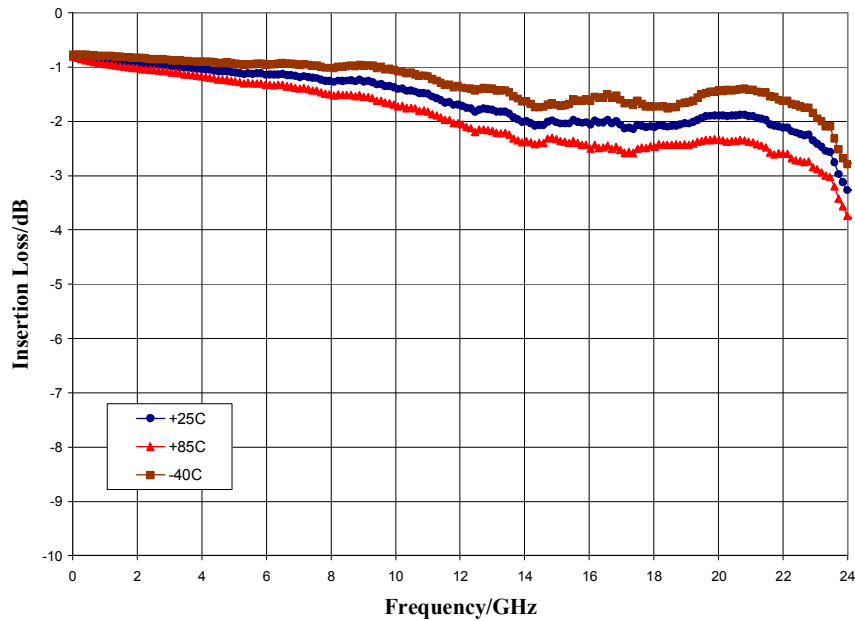

Normalized Attenuation (all states), $T_A = 25\text{ }^\circ\text{C}$

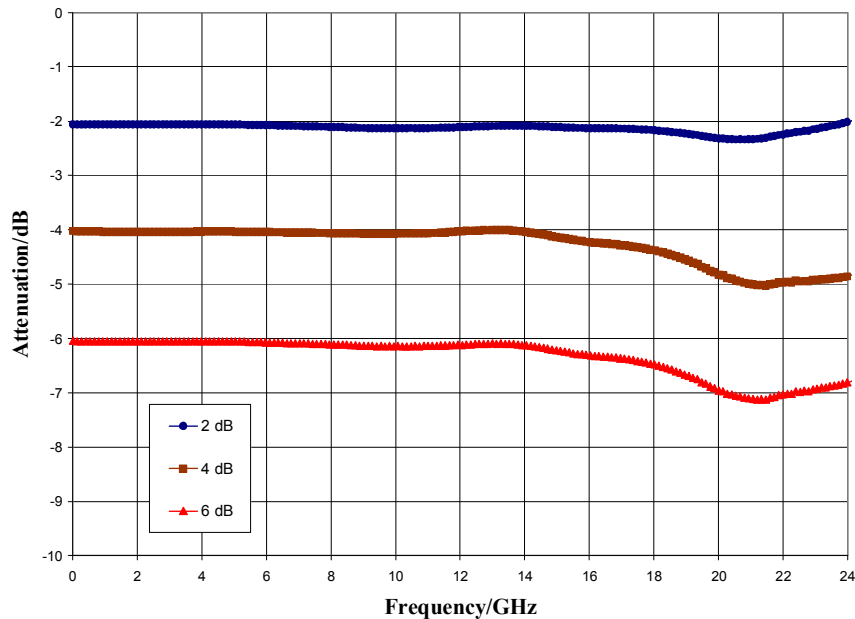

ver 1.0 0718

Typical Performance

Input Return Loss (all states), $T_A = 25\text{ }^\circ\text{C}$

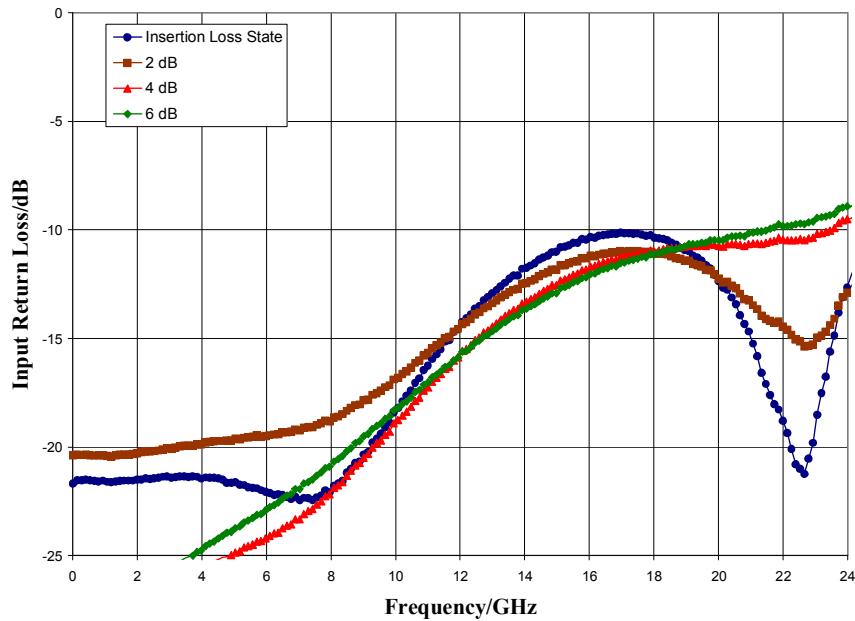

Output Return Loss (all states), $T_A = 25\text{ }^\circ\text{C}$

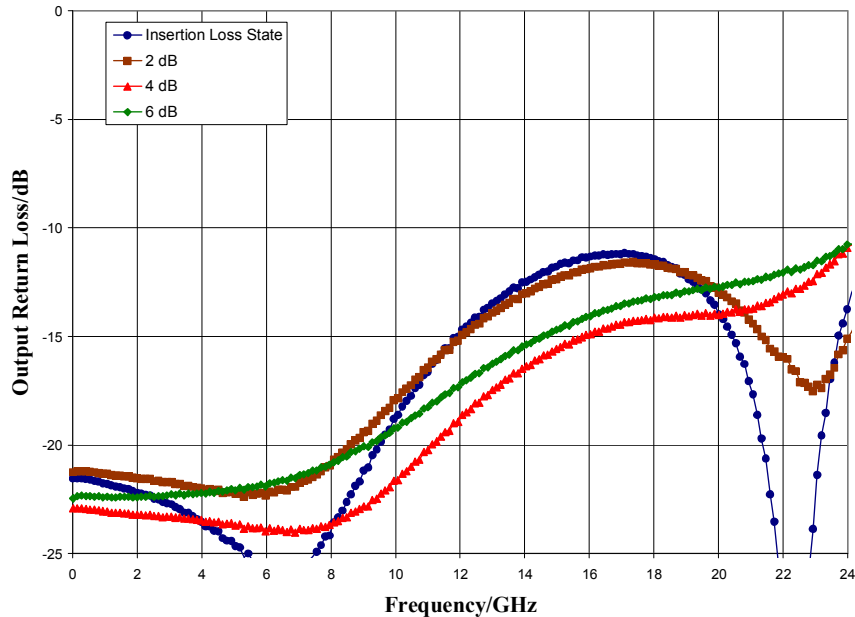

ver 1.0 0718

Typical Performance

Bit Error versus Frequency, $T_A = 25\text{ }^\circ\text{C}$

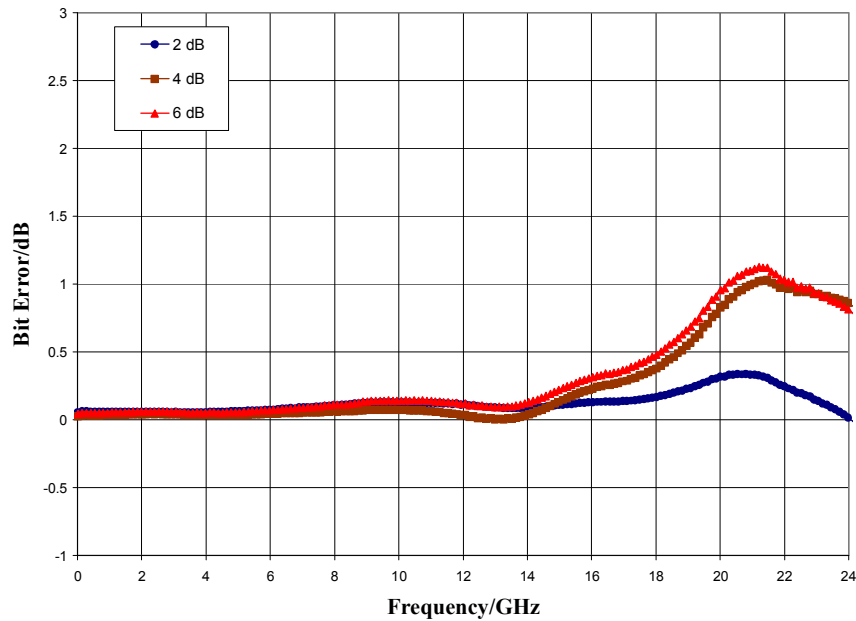

Relative Phase versus Frequency, $T_A = 25\text{ }^\circ\text{C}$

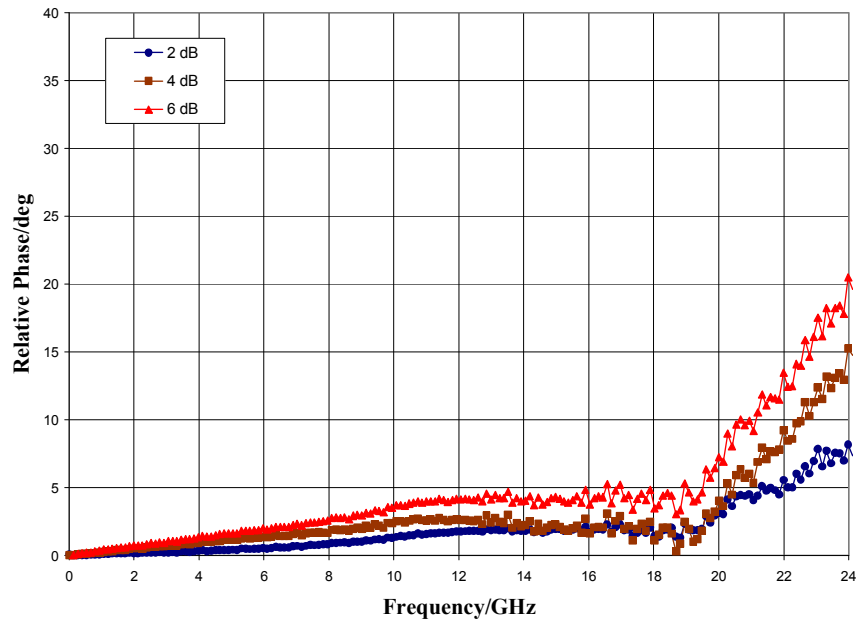

ver 1.0 0718

Typical Performance

Input Power for 0.1 dB Compression (insertion loss state)

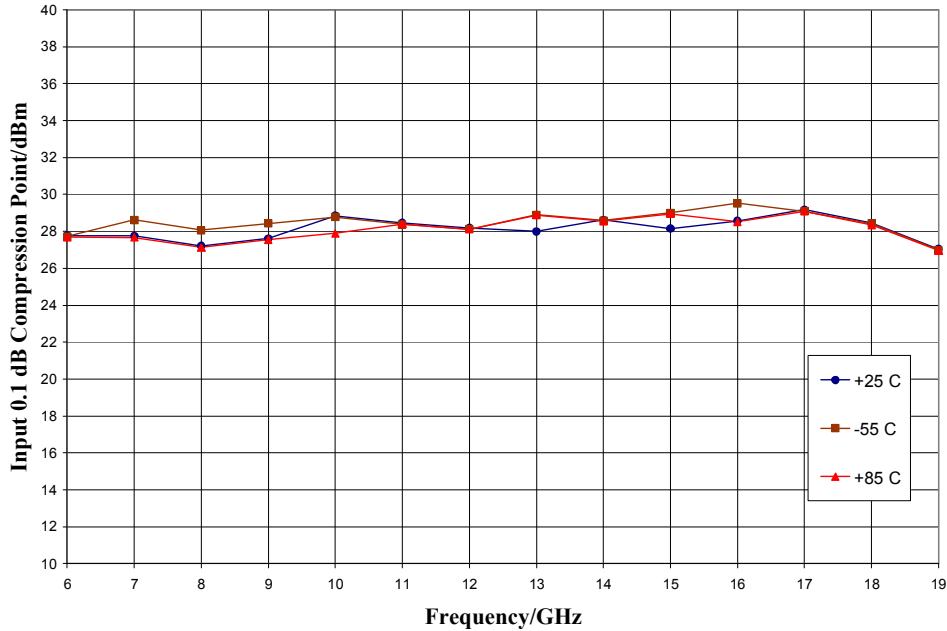

Input IP3 versus Temperature (insertion loss state)

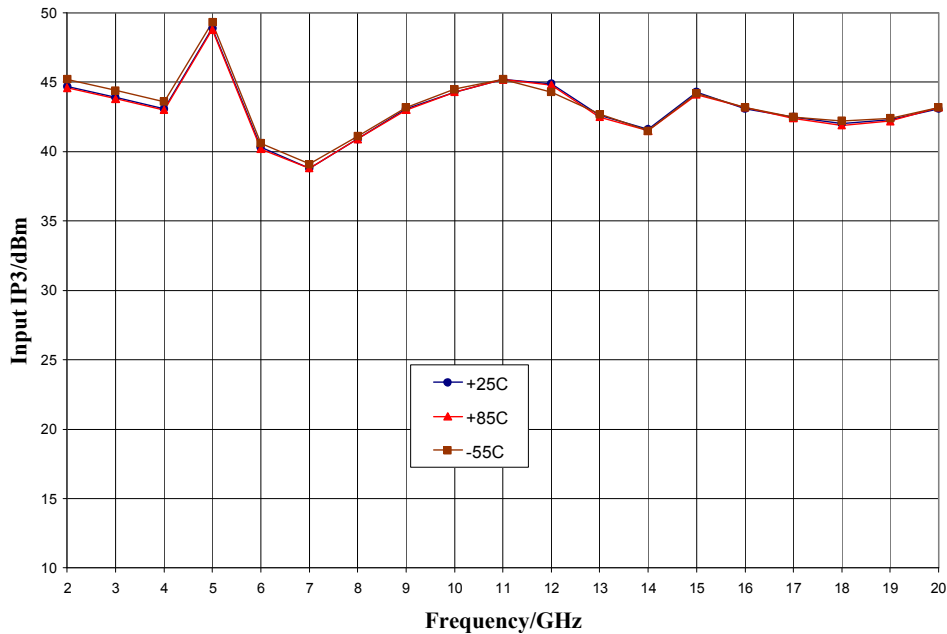

ver 1.0 0718

Mechanical Information

Package Information and Dimensions

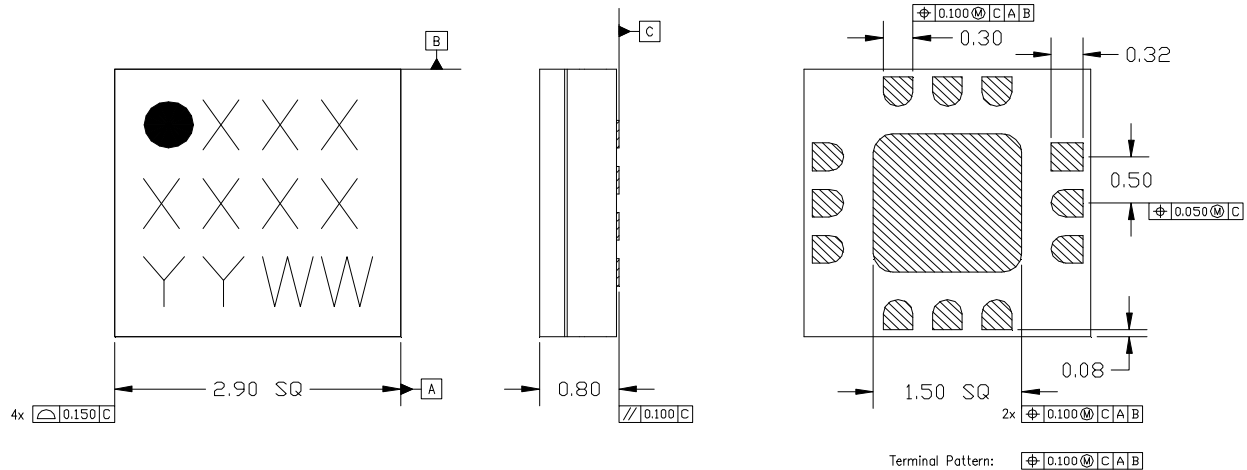

NOTES:

1. ALL DIMENSIONS SHOWN IN mm.
2. MATERIAL: BLACK ALUMINA
3. LEAD FINISH:
 - 3.1. Ni: 8.89um MAX, 1.27um MIN
 - 3.2. Pd: 0.17um MAX, 0.07um MIN
 - 3.3. Au: 0.254um MAX, 0.03um MIN
4. MARKING
 - 4.1. LINE 1: PART NUMBER
 - 4.1.1. EXAMPLE: CMD177C3 SHALL BE MARKED AS 177
 - 4.2. LINE 2: LDT NUMBER
 - 4.3. LINE 3: DATE CODE - LAST 2 DIGITS OF THE YEAR OF MANUFACTURE FOLLOWED BY A 2 DIGIT WEEK CODE
5. ALTERNATE PIN #1 IDENTIFIER IS A SINGLE SQUARE PAD
6. ALTERNATE DIE PADDLE MAY HAVE CHAMFERED CORNERS

Recommended PCB Land Pattern

Custom MMIC recommends that the user develop the land pattern that will provide the best design for proper solder reflow and device attach for their specific application. Please review Custom MMIC Application Note AN 105 for a recommended land pattern approach.

Recommended Solder Reflow Profile

Custom MMIC recommends screen printing with belt furnace reflow to ensure proper solder reflow and device attach. Please review Custom MMIC Application Note AN 102 for a recommended solder reflow profile.

Pin Description

Pin Diagram

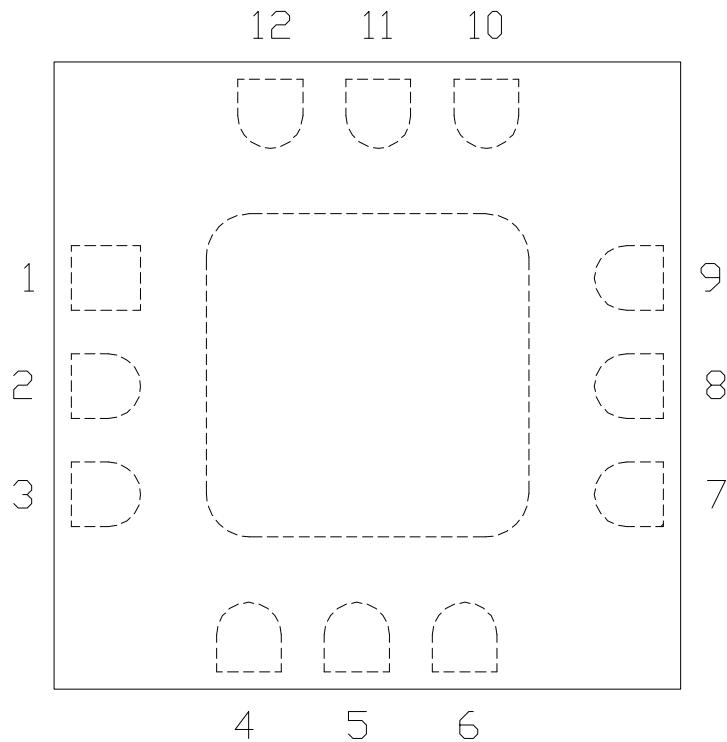

Functional Description

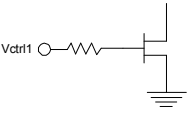
Pad	Function	Description	Schematic
1, 3, 7, 9 and die paddle	Ground	Connect to RF / DC ground	
2, 8	RF1, RF2	50 ohm matched	
4, 5	P1, P0	Bit control voltages, see truth table for values	
6	Vee	Negative bias -5V	
10-12	N/C	No connection required. These pins may be connected to RF/DC ground.	

ver 1.0 0718

Applications Information

Evaluation Board

The circuit board shown has been developed for optimized assembly at Custom MMIC. A sufficient number of via holes should be used to connect the top and bottom ground planes. As surface mount processes vary, careful process development is recommended.

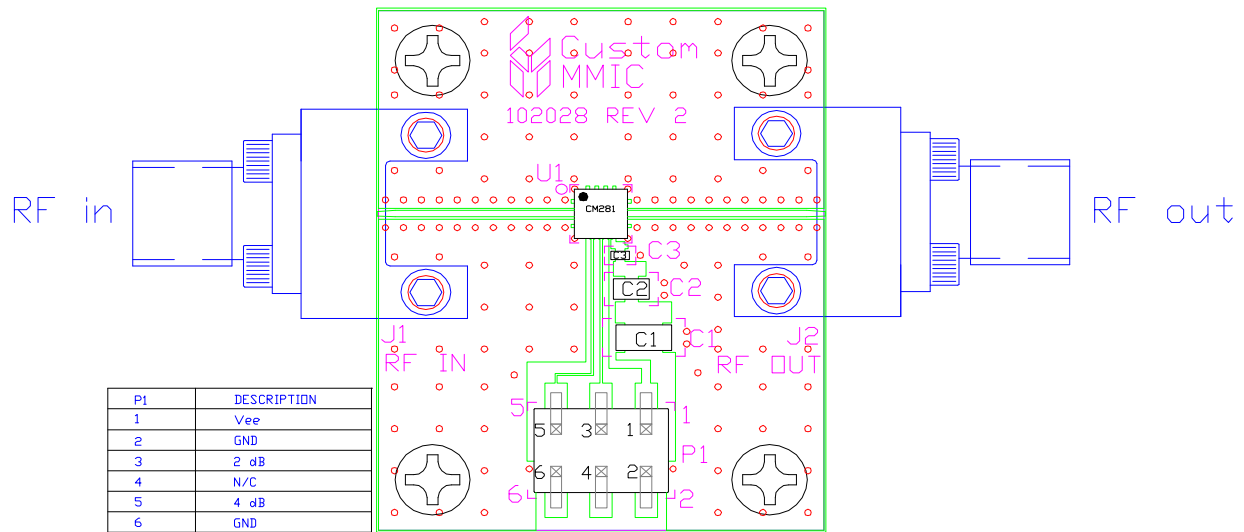

Designator	Value	Description
J1, J2		SMA End Launch Connector
P1		6 Pin Header
C1	0.33 μ F	Capacitor, Tantalum
C2	1000 pF	Capacitor, 0603
C3	100 pF	Capacitor, 0402
U1		CMD281C3 DATT
PCB		102028 Evaluation PCB

GaAs MMIC devices are susceptible to damage from Electrostatic Discharge. Proper precautions should be observed during handling, assembly and test.

Please note, all information contained in this data sheet is subject to change without notice.

ver 1.0 0718