

Features

- ▶ Ultra wideband performance
- ▶ Low insertion loss
- ▶ Wide attenuation range
- ▶ Small die size

Description

The CMD281 is negative controlled, wideband GaAs MMIC 2-bit digital attenuator die which operates from DC to 40 GHz. Each bit of the attenuator is controlled by a single voltage of either 0 V or -5 V. The attenuator bit values are 2 dB and 4 dB, for a total attenuation of 6 dB. The CMD281 has a low insertion loss of 1.2 dB at 18 GHz and the attenuation accuracy is typically 0.1 dB step error. The CMD281 is a 50 ohm matched design which eliminates the need for RF port matching. The CMD281 offers full passivation for increased reliability and moisture protection.

Functional Block Diagram

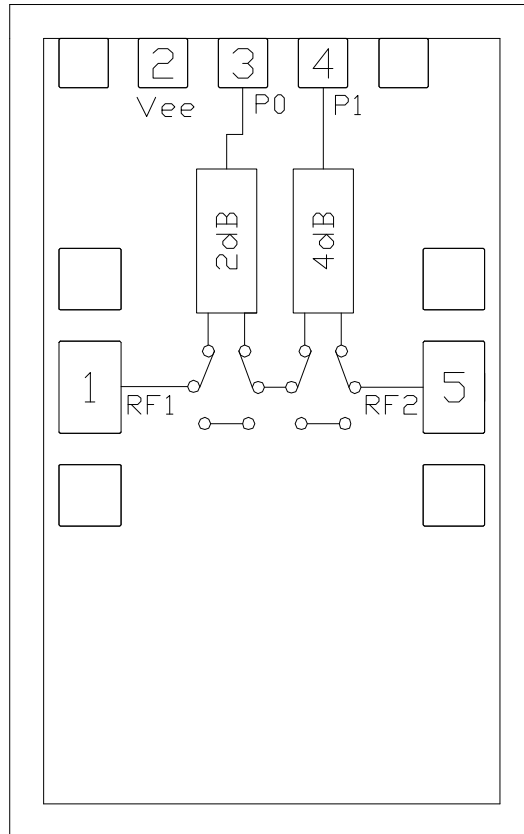

Electrical Performance – $V_{ee} = -5\text{ V}$, $V_{ctl} = 0 / -5\text{ V}$, $T_A = 25\text{ }^\circ\text{C}$, $F = 18\text{ GHz}$

| Parameter | Min | Typ | Max | Units |
|--------------------|---------|-----|-----|-------|
| Frequency Range | DC – 40 | | | GHz |
| Insertion Loss | | 1.2 | | dB |
| Attenuation Range | | 6 | | dB |
| Input Return Loss | | 20 | | dB |
| Output Return Loss | | 20 | | dB |
| Input P0.1dB | | 28 | | dBm |
| Input IP3 | | 42 | | dBm |
| Switching Speed | | 25 | | ns |

ver 1.1 0718

Specifications

Absolute Maximum Ratings

| Parameter | Rating |
|-----------------------------------|---------------|
| Bias Voltage, V _{ee} | -8 V |
| Control Voltage, V _{ctl} | -8 V |
| RF Input Power | +27 dBm |
| Thermal resistance, Θ_{JC} | 122 °C/W |
| Operating Temperature | -55 to 85 °C |
| Storage Temperature | -55 to 150 °C |

Exceeding any one or combination of the maximum ratings may cause permanent damage to the device.

Recommended Operating Conditions

| Parameter | Min | Typ | Max | Units |
|-----------------|------|-----|------|-------|
| V _{ee} | -5.5 | -5 | -2.5 | V |

Electrical performance is measured at specific test conditions. Electrical specifications are not guaranteed over all recommended operating conditions.

Truth Table

| Control Voltage Input | | Attenuation State RF1-RF2 (dB) |
|-----------------------|------------|--------------------------------------|
| P0 2 dB | P1 4 dB | |
| Low | Low | Reference (insertion loss) |
| High | Low | 2 |
| Low | High | 4 |
| High | High | 6 |

Control Voltage

| State | Bias Condition |
|-------|-------------------------|
| High | V _{ee} ± 0.3 V |
| Low | 0 ± 0.3 V |

Specifications

Electrical Specifications, $V_{ee} = -5\text{ V}$, $V_{ctl} = 0/-5\text{ V}$, $T_A = 25\text{ }^\circ\text{C}$

| Parameter | Min | Typ | Max | Min | Typ | Max | Units |
|----------------------|---------|-----|-----|---------|-----|-----|-------|
| Frequency Range | DC - 20 | | | 20 - 40 | | | GHz |
| Insertion Loss | | 1 | 1.7 | | 1.7 | 2.8 | dB |
| Attenuation Range | | 6 | | | 6 | | dB |
| Attenuation Accuracy | | 0.1 | 0.2 | | 0.2 | 0.5 | dB |
| Input Return Loss | | 20 | | | 15 | | dB |
| Output Return Loss | | 20 | | | 15 | | dB |
| Input P0.1dB | | 28 | | | 28 | | dBm |
| Input IP3 | | 42 | | | 42 | | dBm |

Note: Specification applies to major states

Typical Performance

Insertion Loss versus Temperature

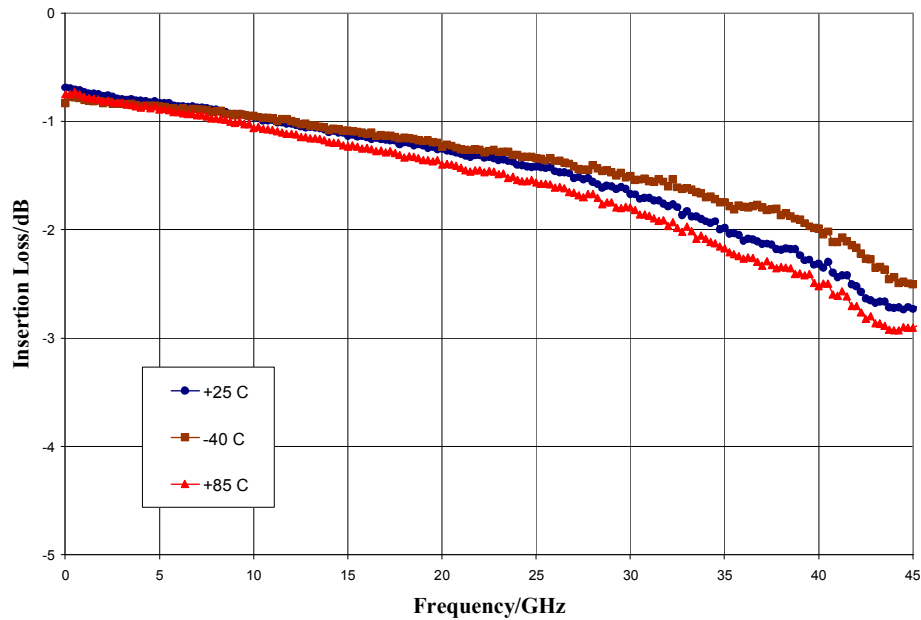

Normalized Attenuation (all states), $T_A = 25^\circ\text{C}$

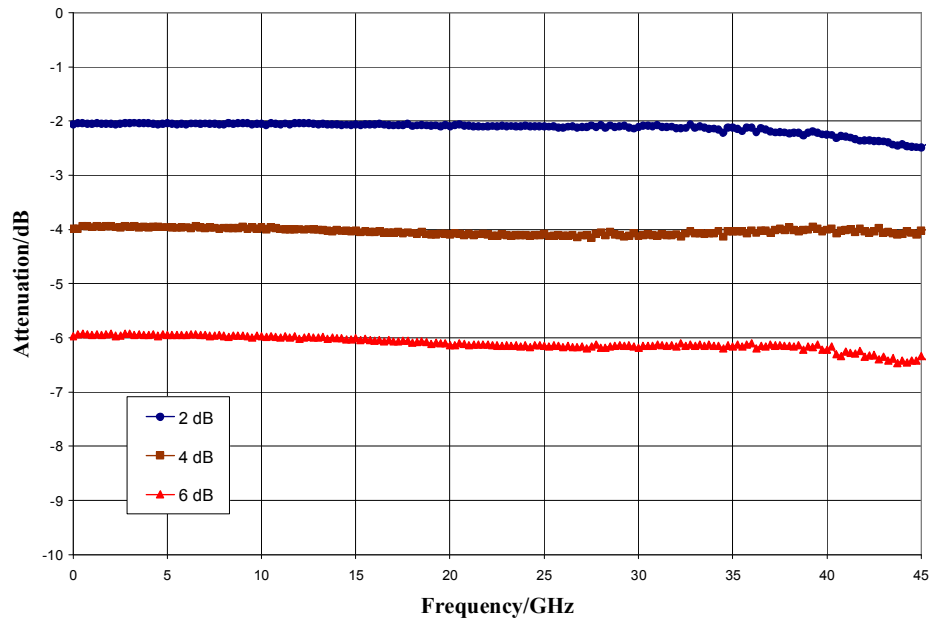

ver 1.1 0718

Typical Performance

Input Return Loss (all states), $T_A = 25\text{ }^\circ\text{C}$

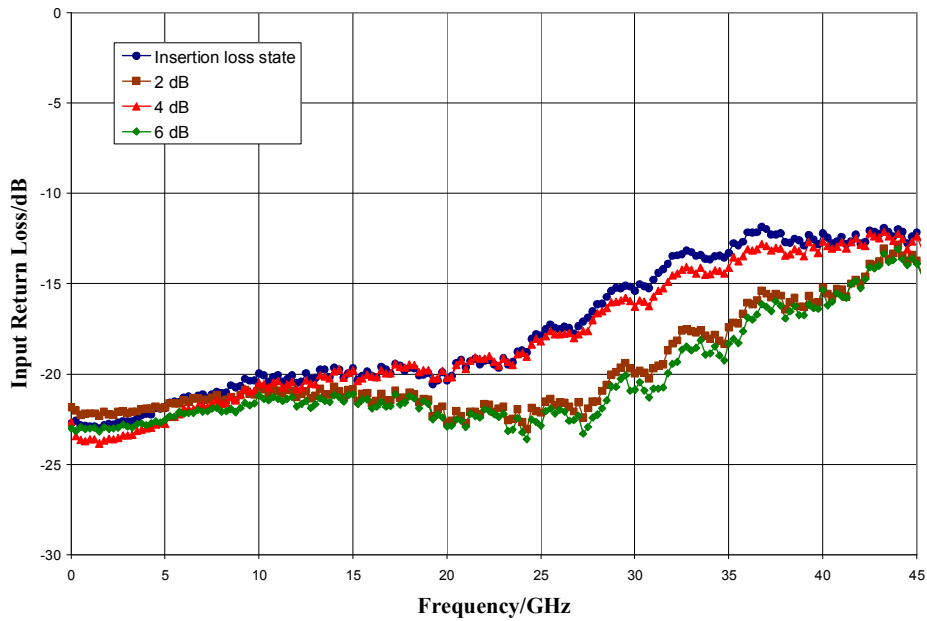

Output Return Loss (all states), $T_A = 25\text{ }^\circ\text{C}$

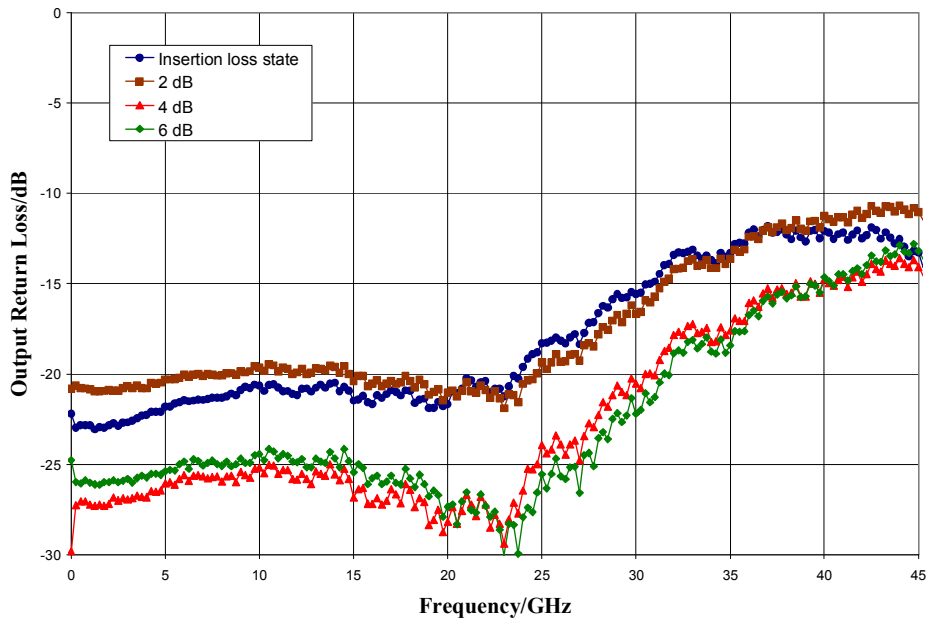

ver 1.1 0718

Typical Performance

Bit Error versus Frequency, $T_A = 25\text{ }^\circ\text{C}$

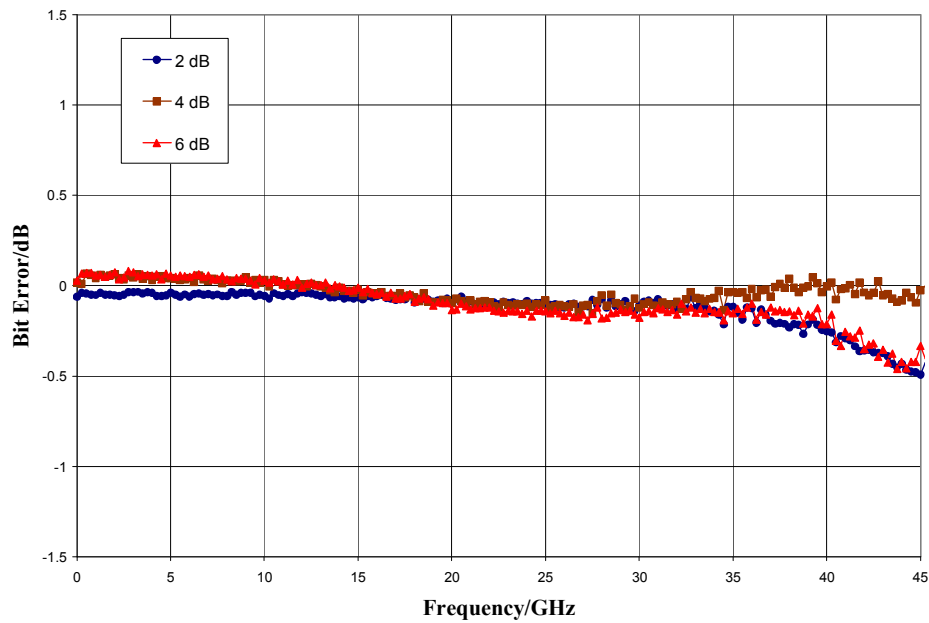

Relative Phase versus Frequency, $T_A = 25\text{ }^\circ\text{C}$

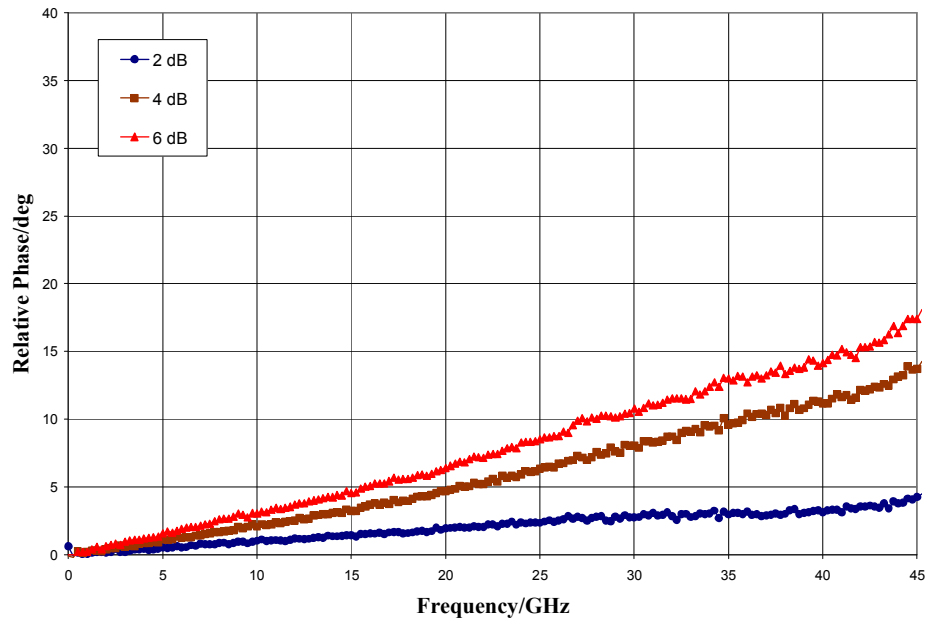

ver 1.1 0718

Typical Performance

Input Power for 0.1 dB Compression (insertion loss state)

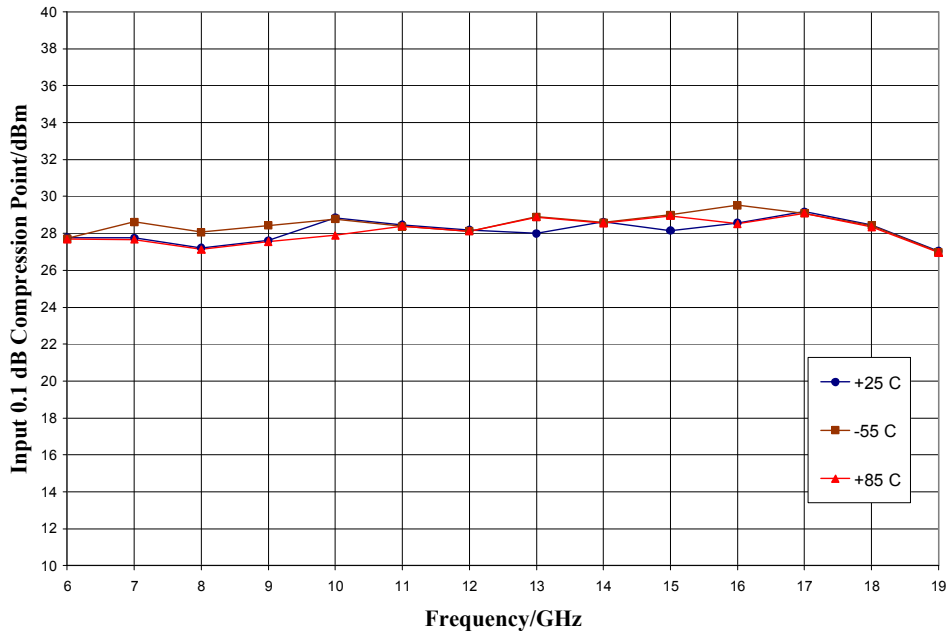

Input IP3 versus Temperature (insertion loss state)

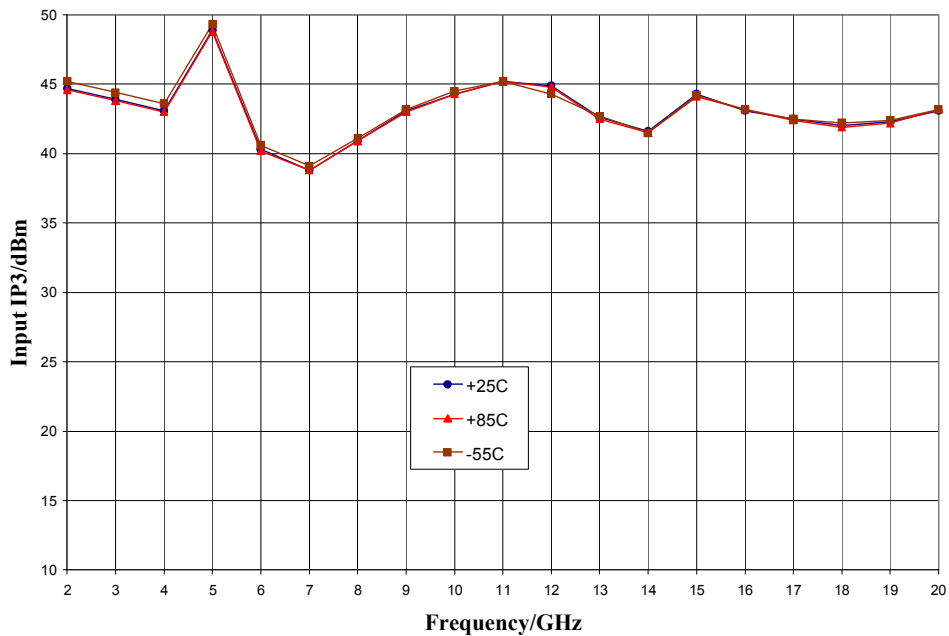

ver 1.1 0718

Mechanical Information

Die Outline (all dimensions in microns)

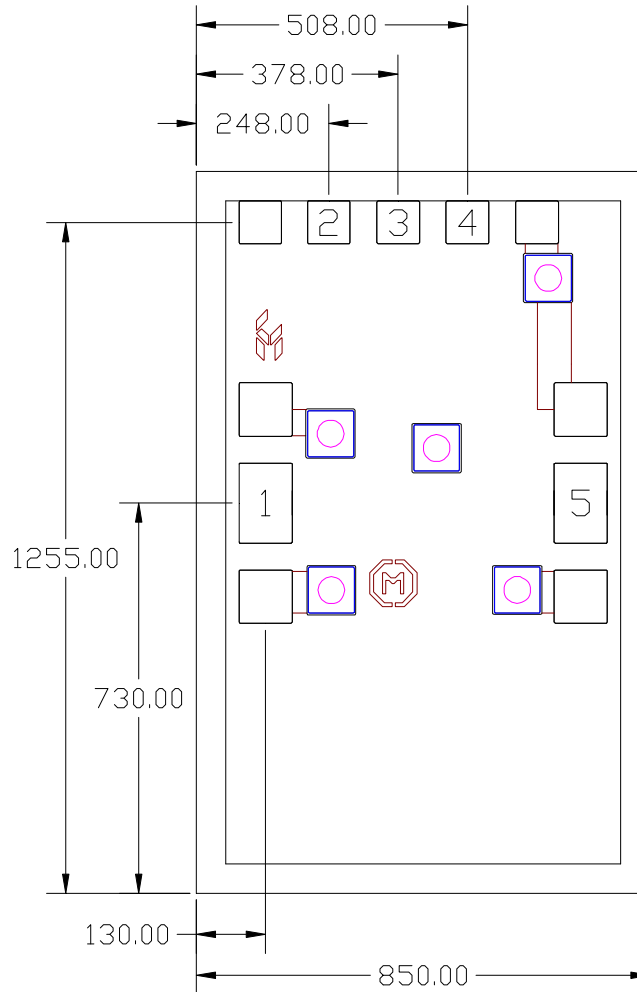

Notes:



1. No connection required for unlabeled pads
2. Backside is RF and DC ground
3. Backside and bond pad metal: Gold
4. Die is 100 microns thick
5. DC bond pads (2, 3, 4,) are 80 x 80 microns square
6. RF bond pads (1, 5) are 100 x 150 microns

Pad Description

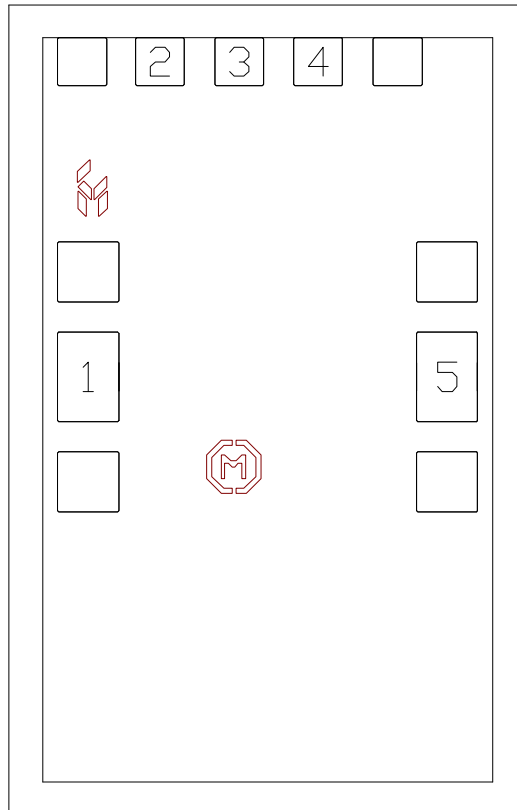
Pad Diagram

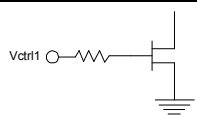

Functional Description

| Pad | Function | Description | Schematic |
|----------|----------|--|---|
| 1, 5 | RF1, RF2 | 50 ohm matched | |
| 2 | Vee | Negative bias -5V | |
| 3, 4 | P0, P1 | Bit control voltages, see truth table for values |  |
| Backside | Ground | Connect to RF / DC ground |  |

ver 1.1 0718

Applications Information

Assembly Guidelines

The backside of the CMD281 is RF ground. Die attach should be accomplished with electrically and thermally conductive epoxy only. Eutectic attach is not recommended. Standard assembly procedures should be followed for high frequency devices. The top surface of the semiconductor should be made planar to the adjacent RF transmission lines, and the RF decoupling capacitors placed in close proximity to the DC connections on chip.

RF connections should be made as short as possible to reduce the inductive effect of the bond wire. Use of a 0.8 mil thermosonic wedge bonding is highly recommended as the loop height will be minimized. The RF input and output require a single bond wire as shown.

The semiconductor is 100 um thick and should be handled by the sides of the die or with a custom collet. Do not make contact directly with the die surface as this will damage the monolithic circuitry. Handle with care.

Assembly Diagram

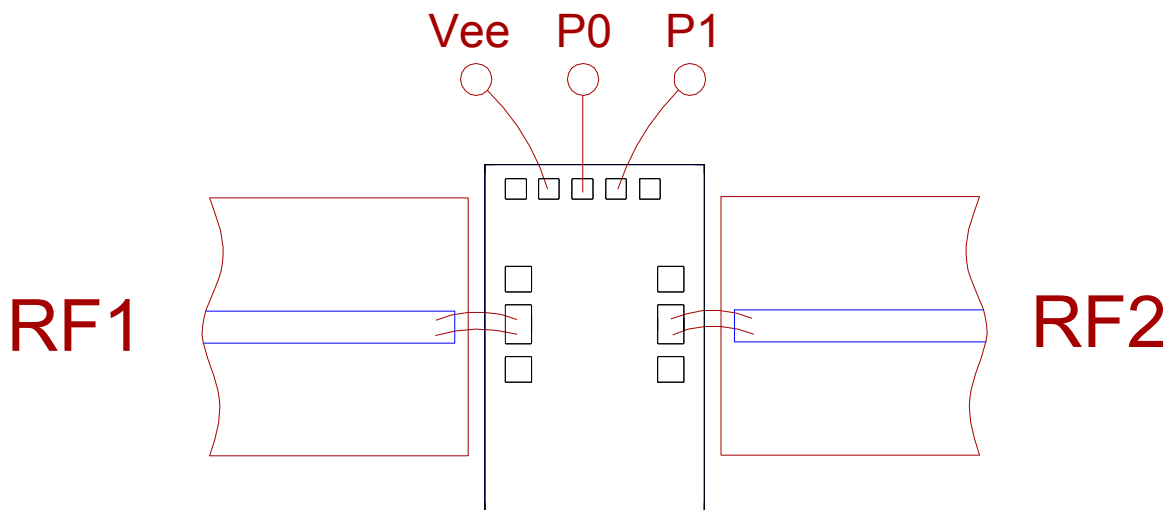

Biasing and Operation

The CMD281 has two control lines and a Vee bias port. The CMD281 will not operate unless Vee is applied to the MMIC.

GaAs MMIC devices are susceptible to damage from Electrostatic Discharge. Proper precautions should be observed during handling, assembly and test.

Please note, all information contained in this data sheet is subject to change without notice.

ver 1.1 0718