

Features

- ▶ Ultra wideband performance
- ▶ Low phase noise
- ▶ Low current consumption
- ▶ Pb-free RoHs compliant 4x4 mm QFN package

Description

The CMD274P4 is a wideband GaAs MMIC low phase noise amplifier housed in a leadless surface mount package that is ideally suited for military, space and communications systems. At 10 GHz the device delivers 17 dB of gain, a saturated output power of +22 dBm and a noise figure of 3.2 dB. Also with an input signal of 10 GHz the amplifier provides low phase noise performance of -165 dBc/Hz at 10 kHz offset. The CMD274P4 is a 50 ohm matched design which eliminates the need for external DC blocks and RF port matching.

Functional Block Diagram

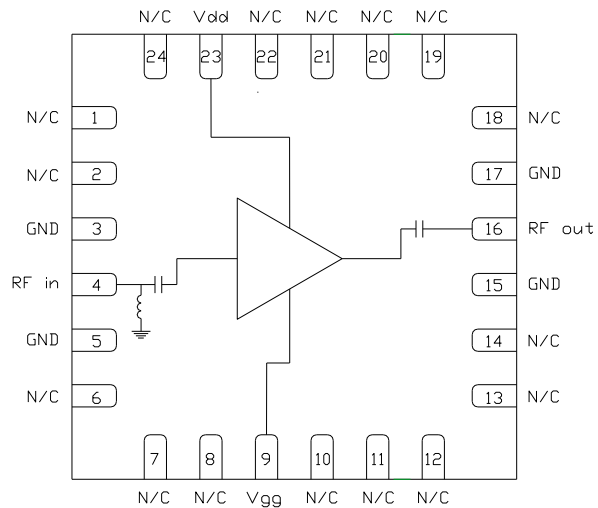

Electrical Performance – $V_{dd} = 5.0\text{ V}$, $V_{gg} = 3.0\text{ V}$, $T_A = 25\text{ }^\circ\text{C}$, $F = 10\text{ GHz}$

Parameter	Min	Typ	Max	Units
Frequency Range	2 – 20			GHz
Gain		17		dB
Input Return Loss		12		dB
Output Return Loss		13		dB
Noise Figure		3.2		dB
Output P1dB		19		dBm
Saturated Output Power		22		dBm
Phase Noise @ 10 kHz Offset		-165		dBc/Hz
Supply Current		86		mA

ver 1.1 0118



CMD274P4

2-20 GHz Low Phase Noise Amplifier

Specifications

Absolute Maximum Ratings

Parameter	Rating
Drain Voltage, V _{dd}	7.5 V
Gate Voltage, V _{gg}	3.5 V
RF Input Power	+10 dBm
Channel Temperature, T _{ch}	150 °C
Power Dissipation, P _{diss}	495 mW
Thermal Resistance, Θ_{JC}	131 °C/W
Operating Temperature	-40 to 85 °C
Storage Temperature	-55 to 150 °C

Exceeding any one or combination of the maximum ratings may cause permanent damage to the device.

Recommended Operating Conditions

Parameter	Min	Typ	Max	Units
V _{dd}	4.0	5.0	7.0	V
I _{dd}		86		mA
V _{gg}	2.0	3.0	3.3	V
I _{gg}		5		mA

Electrical performance is measured at specific test conditions. Electrical specifications are not guaranteed over all recommended operating conditions.

Electrical Specifications – V_{dd} = 5.0 V, V_{gg} = 3.0 V, T_A = 25 °C

Parameter	Min	Typ	Max	Min	Typ	Max	Units
Frequency Range	2 – 10			10 – 20			GHz
Gain	14	17.5		14	17.5		dB
Noise Figure		6			3.5		dB
Input Return Loss		12			12		dB
Output Return Loss		13			12		dB
Output P1dB	16.5	19.5		13	17		dBm
Saturated Output Power		22			21		dBm
Output IP3		30.5			29.5		dBm
Phase Noise @ 10 kHz Offset		-165			-165		dBc/Hz
Supply Current	60	86	115	60	86	115	mA

ver 1.1 0118

Typical Performance

Broadband Performance, $V_{dd} = 5.0$ V, $V_{gg} = 3.0$ V, $I_{dd} = 74$ mA, $T_A = 25$ °C

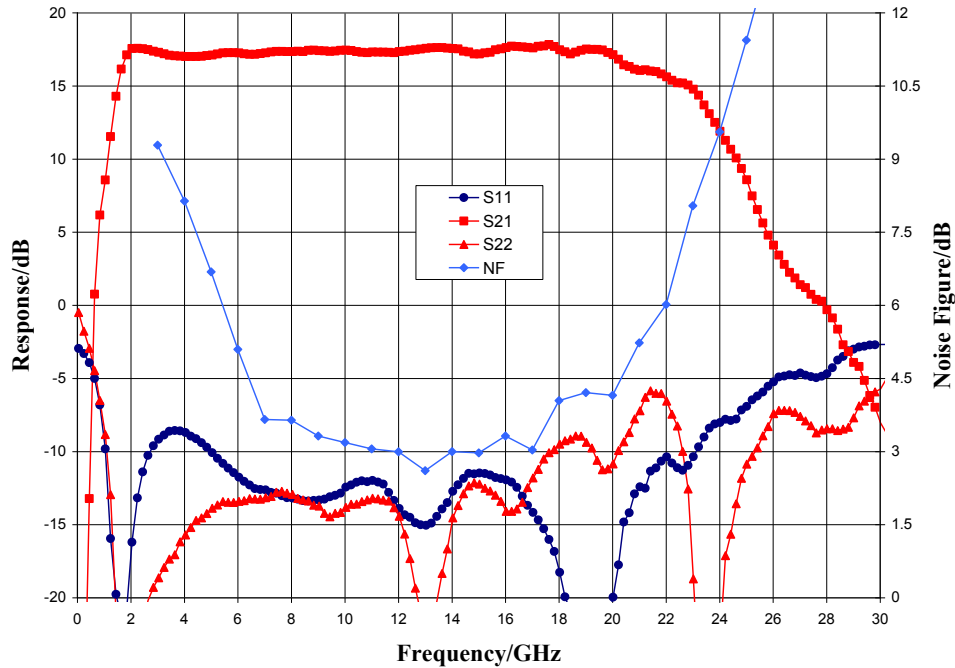

Narrow-band Performance, $V_{dd} = 5.0$ V, $V_{gg} = 3.0$ V, $I_{dd} = 74$ mA, $T_A = 25$ °C

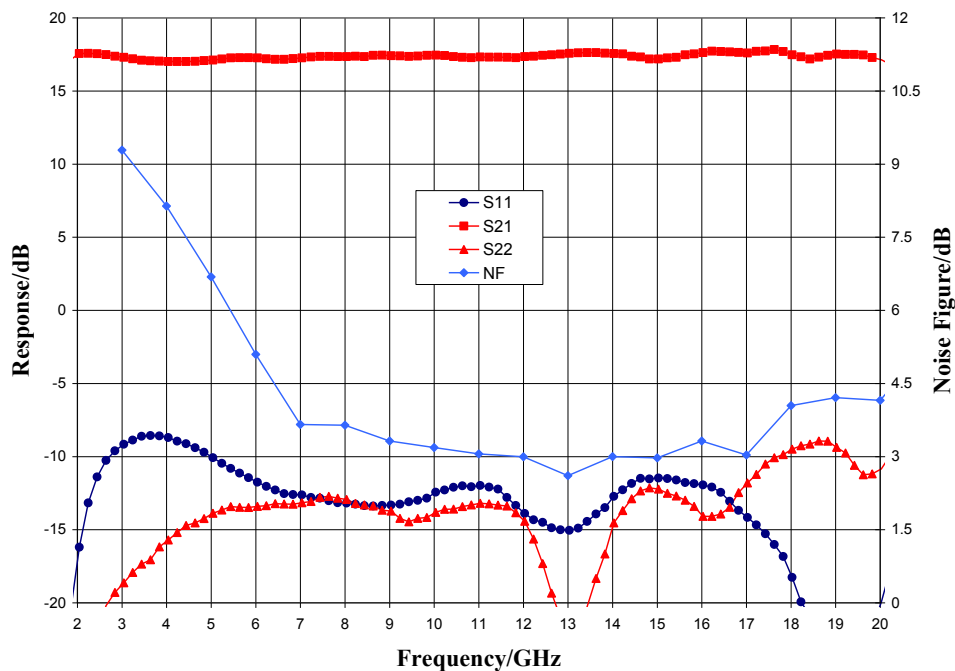

ver 1.1 0118

Typical Performance

Additive Phase Noise @ Psat, V_{dd} = 5.0 V, V_{gg} = 3.0 V, T_A = 25 °C

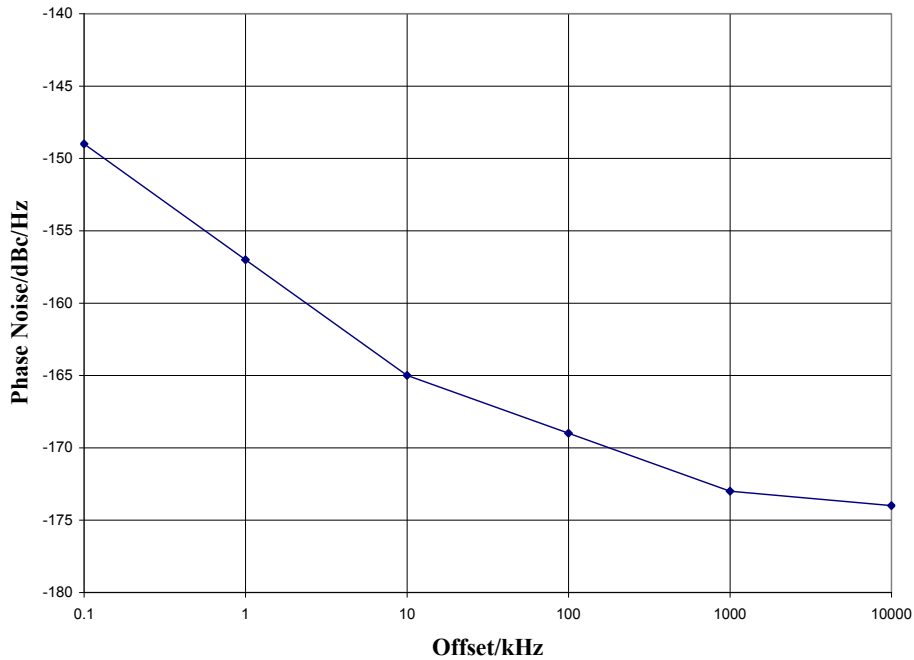

Gain vs. Temperature, V_{dd} = 5.0 V, V_{gg} = 3.0 V

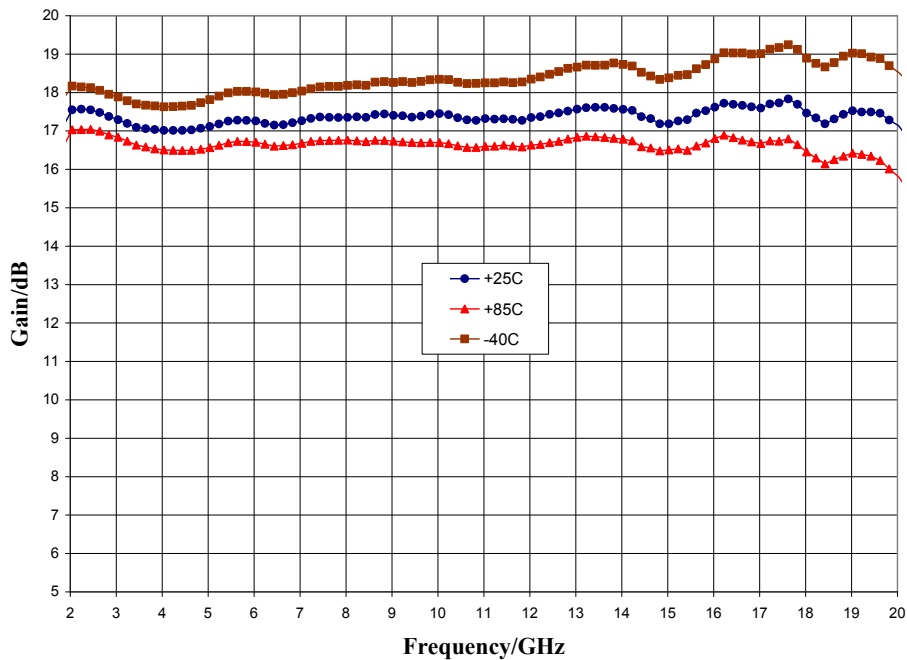

ver 1.1 0118

Typical Performance

P1dB vs. Temperature, $V_{dd} = 5.0\text{ V}$, $V_{gg} = 3.0\text{ V}$

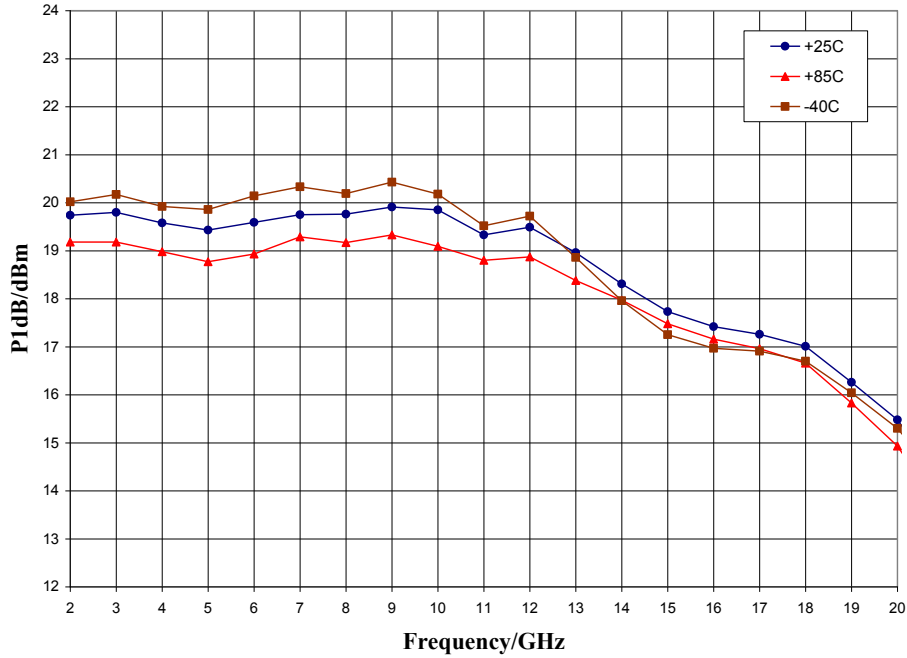

Psat vs. Temperature, $V_{dd} = 5.0\text{ V}$, $V_{gg} = 3.0\text{ V}$

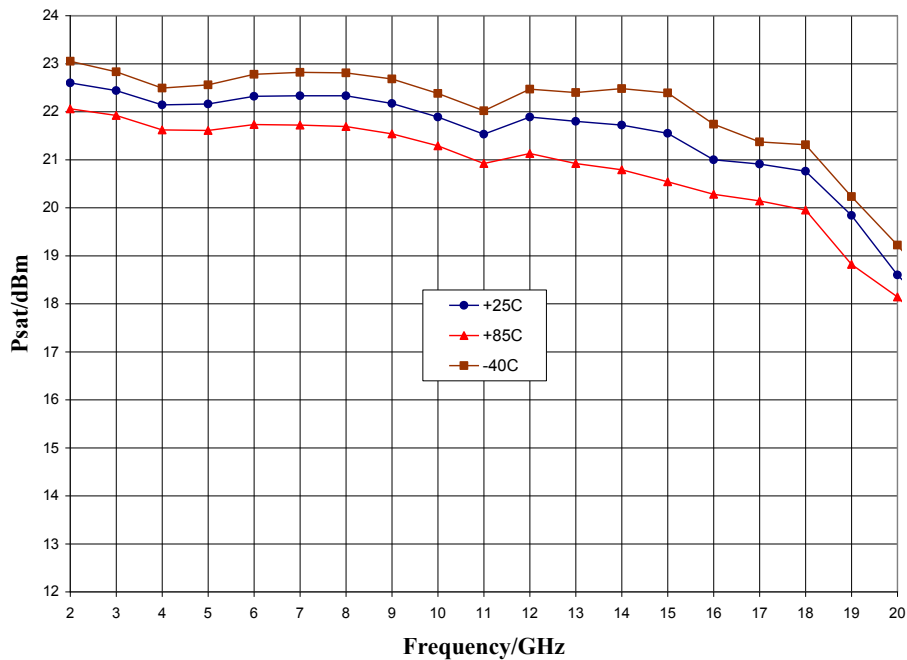

ver 1.1 0118

Typical Performance

Output IP3 vs. Temperature, $V_{dd} = 5.0\text{ V}$, $V_{gg} = 3.0\text{ V}$

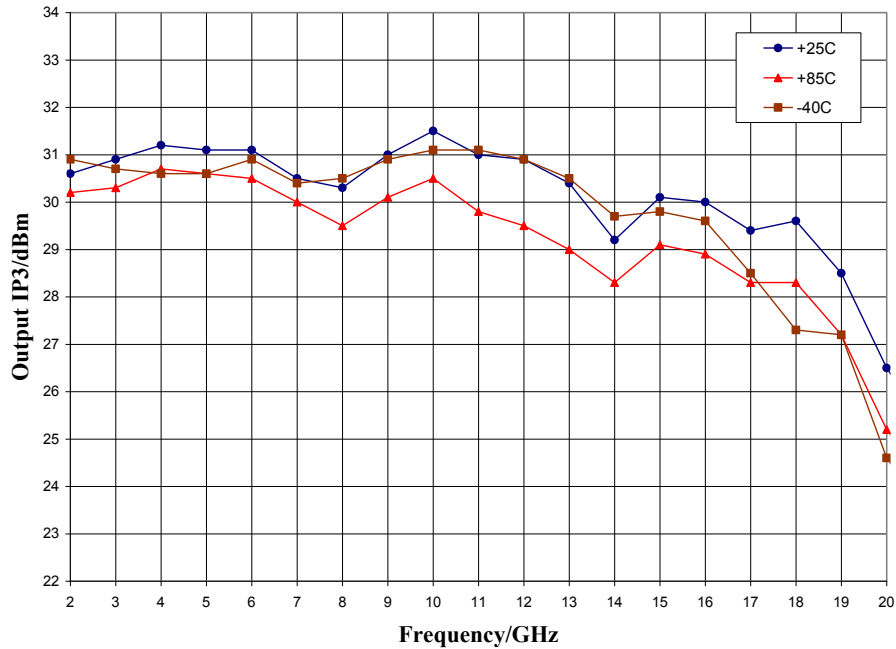

Noise Figure vs. Temperature, $V_{dd} = 5.0\text{ V}$, $V_{gg} = 3.0\text{ V}$

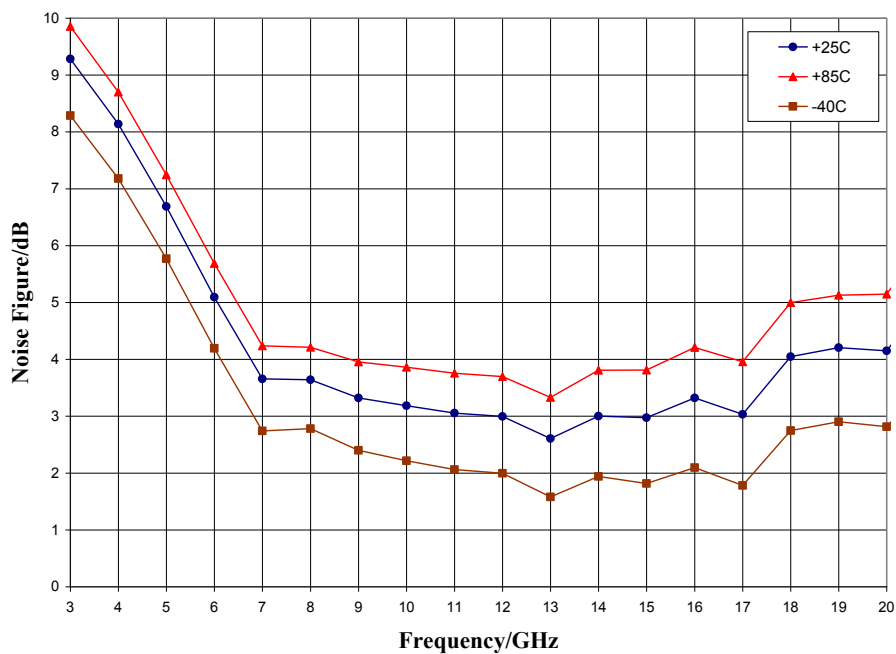

Mechanical Information

Package Information and Dimensions

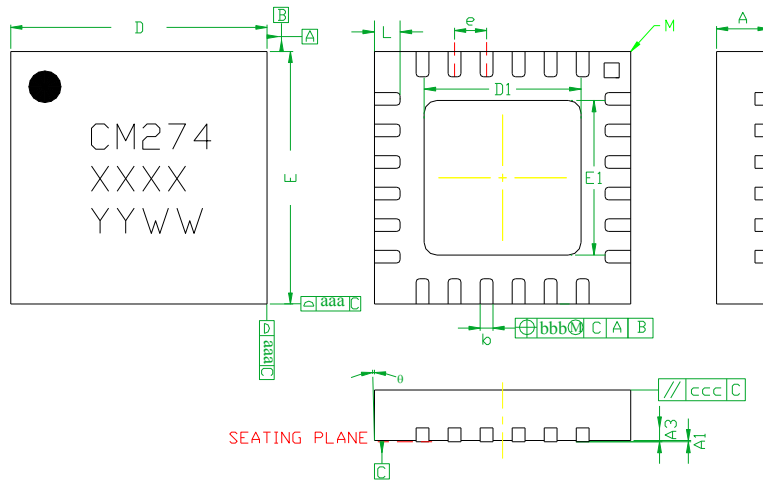

SYMBOLS	DIMENSIONS IN MILLIMETERS		
	MIN	NOM	MAX
A	0.80	0.90	1.00
A1	0	0.02	0.05
A3	---	0.25REF.	---
b	0.18	0.23	0.30
D	3.85	4.00	4.15
D1	2.40	2.50	2.60
E	3.85	4.00	4.15
E1	2.40	2.50	2.60
e	---	0.50BSC	---
L	0.30	0.40	0.50
theta	0	---	12
aaa	---	0.25	---
bbb	---	0.10	---
ccc	---	0.10	---
M	---	---	0.05

NOTES:

1. DIMENSIONS ARE IN MILLIMETERS
2. RoHS COMPLIANT MOLD COMPOUND
3. LEADFRAME MATERIAL: COPPER ALLOY
4. LEAD FINISH: 100% MATTE Sn
5. INDICATED DIMENSION/TOLERANCE APPLIES TO LEADS AND EXPOSED PAD

Recommended PCB Land Pattern

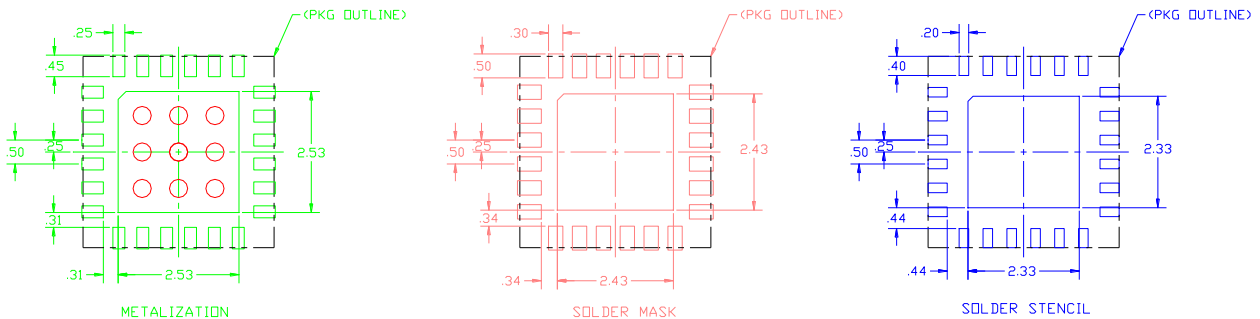

Pin Description

Pin Diagram

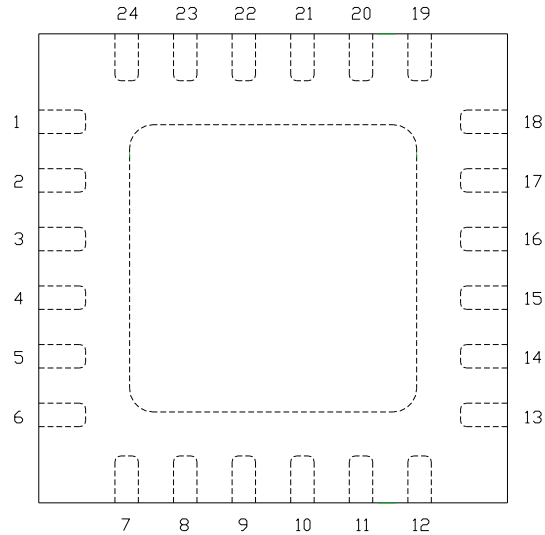

Functional Description

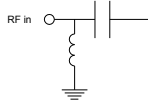
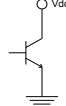
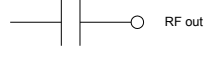
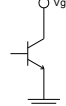
Pad	Function	Description	Schematic
1, 2, 6-8, 10-14, 18-22, 24	N/C	No connection required. These pins may be connected to RF/DC ground.	
3, 5, 15, 17 and die paddle	Ground	Connect to RF / DC ground	
4	RF in	DC coupled and 50 ohm matched	
23	Vdd	Power supply voltage Decoupling and bypass caps required	
16	RF out	DC blocked and 50 ohm matched	
9	Vgg	Power supply voltage Decoupling and bypass caps required	

ver 1.1 0118

Applications Information

Application Circuit

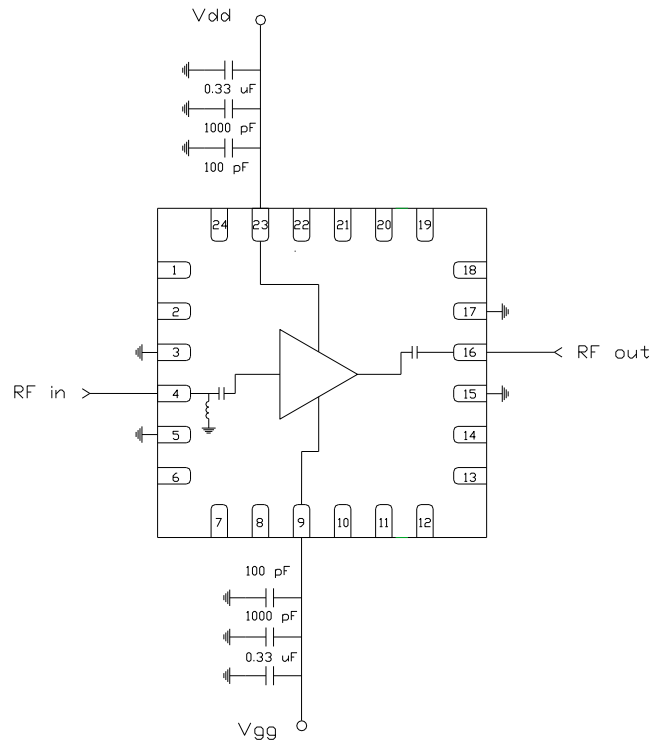

Biasing and Operation

The CMD274P4 is biased with a positive drain supply and positive gate supply. Performance is optimized when the drain voltage is set to +5.0 V. The recommended gate voltage is +3.0 V. The preferred biasing procedure is as follows:

Turn ON procedure:

Apply the drain voltage V_{dd} and set it to +5V then apply gate voltage V_{gg} and set it to +3V.

Turn OFF procedure:

Turn off the gate voltage V_{gg} and then turn off the drain voltage V_{dd} .

The preferred biasing procedure has been proven to be robust, and should be used whenever possible. However, the CMD274P4 does allow for simultaneous biasing (applying V_{dd} and V_{gg} at the same time), and the use of a single voltage supply.

Refer to Application Note 103: Amplifier Biasing Techniques for instructions on how to implement a single supply biasing scheme.

For either approach, RF power can be applied at any time.

ver 1.1 0118

Applications Information

Evaluation Board

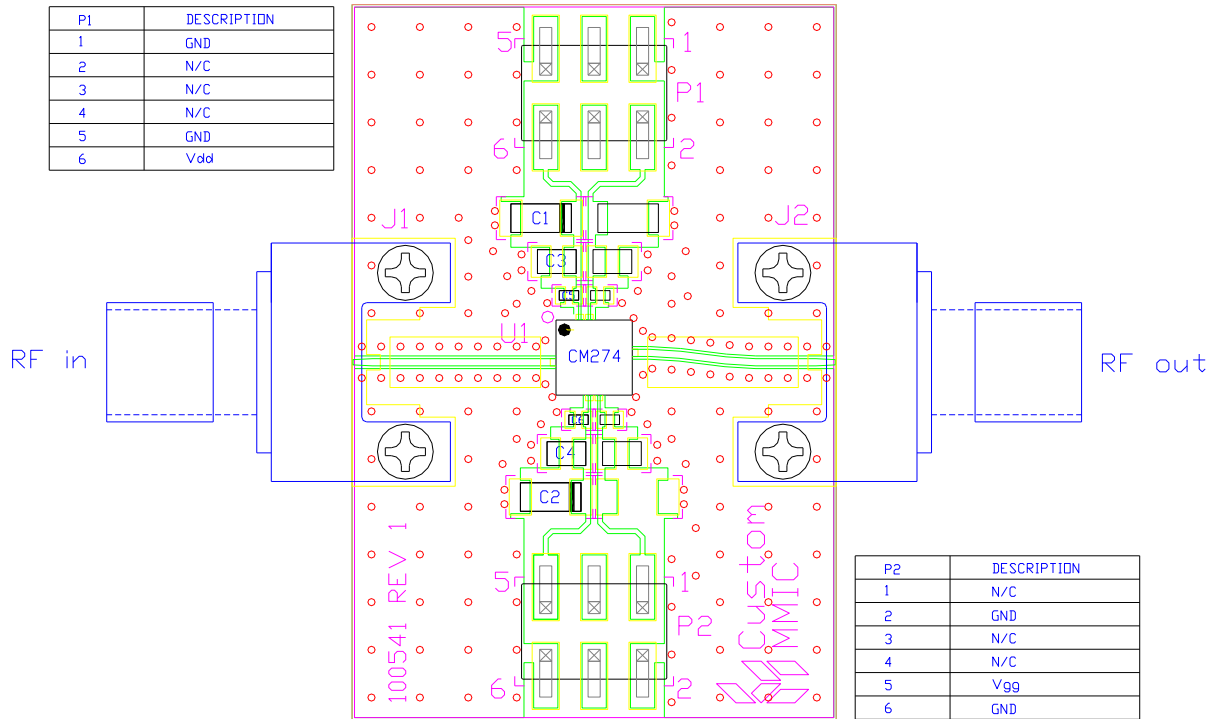

Bill of Material

Designator	Value	Description
J1, J2		SMA End Launch Connector
P1, P2		6 Pin DC Header
C1, C2	0.33 μ F	Capacitor, Tantalum
C3, C4	1000 pF	Capacitor, 0603
C5, C6	100 pF	Capacitor, 0402
U1		CMD274P4 Driver Amplifier
PCB		100541 Evaluation PCB

GaAs MMIC devices are susceptible to damage from Electrostatic Discharge. Proper precautions should be observed during handling, assembly and test.

Please note, all information contained in this data sheet is subject to change without notice.

ver 1.1 0118