

### Features

- ▶ Ultra wideband performance
- ▶ Low phase noise
- ▶ Low current consumption
- ▶ Small die size

### Description

The CMD274 is a wideband GaAs MMIC low phase noise amplifier die that is ideally suited for military, space and communications systems. At 10 GHz the device delivers 17 dB of gain, a saturated output power of +22 dBm and a noise figure of 3.2 dB. Also with an input signal of 10 GHz the amplifier provides low phase noise performance of -165 dBc/Hz at 10 kHz offset. The CMD274 is a 50 ohm matched design which eliminates the need for external DC blocks and RF port matching.

### Functional Block Diagram

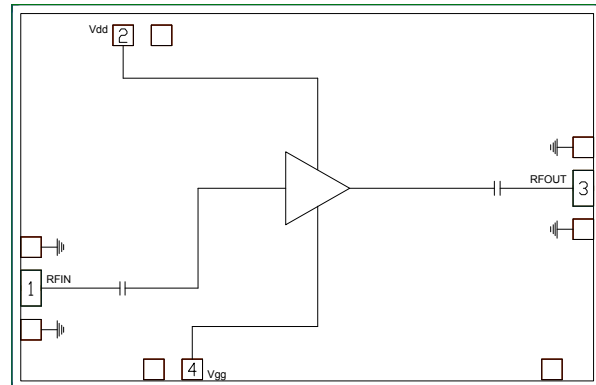

### Electrical Performance – $V_{dd} = 5.0 \text{ V}$ , $V_{gg} = 3.0 \text{ V}$ , $T_A = 25 \text{ }^\circ\text{C}$ , $F = 10 \text{ GHz}$

Parameter	Min	Typ	Max	Units
Frequency Range	2 – 20			GHz
Gain		17		dB
Input Return Loss		12		dB
Output Return Loss		13		dB
Noise Figure		3.2		dB
Output P1dB		19		dBm
Saturated Output Power		22		dBm
Phase Noise @ 10 kHz Offset		-165		dBc/Hz
Supply Current		86		mA

ver 1.0 0918

### Specifications

#### Absolute Maximum Ratings

Parameter	Rating
Drain Voltage, V <sub>dd</sub>	7.5 V
Gate Voltage, V <sub>gg</sub>	3.5 V
RF Input Power	+10 dBm
Channel Temperature, T <sub>ch</sub>	150 °C
Power Dissipation, P <sub>diss</sub>	495 mW
Thermal Resistance, $\Theta_{JC}$	131 °C/W
Operating Temperature	-55 to 85 °C
Storage Temperature	-55 to 150 °C

Exceeding any one or combination of the maximum ratings may cause permanent damage to the device.

#### Recommended Operating Conditions

Parameter	Min	Typ	Max	Units
V <sub>dd</sub>	4.0	5.0	7.0	V
I <sub>dd</sub>		86		mA
V <sub>gg</sub>	2.0	3.0	3.3	V
I <sub>gg</sub>		5		mA

Electrical performance is measured at specific test conditions. Electrical specifications are not guaranteed over all recommended operating conditions.

#### Electrical Specifications – V<sub>dd</sub> = 5.0 V, V<sub>gg</sub> = 3.0 V, T<sub>A</sub> = 25 °C

Parameter	Min	Typ	Max	Min	Typ	Max	Units
Frequency Range	2 – 10			10 – 20			GHz
Gain	14	17.5		14	17.5		dB
Noise Figure		6			3.5		dB
Input Return Loss		12			12		dB
Output Return Loss		13			12		dB
Output P1dB	16.5	19.5		13	17		dBm
Saturated Output Power		22			21		dBm
Output IP3		30.5			29.5		dBm
Phase Noise @ 10 kHz Offset		-165			-165		dBc/Hz
Supply Current	60	86	115	60	86	115	mA

ver 1.0 0918

### Typical Performance

**Broadband Performance,  $V_{dd} = 5.0\text{ V}$ ,  $V_{gg} = 3.0\text{ V}$ ,  $I_{dd} = 74\text{ mA}$ ,  $T_A = 25\text{ }^\circ\text{C}$**

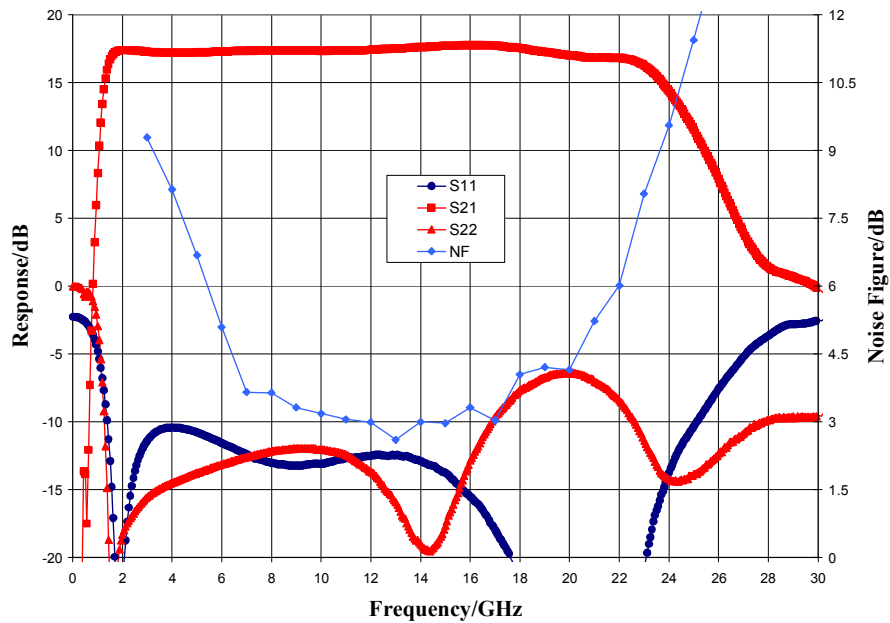

**Narrow-band Performance,  $V_{dd} = 5.0\text{ V}$ ,  $V_{gg} = 3.0\text{ V}$ ,  $I_{dd} = 74\text{ mA}$ ,  $T_A = 25\text{ }^\circ\text{C}$**

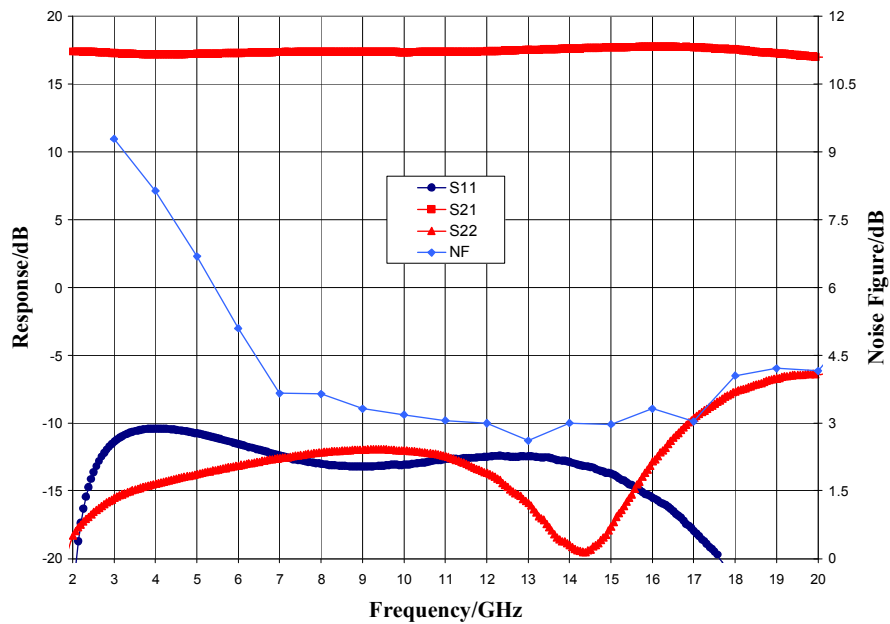

ver 1.0 0918

### Typical Performance

Additive Phase Noise @  $P_{sat}$ ,  $V_{dd} = 5.0\text{ V}$ ,  $V_{gg} = 3.0\text{ V}$ ,  $T_A = 25\text{ }^\circ\text{C}$

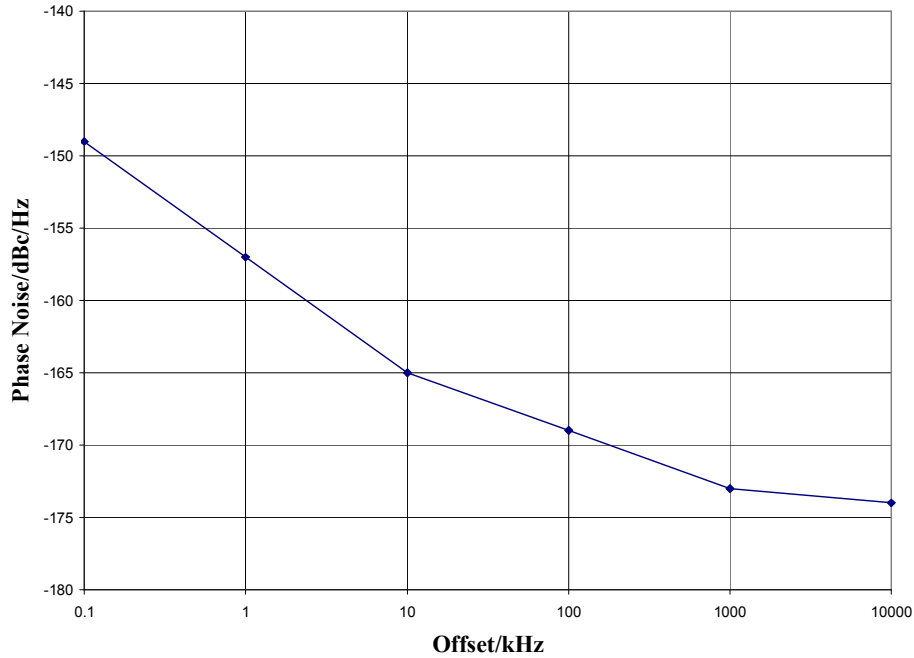

Gain vs. Temperature,  $V_{dd} = 5.0\text{ V}$ ,  $V_{gg} = 3.0\text{ V}$

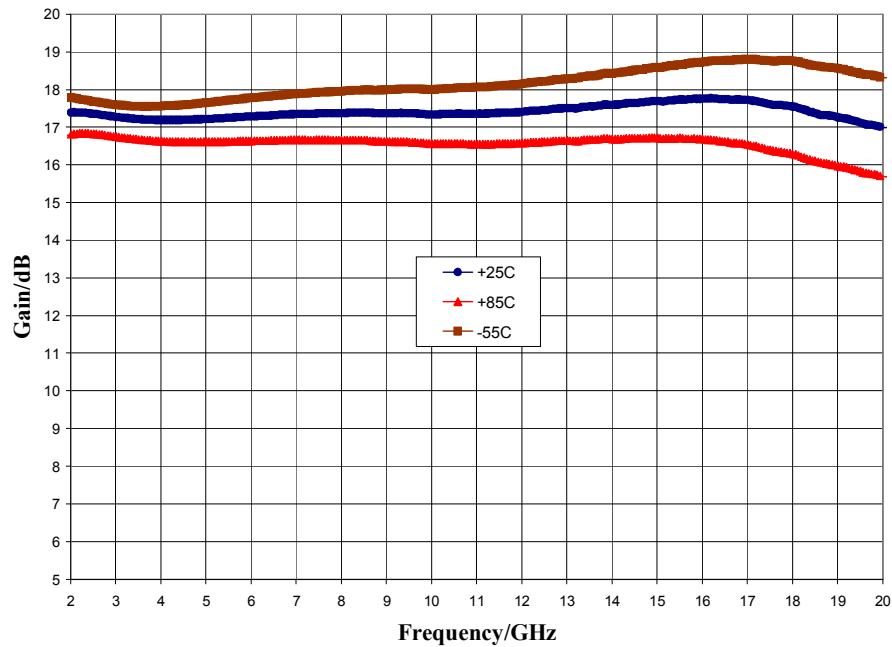

ver 1.0 0918

### Typical Performance

**P1dB vs. Temperature,  $V_{dd} = 5.0\text{ V}$ ,  $V_{gg} = 3.0\text{ V}$**

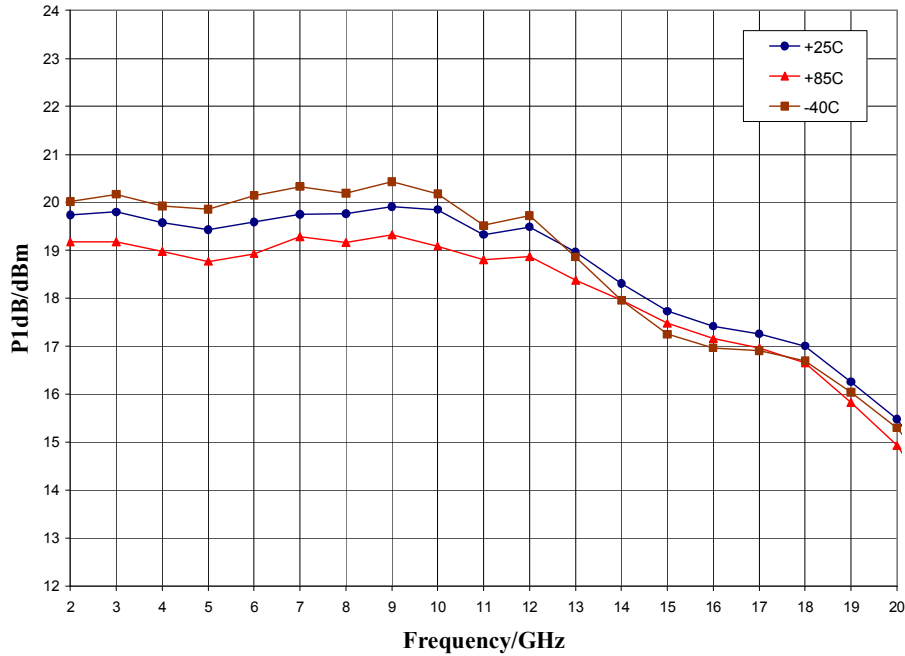

**Psat vs. Temperature,  $V_{dd} = 5.0\text{ V}$ ,  $V_{gg} = 3.0\text{ V}$**

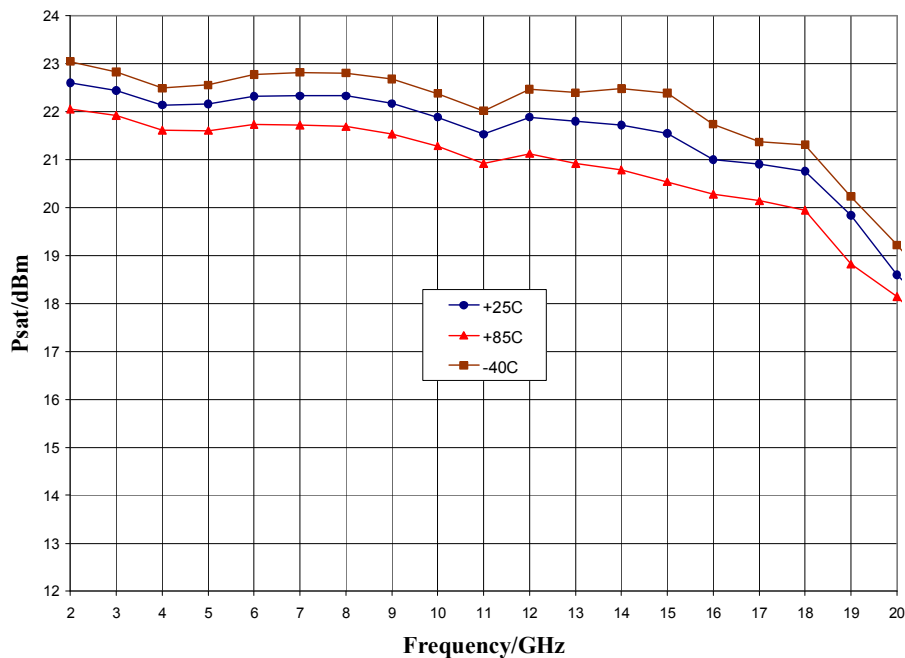

### Typical Performance

**Output IP3 vs. Temperature,  $V_{dd} = 5.0\text{ V}$ ,  $V_{gg} = 3.0\text{ V}$**

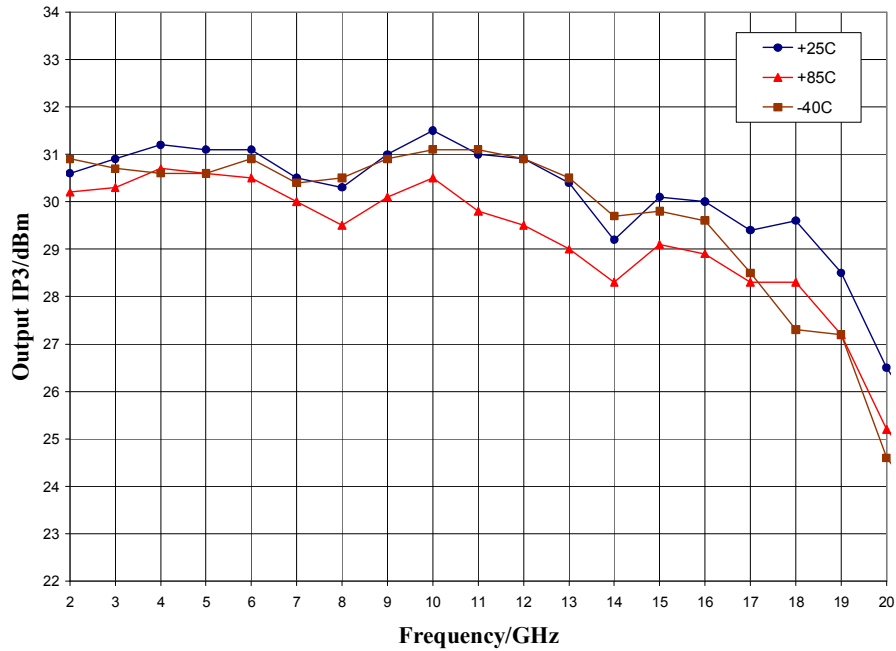

**Noise Figure vs. Temperature,  $V_{dd} = 5.0\text{ V}$ ,  $V_{gg} = 3.0\text{ V}$**

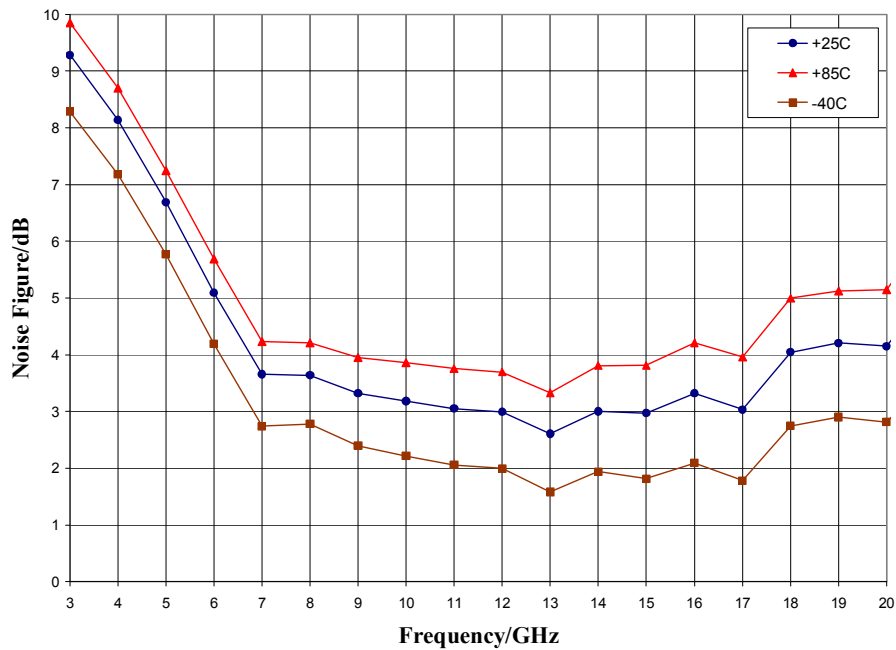

### Mechanical Information

#### Die Outline (all dimensions in microns)

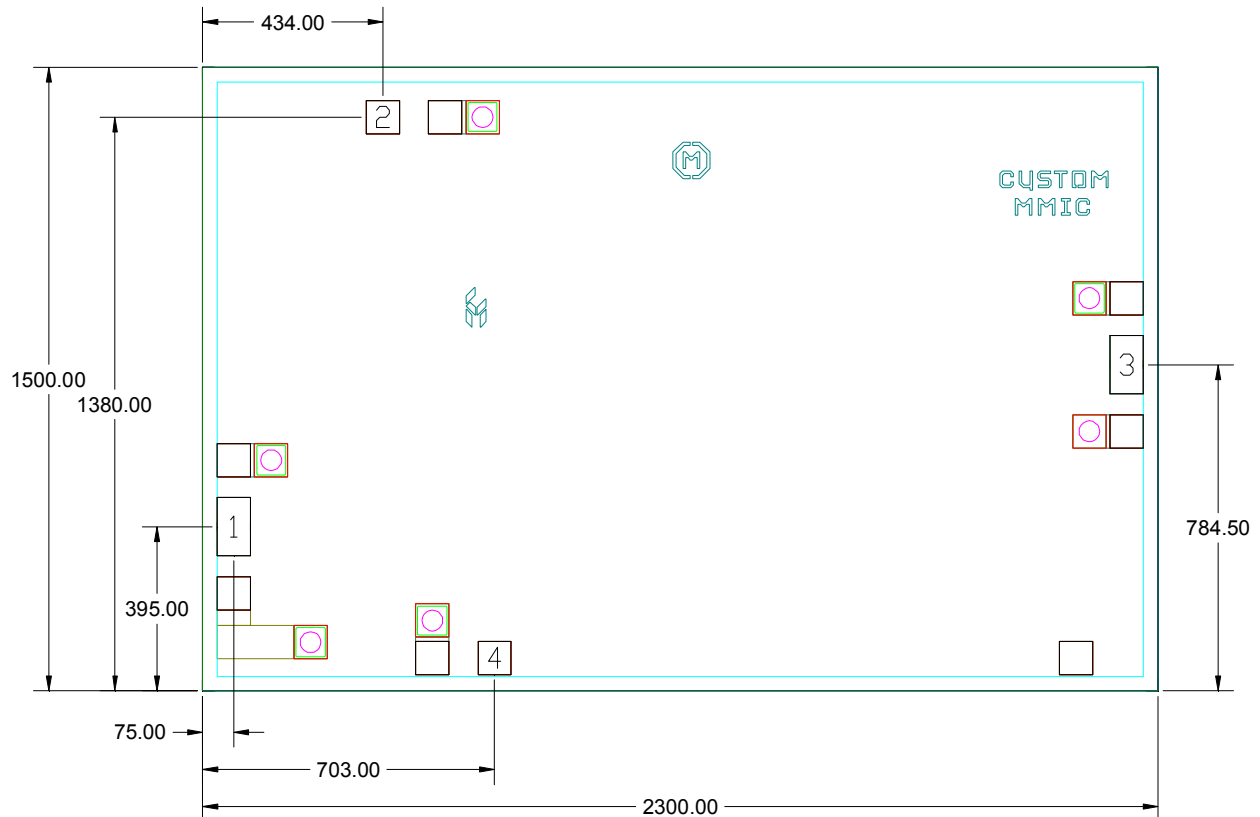

#### Notes:



1. No connection required for unlabeled pads
2. Backside is RF and DC ground
3. Backside and bond pad metal: Gold
4. Die is 100 microns thick
5. DC bond pads (2, 4) are 80 x 80 microns
6. RF bond pads (1, 3) are 80 x 140 microns

### Pad Description

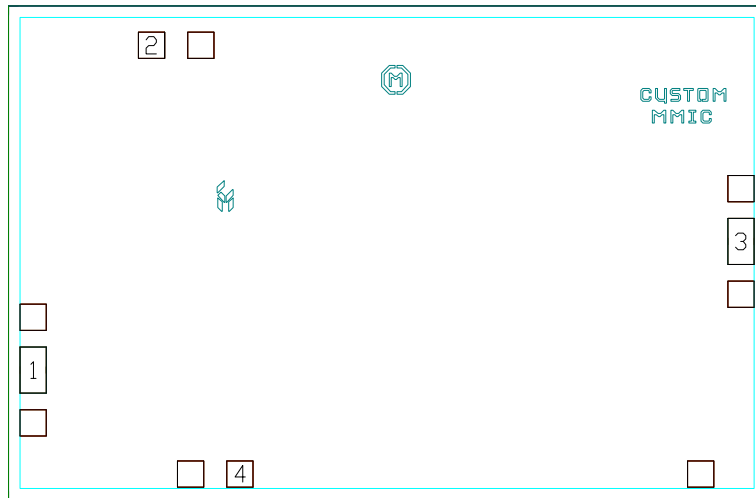
#### Pad Diagram

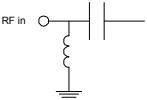
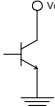
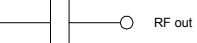
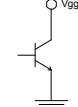

#### Functional Description

Pad	Function	Description	Schematic
1	RF in	DC coupled and 50 ohm matched	
2	Vdd	Power supply voltage Decoupling and bypass caps required	
3	RF out	DC blocked and 50 ohm matched	
4	Vgg	Power supply voltage Decoupling and bypass caps required	
Backside	Ground	Connect to RF/DC ground	

ver 1.0 0918



### Applications Information

#### Assembly Guidelines

The backside of the CMD274 is RF ground. Die attach should be accomplished with electrically and thermally conductive epoxy only. Eutectic attach is not recommended. Standard assembly procedures should be followed for high frequency devices. The top surface of the semiconductor should be made planar to the adjacent RF transmission lines, and the RF decoupling capacitors placed in close proximity to the DC connections on chip.

RF connections should be made as short as possible to reduce the inductive effect of the bond wire. Use of a 0.8 mil thermosonic wedge bonding is highly recommended as the loop height will be minimized. The RF input and output require a double bond wire as shown.

The semiconductor is 100 um thick and should be handled by the sides of the die or with a custom collet. Do not make contact directly with the die surface as this will damage the monolithic circuitry. Handle with care.

#### Assembly Diagram

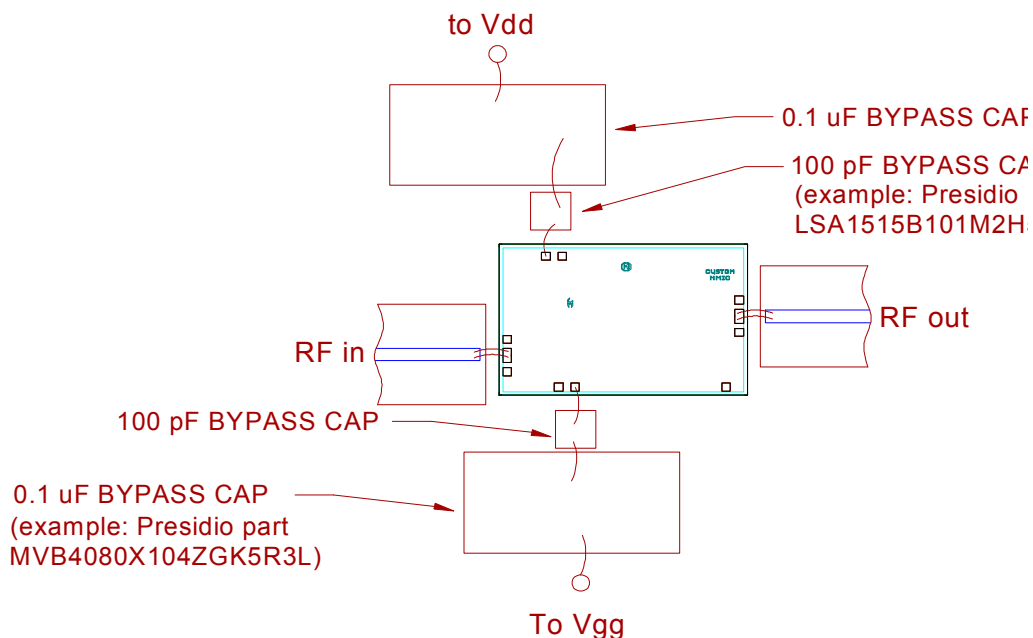

**GaAs MMIC devices are susceptible to damage from Electrostatic Discharge. Proper precautions should be observed during handling, assembly and test.**

ver 1.0 0918

### Applications Information

#### Application Circuit

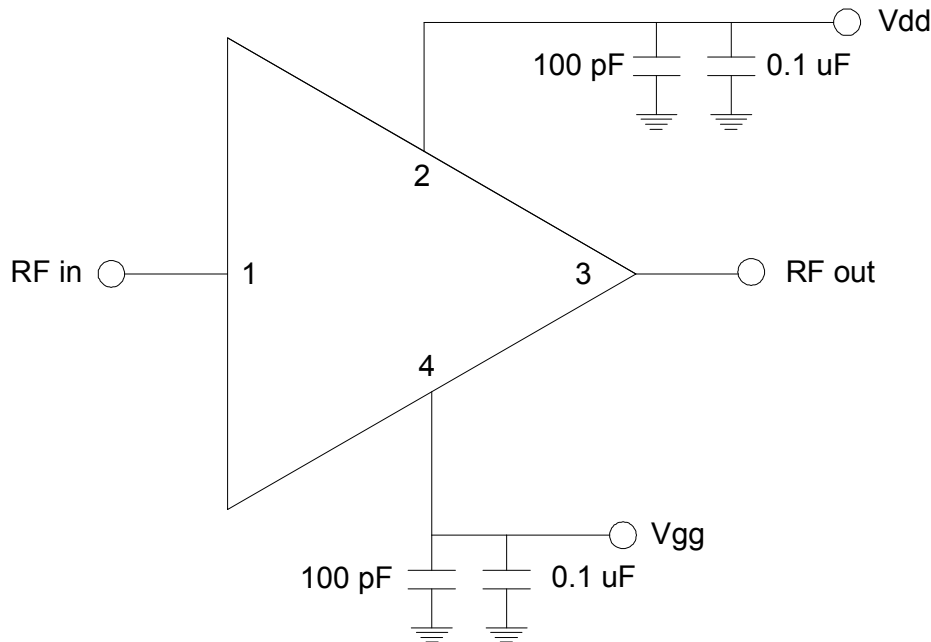

#### Biasing and Operation

The CMD274 is biased with a positive drain supply and positive gate supply. Performance is optimized when the drain voltage is set to +5.0 V. The recommended gate voltage is +3.0 V. The preferred biasing procedure is as follows:

Turn ON procedure:

Apply the drain voltage Vdd and set it to +5V then apply gate voltage Vgg and set it to +3V.

Turn OFF procedure:

Turn off the gate voltage Vgg and then turn off the drain voltage Vdd.

The preferred biasing procedure has been proven to be robust, and should be used whenever possible. However, the CMD274 does allow for simultaneous biasing (applying Vdd and Vgg at the same time), and the use of a single voltage supply.

Refer to Application Note 103: Amplifier Biasing Techniques for instructions on how to implement a single supply biasing scheme.

For either approach, RF power can be applied at any time.

*Please note, all information contained in this data sheet is subject to change without notice.*

ver 1.0 0918