

Features

- ▶ High Power
- ▶ High linearity
- ▶ Excellent efficiency
- ▶ Small die size

Description

The CMD262 is a 5 W GaN MMIC power amplifier die ideally suited for Ka-band communications systems where high power and high linearity are needed. The device delivers greater than 26 dB of gain with a corresponding output 1 dB compression point of +37 dBm and a saturated output power of +38 dBm at 29% power added efficiency. The CMD262 is a 50 ohm matched design eliminating the need for external DC blocks and RF port matching. The CMD262 offers full passivation for increased reliability and moisture protection.

Functional Block Diagram

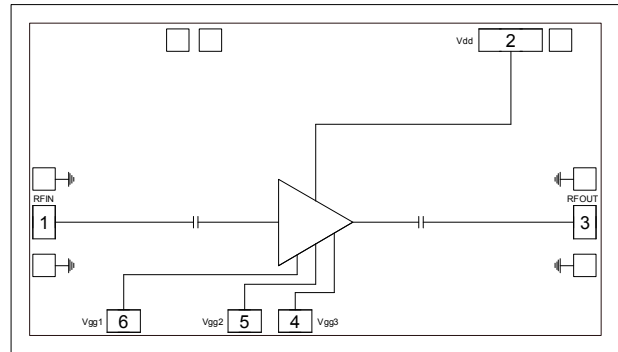

Electrical Performance – $V_{dd} = 28\text{ V}$, $V_{gg1} = V_{gg2} = V_{gg3} = -4\text{ V}$, $T_A = 25\text{ }^\circ\text{C}$, $F = 27\text{ GHz}$

Parameter	Min	Typ	Max	Units
Frequency Range	26 – 28			GHz
Gain		26		dB
Output P1dB		37		dBm
Output Psat		38		dBm
Input Return Loss		10		dB
Output Return Loss		15		dB
Supply Current		400		mA

Specifications

Absolute Maximum Ratings

Parameter	Rating
Drain Voltage, Vdd	32 V
Gate Voltage, Vgg1, 2, 3	-10 V
RF Input Power	+25 dBm
Channel Temperature, Tch	175 °C
Power Dissipation, P _{diss}	18.2 W
Thermal Resistance, Θ_{JC}	4.93 °C/W
Operating Temperature	-55 to 85 °C
Storage Temperature	-55 to 150 °C

Exceeding any one or combination of the maximum ratings may cause permanent damage to the device.

Recommended Operating Conditions

Parameter	Min	Typ	Max	Units
Vdd	20	28	30	V
I _{dd}		400		mA
V _{gg1, 2, 3}	-5	-4	-3	V

Electrical performance is measured at specific test conditions. Electrical specifications are not guaranteed over all recommended operating conditions.

Electrical Specifications – V = 28 V, V_{gg1} = V_{gg2} = V_{gg3} = -4 V, T_A = 25 °C

Parameter	Min	Typ	Max	Units
Frequency Range	26 – 28			GHz
Gain	22	26		dB
Input Return Loss		13		dB
Output Return Loss		10		dB
Output P1dB	34	37		dBm
Psat		38		dBm
Power Added Efficiency		28		%
Supply Current	280	400	520	mA

Typical Performance

Broadband Performance, $V_{dd} = 28\text{ V}$, $V_{gg1, 2, 3} = -4\text{ V}$, $I_{dd} = 400\text{ mA}$, $T_A = 25\text{ }^\circ\text{C}$

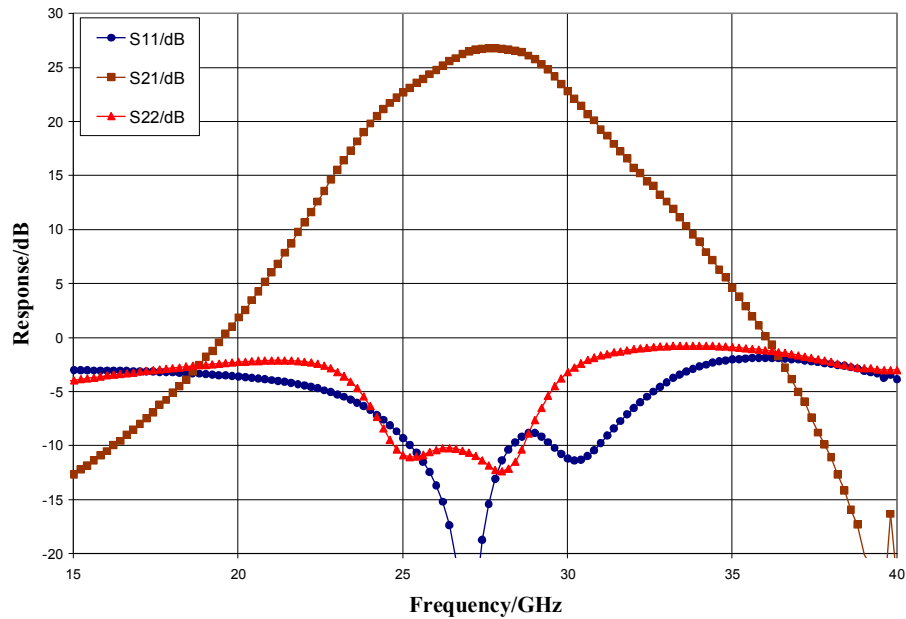

Narrow-band Performance, $V_{dd} = 28\text{ V}$, $V_{gg1, 2, 3} = -4\text{ V}$, $I_{dd} = 400\text{ mA}$, $T_A = 25\text{ }^\circ\text{C}$

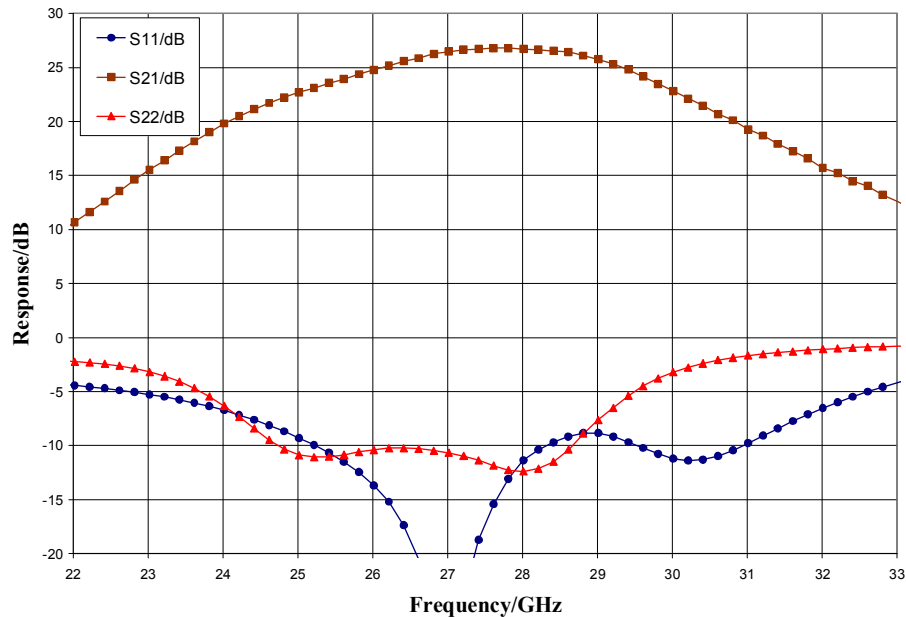

ver 1.2 0519

Typical Performance

Output Power and Power Added Efficiency, $V_{dd} = 28\text{ V}$, $V_{gg1,2,3} = -4\text{ V}$, $T_A = 25\text{ }^\circ\text{C}$

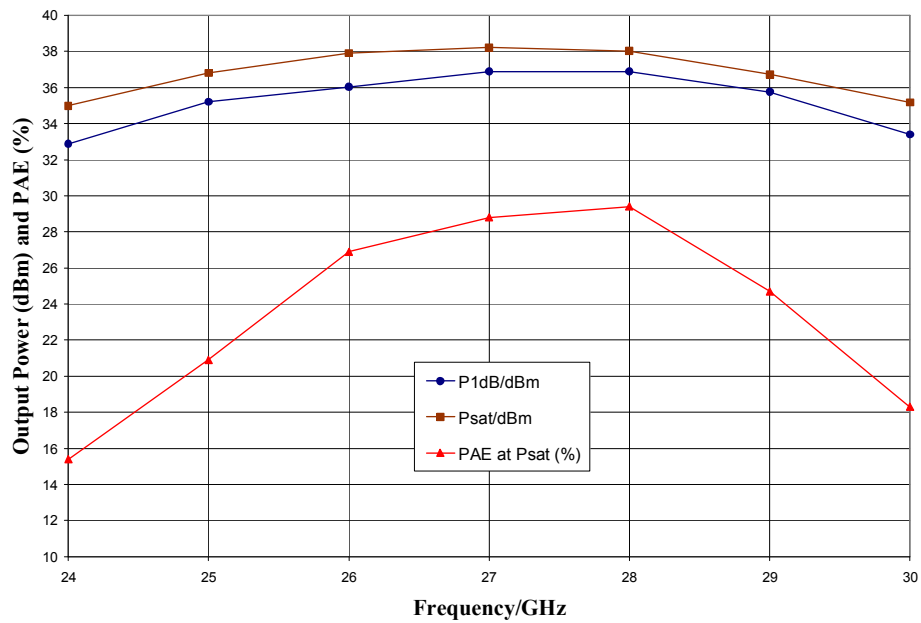

Mechanical Information

Die Outline (all dimensions in microns)

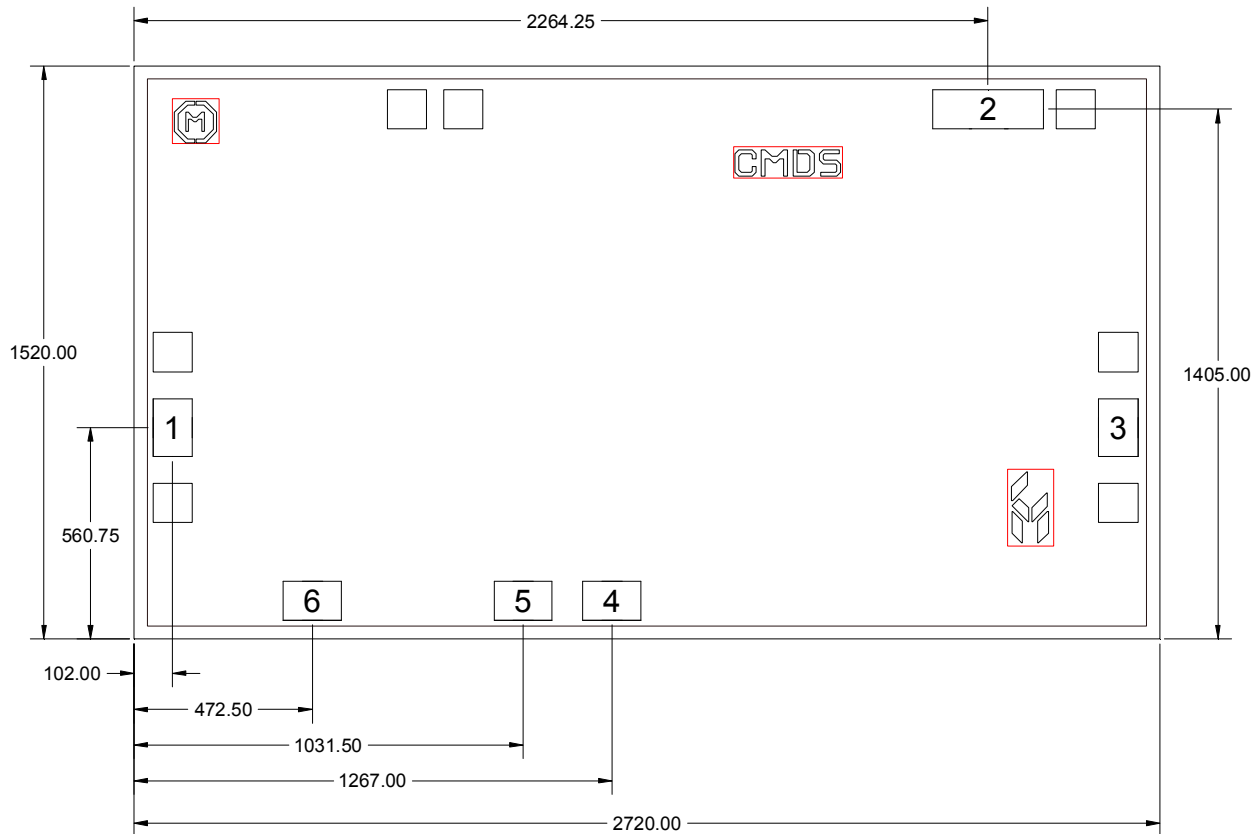

Notes:

1. No connection required for unlabeled pads
2. Backside is RF and DC ground
3. Backside and bond pad metal: Gold
4. Die is 100 microns thick
5. RF bond pads (1, 3) are 100 x 150 microns
6. DC bond pad (2) is 100 x 300 microns
7. DC bond pads (4, 5, 6) are 100 x 150 microns



ver 1.2 0519

Pin Description

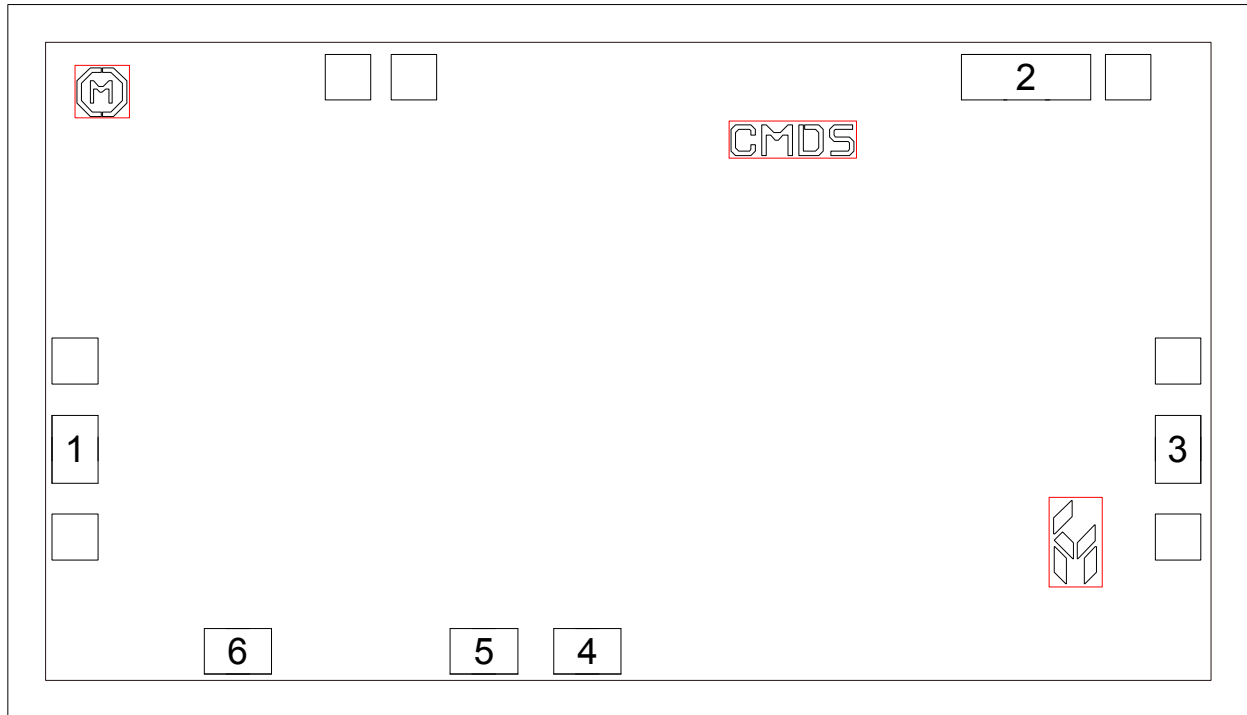
Pad Diagram

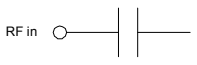
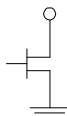
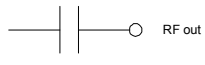
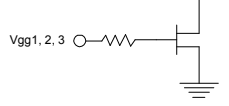

Functional Description

Pad	Function	Description	Schematic
1	RF in	DC blocked and 50 ohm matched	
2	Vdd	Power supply voltage Decoupling and bypass caps required	
3	RF out	DC blocked and 50 ohm matched	
4, 5, 6	Vgg3, 2, 1	Power supply voltage Decoupling and bypass caps required	
Backside	Ground	Connect to RF / DC ground	

ver 1.2 0519

Applications Information

Assembly Guidelines

The backside of the CMD262 is RF ground. Die attach should be accomplished with electrically and thermally conductive epoxy or eutectic attach. Standard assembly procedures should be followed for high frequency devices. The top surface of the semiconductor should be made planar to the adjacent RF transmission lines, and the RF decoupling capacitors placed in close proximity to the DC connections on chip.

RF connections should be made as short as possible to reduce the inductive effect of the bond wire. Use of a 0.8 mil thermosonic wedge bonding is highly recommended as the loop height will be minimized. The RF input and output require a double bond wire as shown.

The semiconductor is 100 um thick and should be handled by the sides of the die or with a custom collet. Do not make contact directly with the die surface as this will damage the monolithic circuitry. Handle with care.

Assembly Diagram

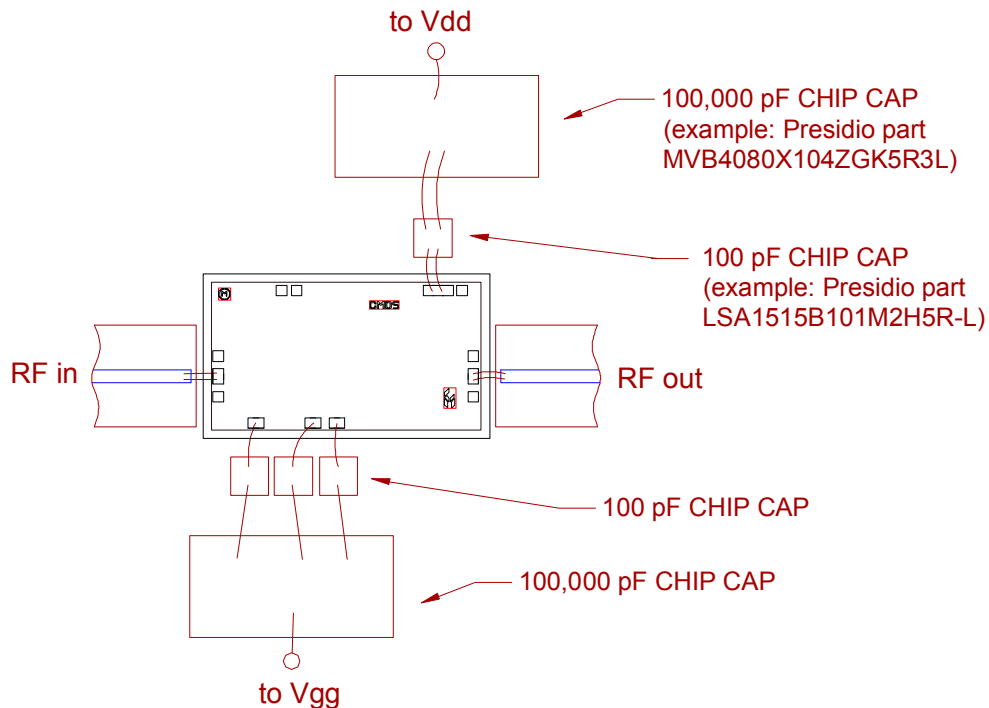

GaAs MMIC devices are susceptible to damage from Electrostatic Discharge. Proper precautions should be observed during handling, assembly and test.

ver 1.2 0519

Applications Information

Biasing and Operation

The CMD262 is biased with a positive drain supply and a negative gate supply. Performance is optimized when the drain voltage is set to +28 V. The nominal gate voltage is -4 V.

Turn ON procedure:

1. Apply gate voltage V_{gg} and set to -6 V
2. Apply drain voltage V_{dd} and set to +28 V
3. Increase V_{gg} (less negative) to achieve a drain current of 400 mA

Turn OFF procedure:

1. Turn off drain voltage V_{dd}
2. Turn off gate voltage V_{gg}

RF power can be applied at any time.