



# CMD256

## Frequency Doubler, 14-20 GHz Input

### Features

- ▶ Low conversion loss
- ▶ Excellent Fo isolation
- ▶ Broadband performance
- ▶ No bias required
- ▶ Small die size

### Description

The CMD256 die is a broadband MMIC GaAs x2 passive frequency multiplier. When driven by a +15 dBm signal, the multiplier provides 15 dB conversion loss at an output frequency of 34 GHz. The Fo isolation is 38 dBc. The CMD256 is a 50 ohm matched design eliminating the need for RF port matching.

### Functional Block Diagram

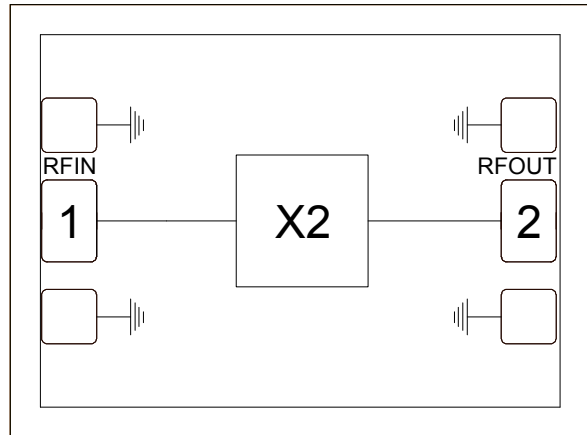

### Electrical Performance - $T_A = 25^\circ\text{C}$ , $P_{in} = +15\text{ dBm}$ , $F_{in} = 17\text{ GHz}$

Parameter	Min	Typ	Max	Units
Frequency Range, Input	14 - 20			GHz
Frequency Range, Output	28 - 40			GHz
Conversion Loss		15		dB
Fo Isolation (with respect to input level)		38		dB

ver 1.0 0318



# CMD256

## Frequency Doubler, 14-20 GHz Input

### Specifications

#### Absolute Maximum Ratings

Parameter	Rating
RF Input Power	+27 dBm
Operating Temperature	-55 to 85 °C
Storage Temperature	-55 to 150 °C

Exceeding any one or combination of the maximum ratings may cause permanent damage to the device.

#### Electrical Specifications - $T_A = 25\text{ °C}$ , $P_{in} = +15\text{ dBm}$

Parameter	Min	Typ	Max	Min	Typ	Max	Units
Frequency Range, Input	14 - 20			16 - 18			GHz
Frequency Range, Output	28 - 40			32 - 36			GHz
Conversion Loss		16	20		15	19	dB
Fo Isolation (with respect to input level)	32	40		32	40		dB

ver 1.0 0318

### Typical Performance

#### Conversion Gain vs. Temperature @ +15 dBm Drive Level

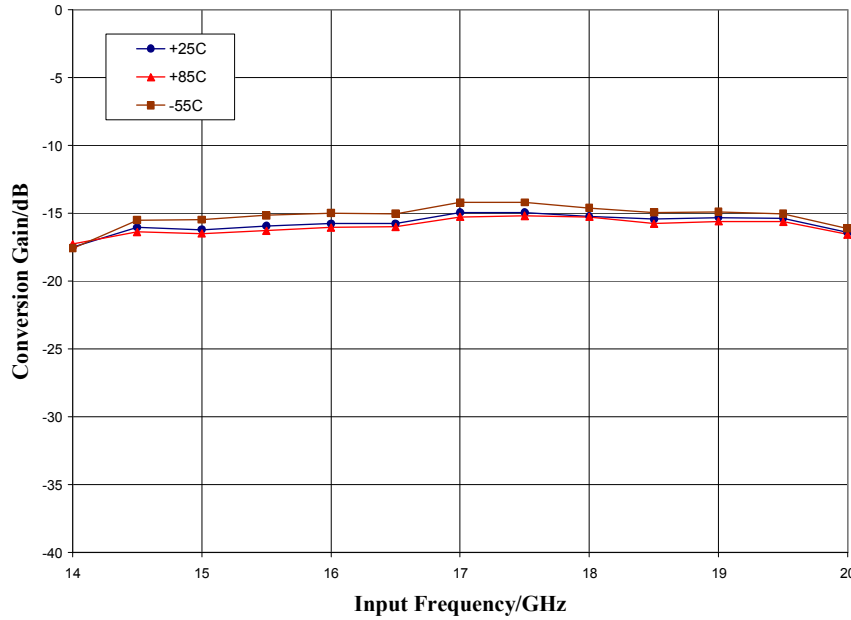

#### Conversion Gain vs. Drive Level, T<sub>A</sub> = 25 °C

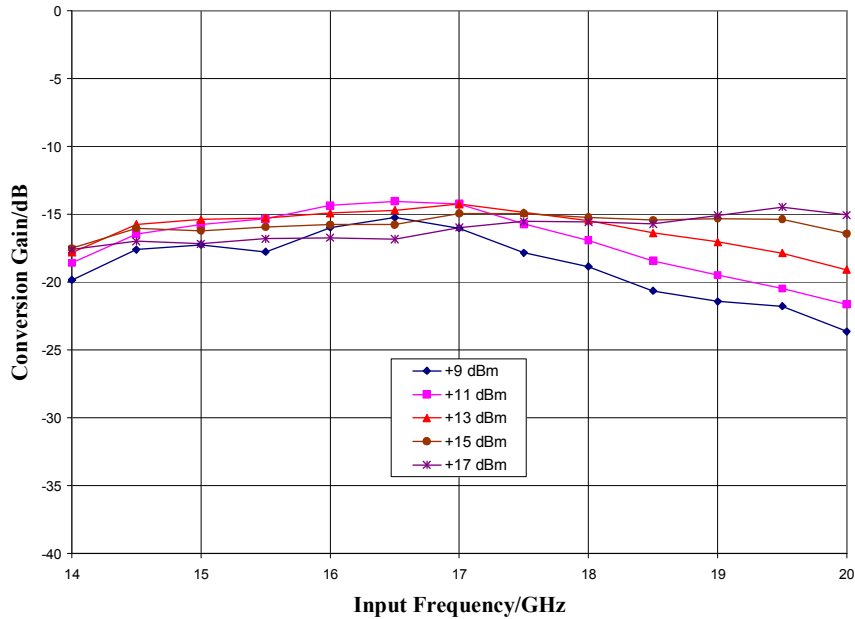

ver 1.0

### Typical Performance

**Fo Isolation (with respect to input level) @ +15 dBm Drive Level, T<sub>A</sub> = 25 °C**

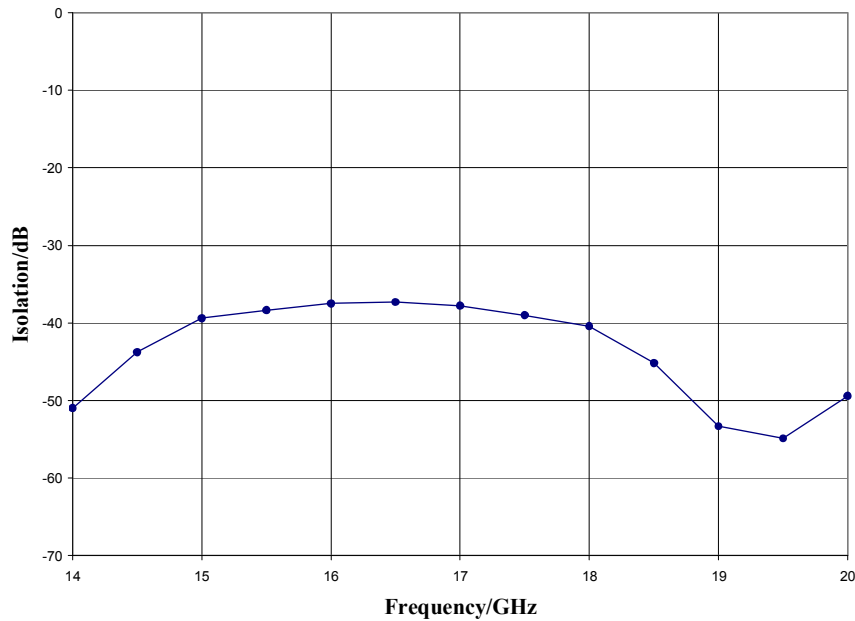

**Output Spectrum @ +15 dBm Drive Level, T<sub>A</sub> = 25 °C**

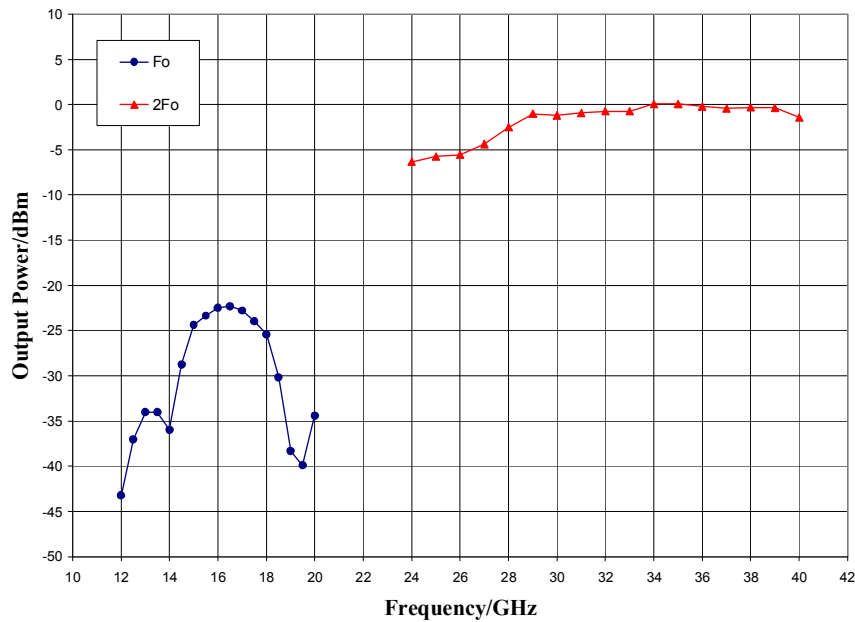

## Typical Performance

Input Return Loss @ +15 dBm Drive Level,  $T_A = 25^\circ\text{C}$

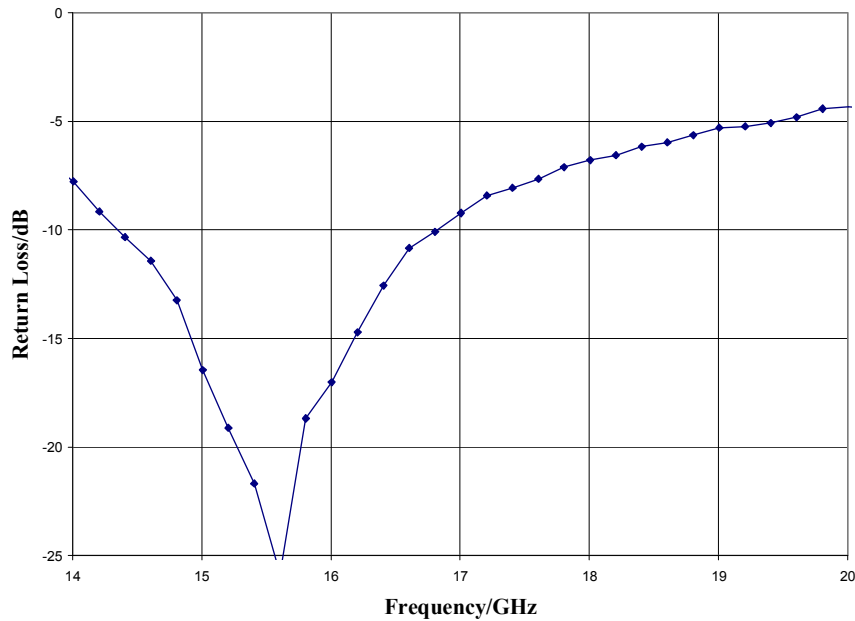

Output Return Loss @ +15 dBm Drive Level,  $F = 11.5$  GHz Input,  $T_A = 25^\circ\text{C}$

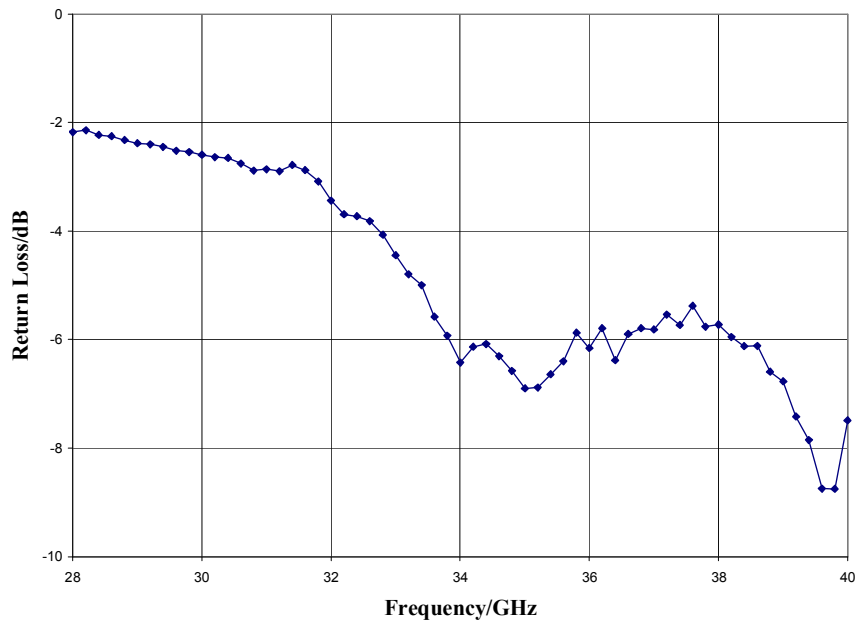

ver 1.0 0318

## Mechanical Information

### Die Outline (all dimensions in microns)

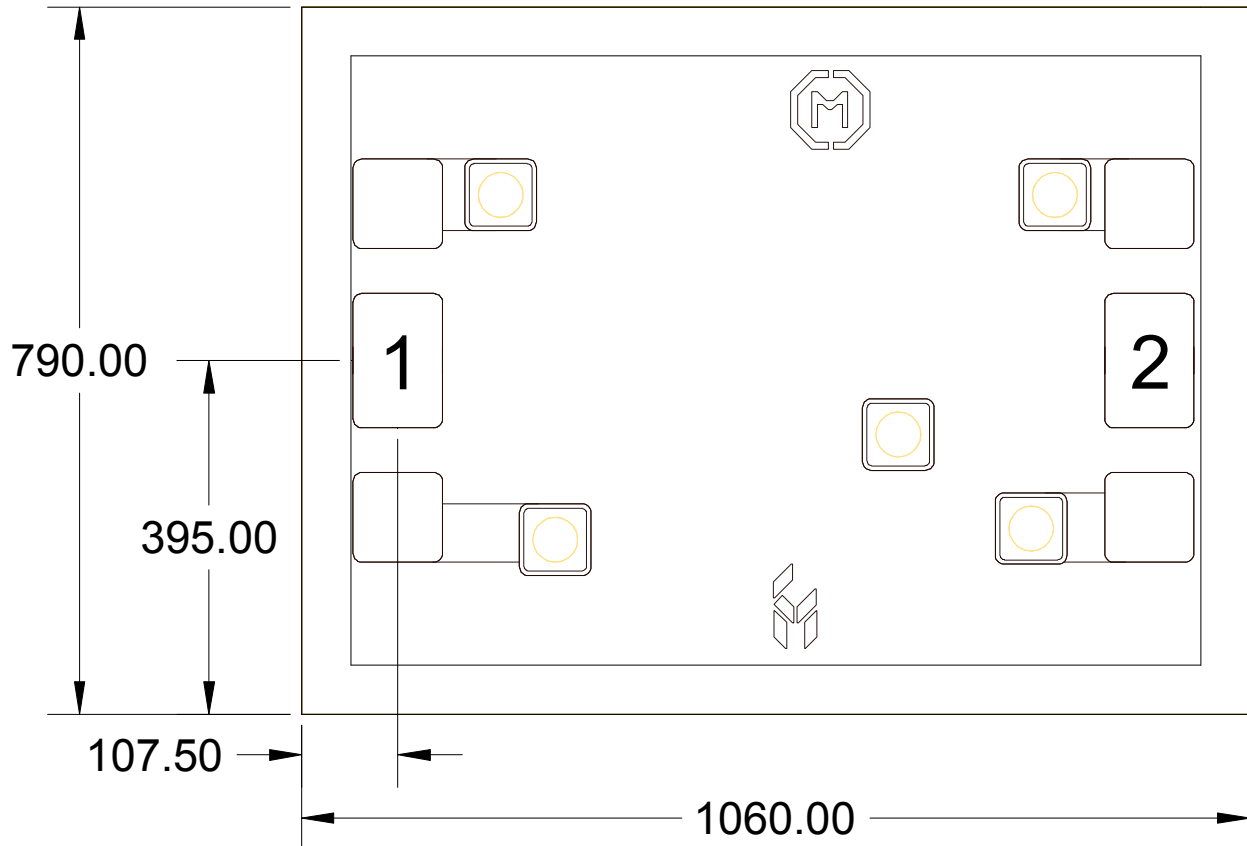

#### Notes:

1. No connection required for unlabeled pads
2. Backside is RF and DC ground
3. Backside and bond pad metal: Gold
4. Die is 100 microns thick
5. RF bond pads are 100 x 150 microns

## Pin Description

### Pad Diagram

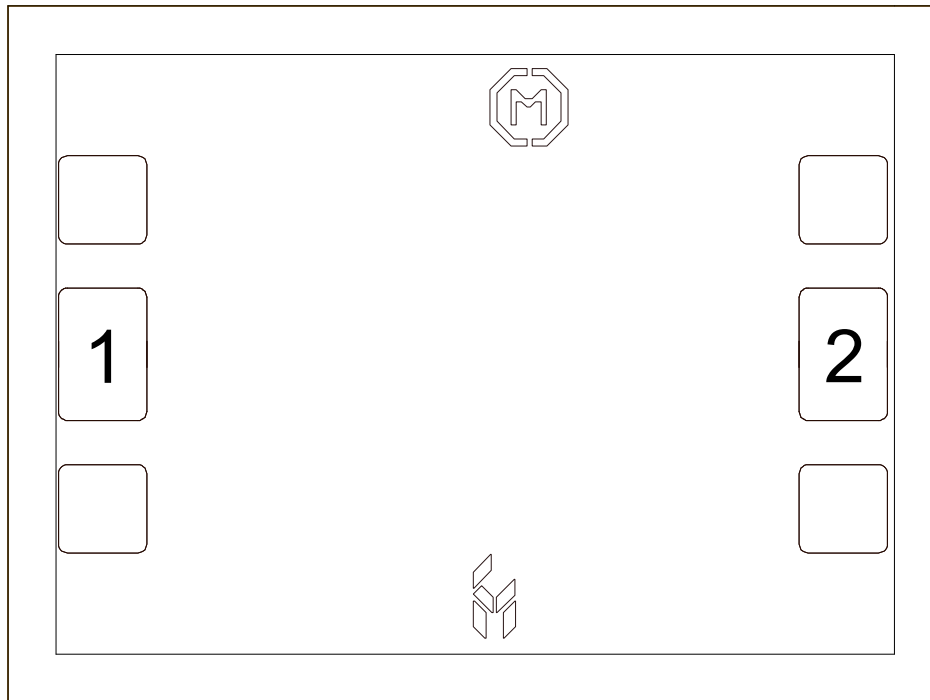

### Functional Description

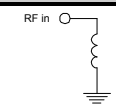
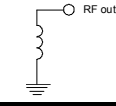
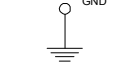
Pad	Function	Description	Schematic
1	RF in	Pad is DC coupled and 50 ohm matched	
2	RF out	Pad is DC coupled and 50 ohm matched	
Backside	Ground	Connect to RF / DC ground	

ver 1.0 0318

### Applications Information

#### Assembly Guidelines

The backside of the CMD256 is RF ground. Die attach should be accomplished with electrically and thermally conductive epoxy or eutectic attach. Standard assembly procedures should be followed for high frequency devices. The top surface of the semiconductor should be made planar to the adjacent RF transmission lines.

RF connections should be made as short as possible to reduce the inductive effect of the bond wire. Use of a 0.8 mil thermosonic wedge bonding is highly recommended as the loop height will be minimized. The RF input and output require double bond wires as shown.

The semiconductor is 100 um thick and should be handled by the sides of the die or with a custom collet. Do not make contact directly with the die surface as this will damage the monolithic circuitry. Handle with care.

#### Assembly Diagram

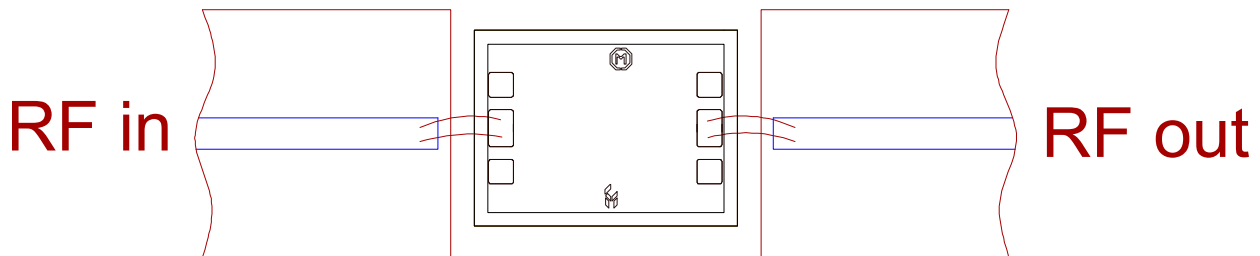

**GaAs MMIC devices are susceptible to damage from Electrostatic Discharge. Proper precautions should be observed during handling, assembly and test.**

*Please note, all information contained in this data sheet is subject to change without notice.*

ver 1.0 0318