

### Features

- ▶ Low conversion loss
- ▶ High IP3
- ▶ High isolation
- ▶ Wide IF bandwidth
- ▶ Pb-free RoHs compliant 3x3 mm SMT package

### Description

The CMD255C3 is a general purpose double balanced mixer in a leadless surface mount package that can be used for up- and downconverting applications between 16 and 26 GHz. The CMD255C3 has very high isolation to both the RF and IF ports due to the optimized balun structures, and can operate with an LO drive level as low as +15 dBm. The CMD255C3 can easily be configured as an image reject mixer or single sideband modulator with external hybrids and power splitters.

### Functional Block Diagram

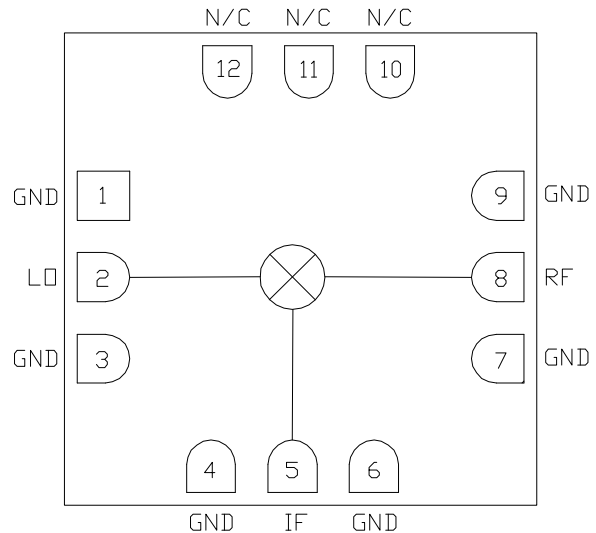

### Electrical Performance - IF = 100 MHz, LO = +19 dBm, T<sub>A</sub> = 25 °C, F = 21 GHz

Parameter	Min	Typ	Max	Units
Frequency Range, RF & LO	16 - 26			GHz
Frequency Range, IF	DC		9	GHz
Conversion Loss		6.5		dB
LO to RF Isolation		40		dB
LO to IF Isolation		33		dB
RF to IF Isolation		30		dB
Input P1dB		14.5		dBm
Input IP3		24		dBm

Unless otherwise noted, all measurements performed as a downconverter, IF = 100 MHz

ver 1.0 1017



# CMD255C3

## 16-26 GHz High IP3 Fundamental Mixer

### Specifications

#### Absolute Maximum Ratings

Parameter	Rating
RF / IF Input Power	+25 dBm
LO Drive	+25 dBm
Operating Temperature	-40 to 85 °C
Storage Temperature	-55 to 150 °C
Thermal Resistance, $\Theta_{JC}$	268 °C/W

Operation of this device outside the maximum ratings may cause permanent damage.

#### Electrical Specifications - IF = 100 MHz, LO = +19 dBm, $T_A = 25\text{ °C}$

Parameter	Min	Typ	Max	Min	Typ	Max	Units
Frequency Range, RF & LO	18 - 24			16 - 26			GHz
Frequency Range, IF	DC		9	DC		9	GHz
Conversion Loss		6.5	8.5		7	10	dB
Noise Figure (SSB)		6.5			7		dB
LO to RF Isolation	32	40		32	40		dB
LO to IF Isolation	26	33		25	33		dB
RF to IF Isolation	20	30		18	30		dB
Input P1dB		14.5			14.5		dBm
Input IP3		23			23		dBm

Unless otherwise noted, all measurements performed as a downconverter, IF = 100 MHz

ver 1.0 1017

### Typical Performance

**Conversion Gain vs. Temperature, LO = +19 dBm, IF = 100 MHz USB**

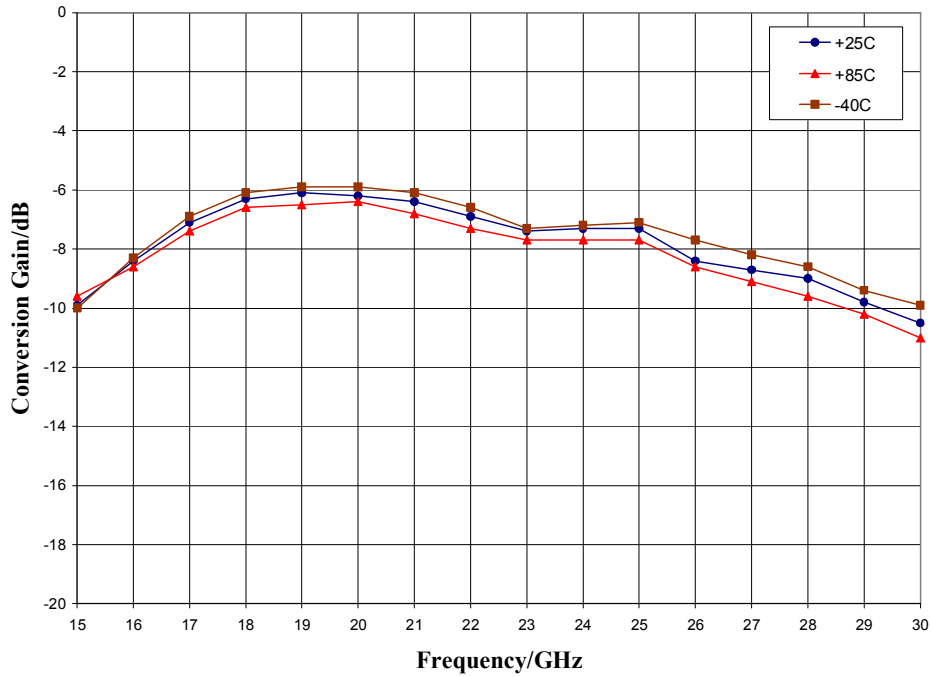

**Isolation, LO = +19 dBm**

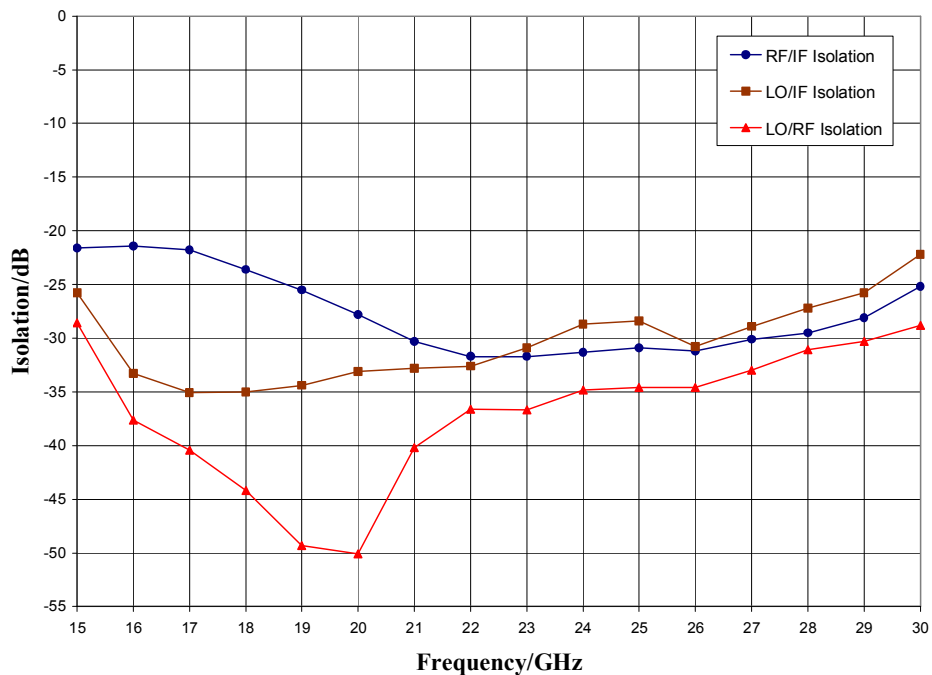

ver 1.0 1017

### Typical Performance

**Conversion Gain vs. LO Drive, IF = 100 MHz USB**

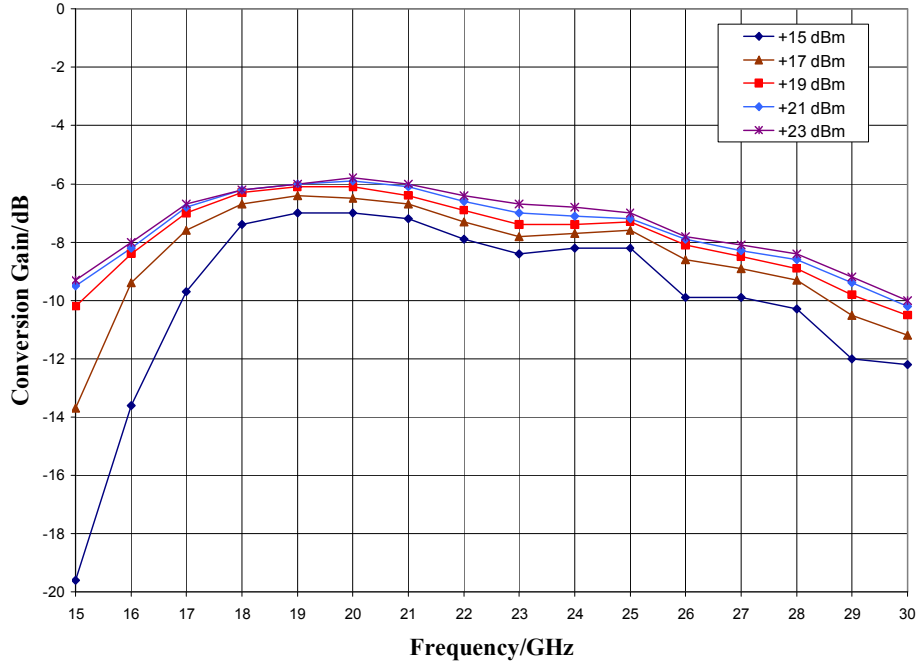

**Return Loss, LO = + 19 dBm**

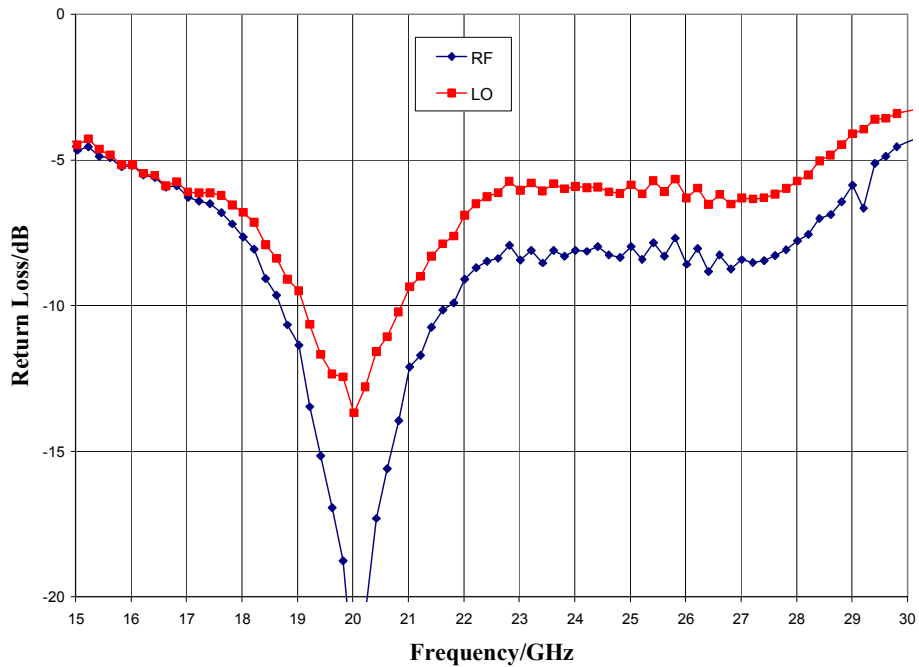

ver 1.0 1017

### Typical Performance

#### IF Bandwidth, LO = +19 dBm

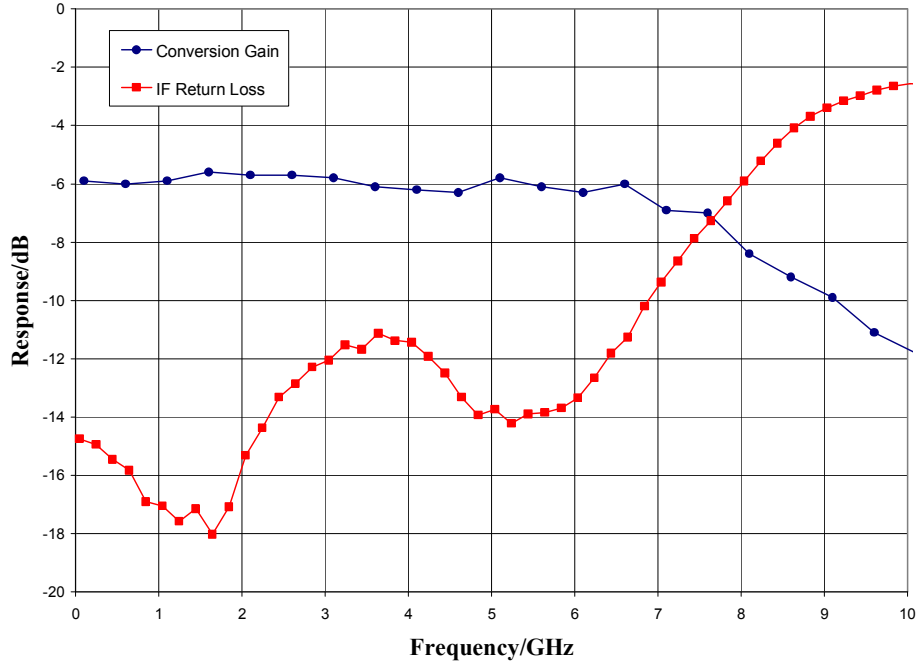

#### Upconverter Performance, Conversion Gain vs. LO Drive, IF input = 950 MHz

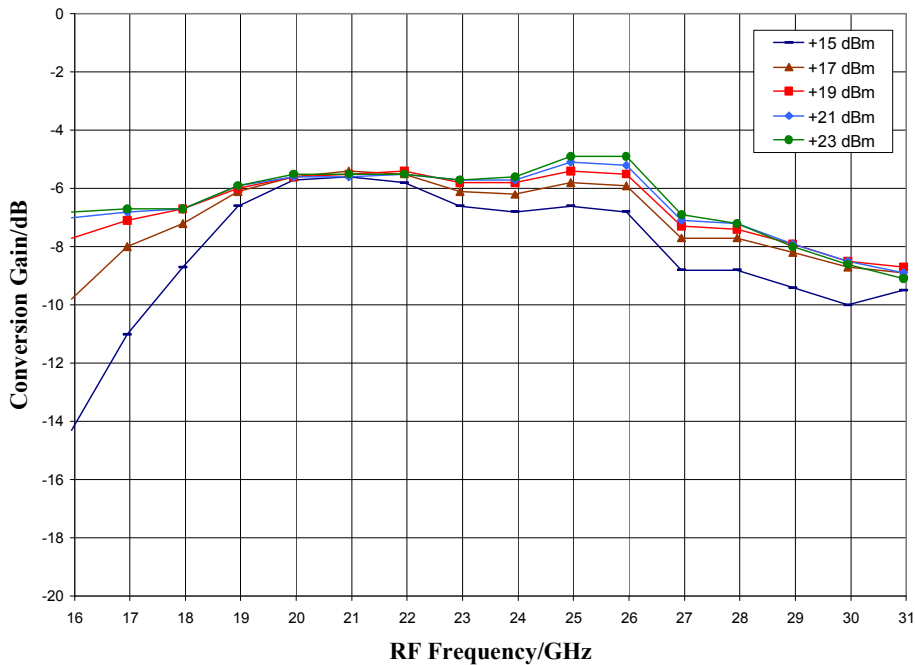

ver 1.0 1017

### Typical Performance

**Input IP3 vs. Temperature, LO = +19 dBm, IF = 100 MHz**

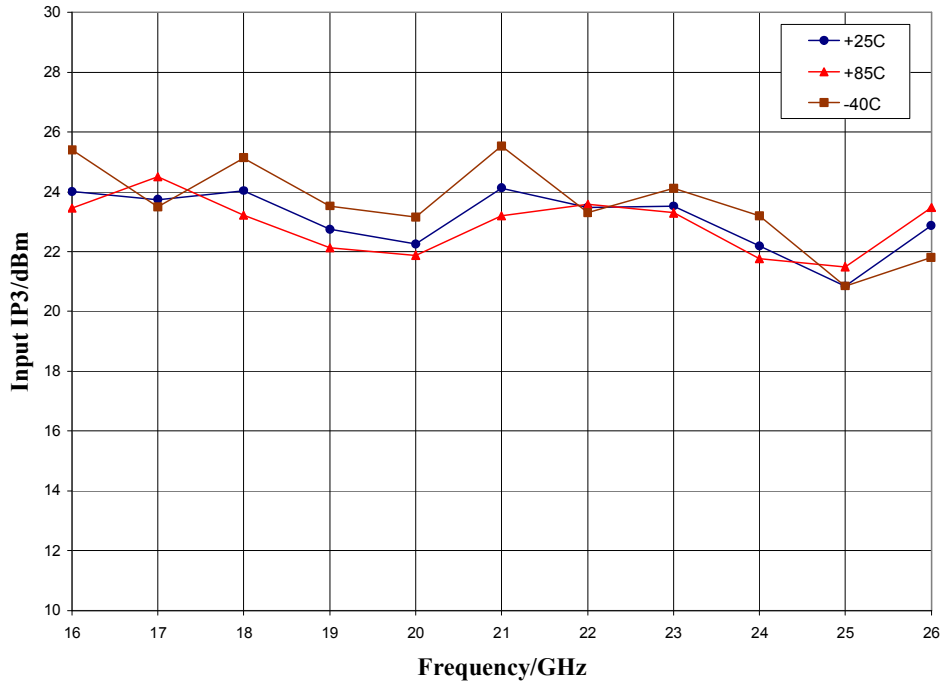

**Input IP3 vs. LO Drive, IF = 100 MHz**

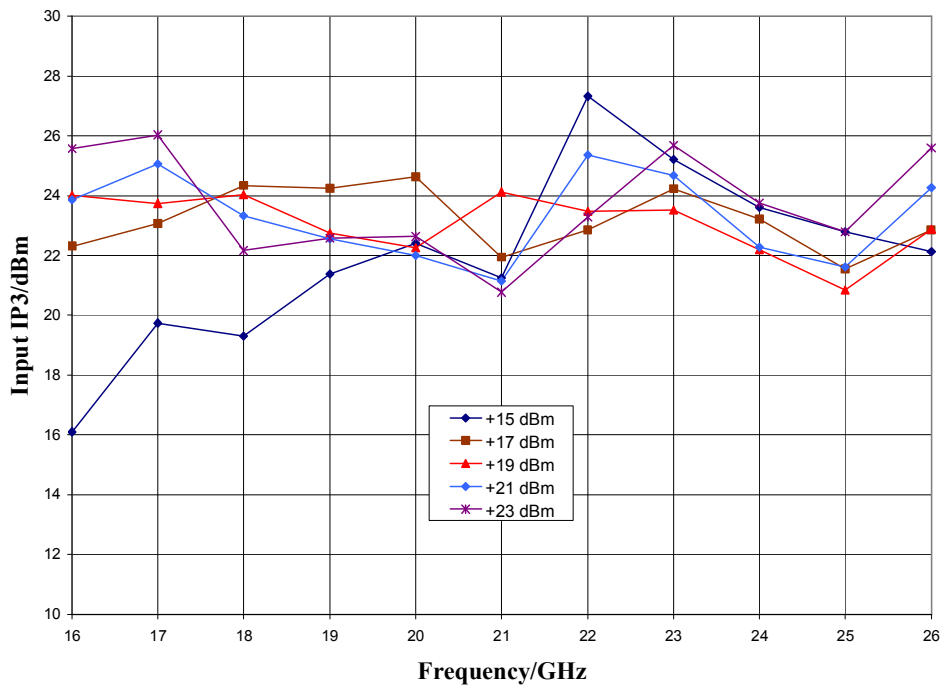

ver 1.0 1017

### Typical Performance

**Upconverter Performance, Input IP3 vs. LO Drive, IF = 100 MHz**

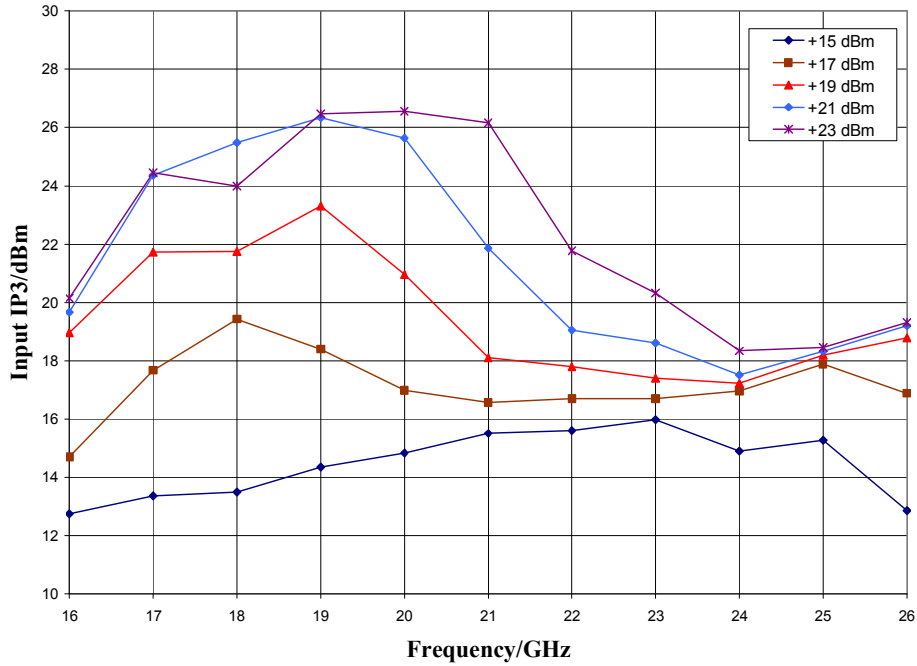

**Input P1dB vs. Temperature, LO = +19 dBm, IF = 100 MHz USB**

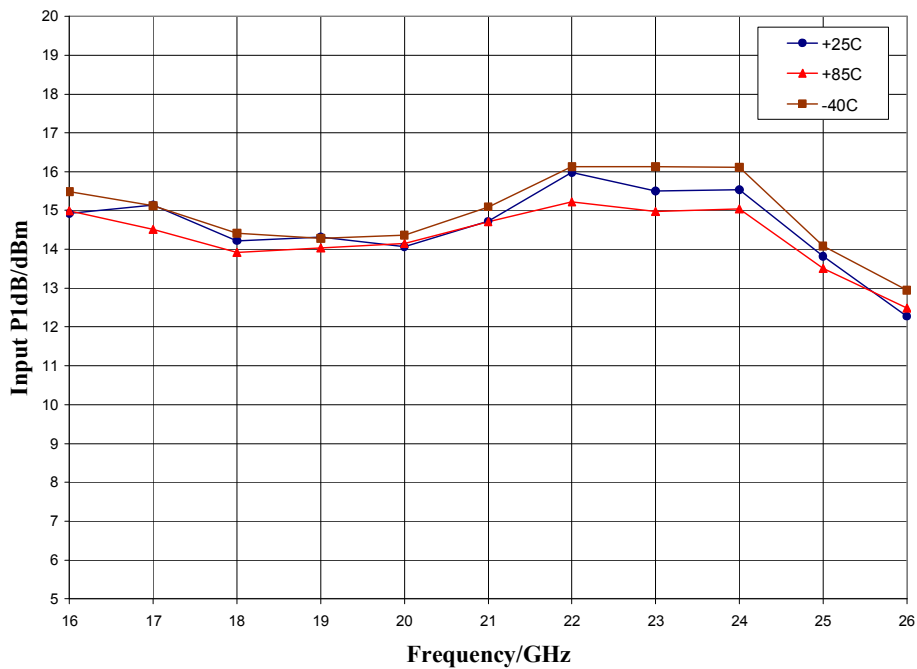

ver 1.0 1017

### Typical Performance

#### MxN Spurious Outputs

mRF	nLO				
	0	1	2	3	4
0	xx	6			
1	23	0	41		
2		59	54	59	
3			> 64	> 64	> 64
4				> 64	> 64

RF = 21.1 GHz @ -10 dBm  
LO = 21.0 GHz @ +19 dBm



### Mechanical Information

#### Package Information and Dimensions

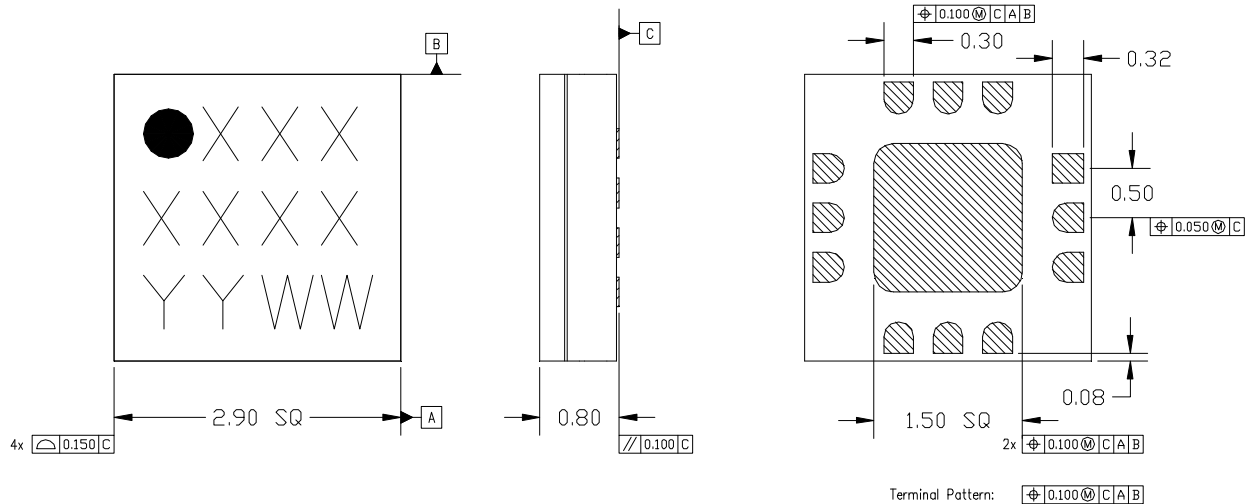

#### NOTES:

1. ALL DIMENSIONS SHOWN IN mm.
2. MATERIAL: BLACK ALUMINA
3. LEAD FINISH:
  - 3.1. Ni: 8.89 $\mu$ m MAX, 1.27 $\mu$ m MIN
  - 3.2. Pd: 0.17 $\mu$ m MAX, 0.07 $\mu$ m MIN
  - 3.3. Au: 0.254 $\mu$ m MAX, 0.03 $\mu$ m MIN
4. MARKING
  - 4.1. LINE 1: PART NUMBER
    - 4.1.1. EXAMPLE: CMD177C3 SHALL BE MARKED AS 177
  - 4.2. LINE 2: LDT NUMBER
  - 4.3. LINE 3: DATE CODE - LAST 2 DIGITS OF THE YEAR OF MANUFACTURE FOLLOWED BY A 2 DIGIT WEEK CODE
5. ALTERNATE PIN #1 IDENTIFIER IS A SINGLE SQUARE PAD
6. ALTERNATE DIE PADDLE MAY HAVE CHAMFERED CORNERS

#### Recommended PCB Land Pattern

Custom MMIC Design Services recommends that the user develop the land pattern that will provide the best design for proper solder reflow and device attach for their specific application. Please review Custom MMIC Application Note AN 105 for a recommended land pattern approach.

#### Recommended Solder Reflow Profile

Custom MMIC Design Services recommends screen printing with belt furnace reflow to ensure proper solder reflow and device attach. Please review Custom MMIC Application Note AN 102 for a recommended solder reflow profile.

### Pin Description

#### Pin Diagram

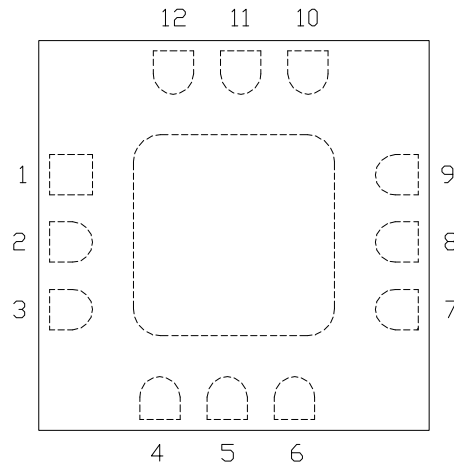

#### Functional Description

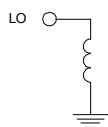
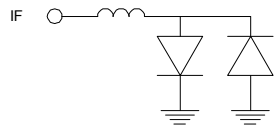
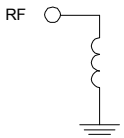
Pin	Function	Description	Schematic
1,3,4,6,7,9 and die paddle	Ground	Connect to RF / DC ground.	
2	LO	This pin is DC coupled and matched to 50 ohms.	
5	IF	This pin is DC coupled. For applications not requiring operation to DC, this port should be DC blocked externally using a series capacitor whose value has been chosen to pass the necessary IF frequency range. For operation to DC, this pin must not source or sink more than 16 mA of current or part non-function or part failure may result.	
8	RF	This pin is DC coupled and matched to 50 ohms.	
10-12	N/C	No connection required. These pins may be connected to RF/DC ground	

ver 1.0 1017

### Applications Information

#### Evaluation Board

The circuit board shown has been developed for optimized assembly at Custom MMIC. A sufficient number of via holes should be used to connect the top and bottom ground planes. As surface mount processes vary, careful process development is recommended.

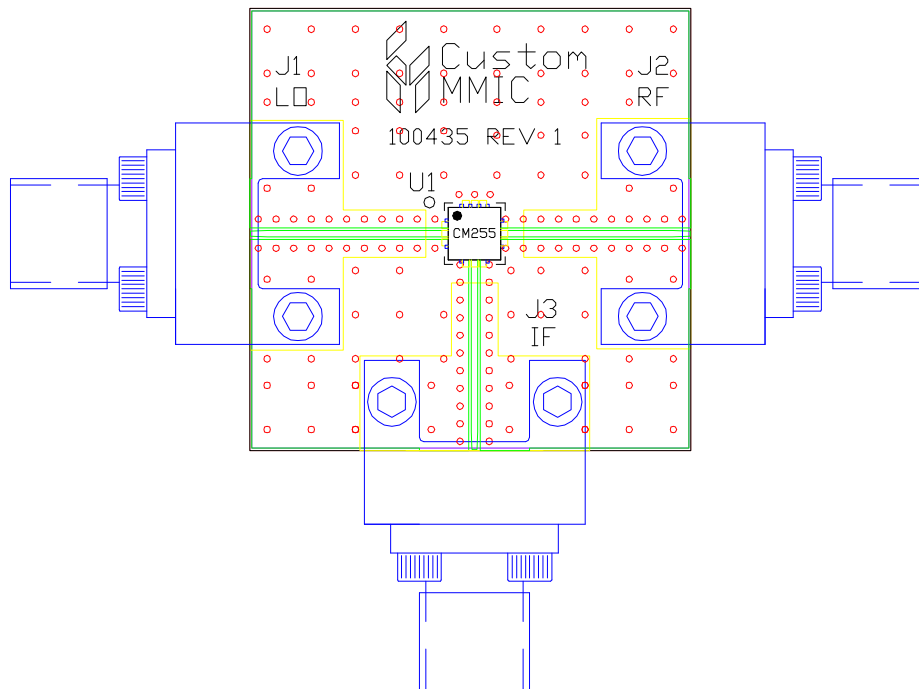

#### Bill of Material

Designator	Value	Description
J1 - J3		SMA End Launch Connector
U1		CMD255C3 Fundamental Mixer
PCB		100435 Evaluation PCB

**GaAs MMIC devices are susceptible to damage from Electrostatic Discharge. Proper precautions should be observed during handling, assembly and test.**

*Please note, all information contained in this data sheet is subject to change without notice.*

ver 1.0 1017