



CMD253C3

6-14 GHz High IP3 Fundamental Mixer

Features

- ▶ Low conversion loss
- ▶ High IP3
- ▶ High Isolation
- ▶ Wide IF bandwidth
- ▶ Pb-free RoHs compliant 3x3 mm SMT package

Description

The CMD253C3 is a high IP3 double balanced mixer in a leadless surface mount package that can be used for up- and downconverting applications between 6 and 14 GHz. The CMD253C3 has very high isolation to both the RF and IF ports due to the optimized balun structures, and can operate with an LO drive level as low as +15 dBm. The CMD253C3 can easily be configured as an image reject mixer or single sideband modulator with external hybrids and power splitters.

Functional Block Diagram

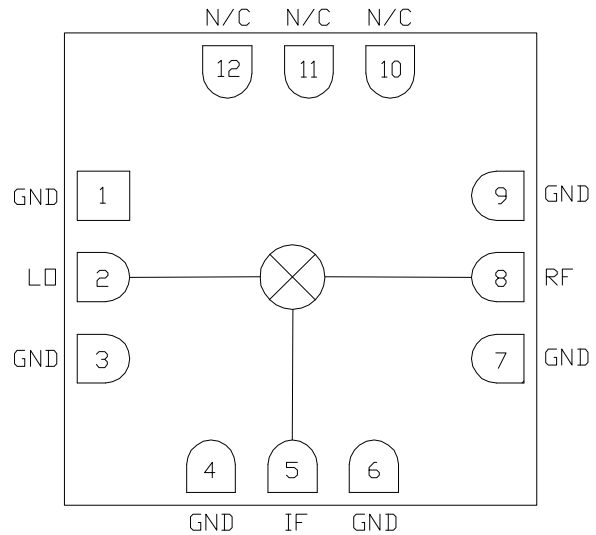

Electrical Performance - IF = 100 MHz, LO = +19 dBm, T_A = 25 °C, F = 10 GHz

Parameter	Min	Typ	Max	Units
Frequency Range, RF & LO	6 - 14			GHz
Frequency Range, IF	DC		5	GHz
Conversion Loss		6		dB
LO to RF Isolation		43		dB
LO to IF Isolation		39		dB
RF to IF Isolation		23		dB
Input P1dB		15		dBm
Input IP3		23		dBm

Unless otherwise noted, all measurements performed as a downconverter, IF = 100 MHz

ver 1.0 1017



CMD253C3

6-14 GHz High IP3 Fundamental Mixer

Specifications

Absolute Maximum Ratings

Parameter	Rating
RF / IF Input Power	+25 dBm
LO Drive	+25 dBm
Operating Temperature	-40 to 85 °C
Storage Temperature	-55 to 150 °C
Thermal Resistance, Θ_{JC}	156 °C/W

Operation of this device outside the maximum ratings may cause permanent damage.

Electrical Specifications - IF = 100 MHz, LO = +19 dBm, $T_A = 25\text{ °C}$

Parameter	Min	Typ	Max	Min	Typ	Max	Units
Frequency Range, RF & LO	8 - 12			6 - 14			GHz
Frequency Range, IF	DC		5	DC		5	GHz
Conversion Loss		6.5	8		7	11	dB
Noise Figure (SSB)		6.5			7		dB
LO to RF Isolation	35	43		32	43		dB
LO to IF Isolation	29	39		25	39		dB
RF to IF Isolation	15	23		12	23		dB
Input P1dB		15			15		dBm
Input IP3		23			23		dBm

Unless otherwise noted, all measurements performed as a downconverter, IF = 100 MHz

ver 1.0 1017

Typical Performance

Conversion Gain vs. Temperature, LO = +19 dBm, IF = 100 MHz USB

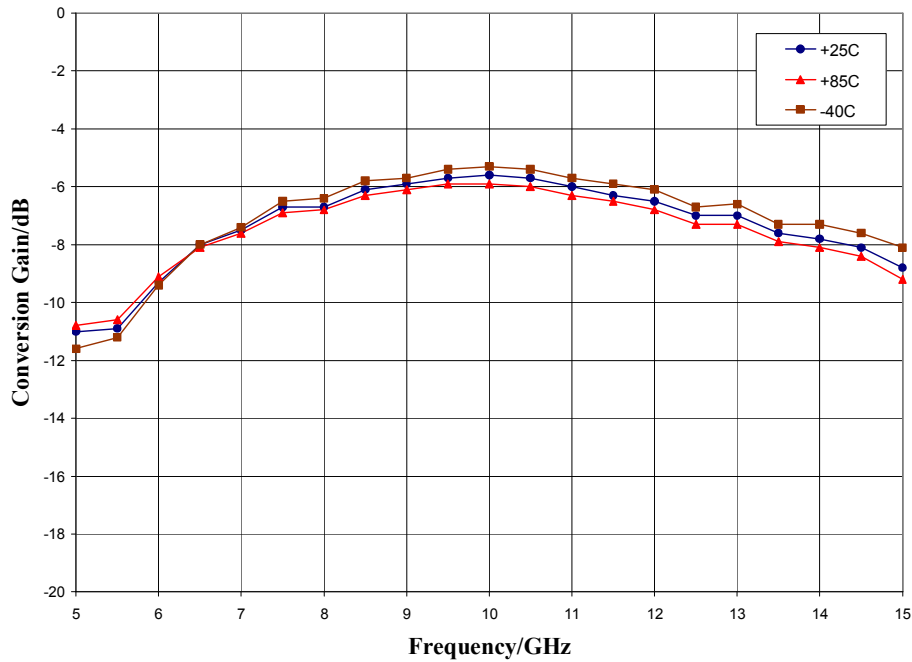

Isolation, LO = +19 dBm

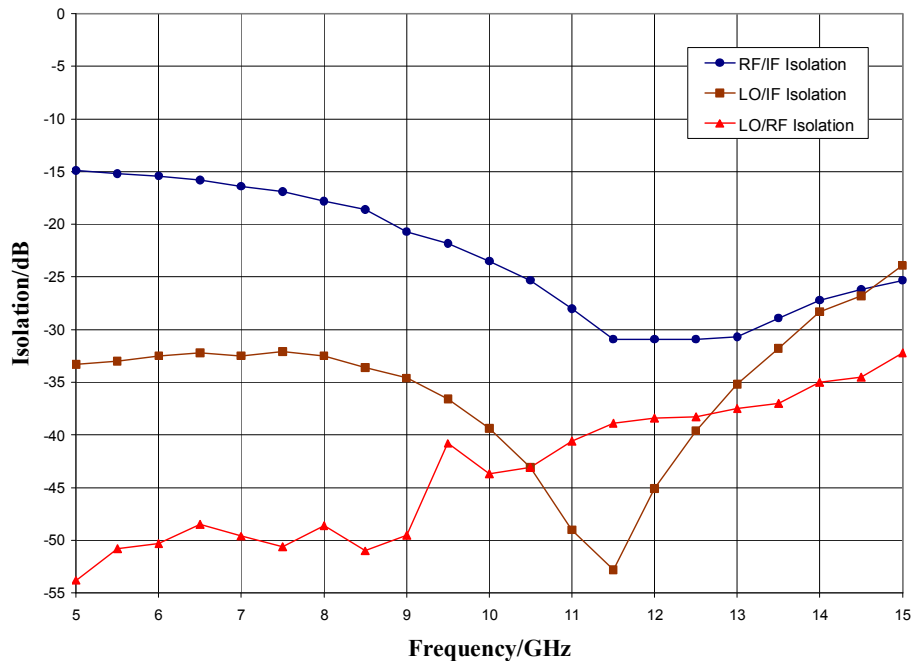

ver 1.0 1017

Typical Performance

Conversion Gain vs. LO Drive, IF = 100 MHz USB

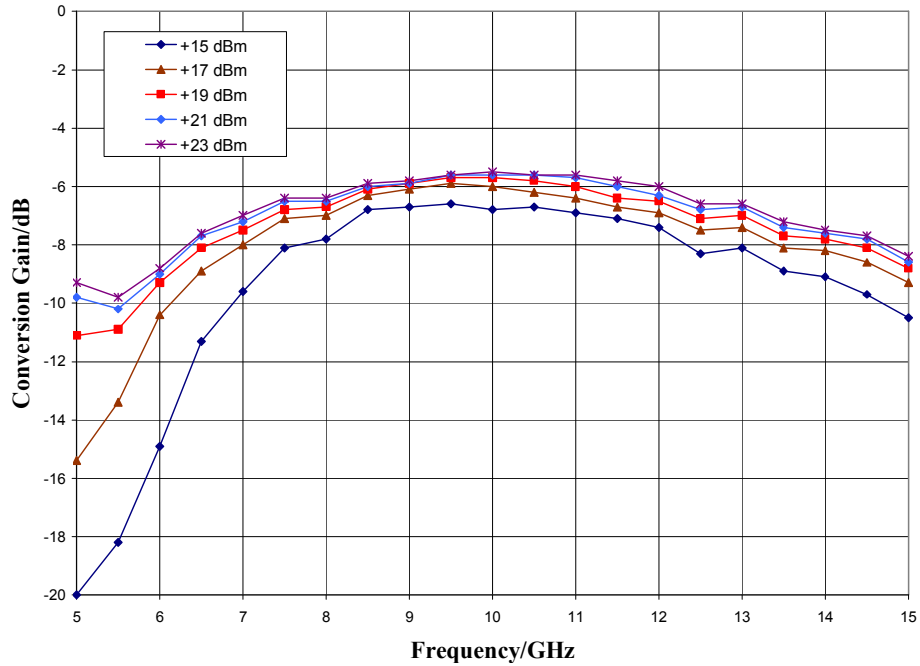

Return Loss, LO = + 19 dBm

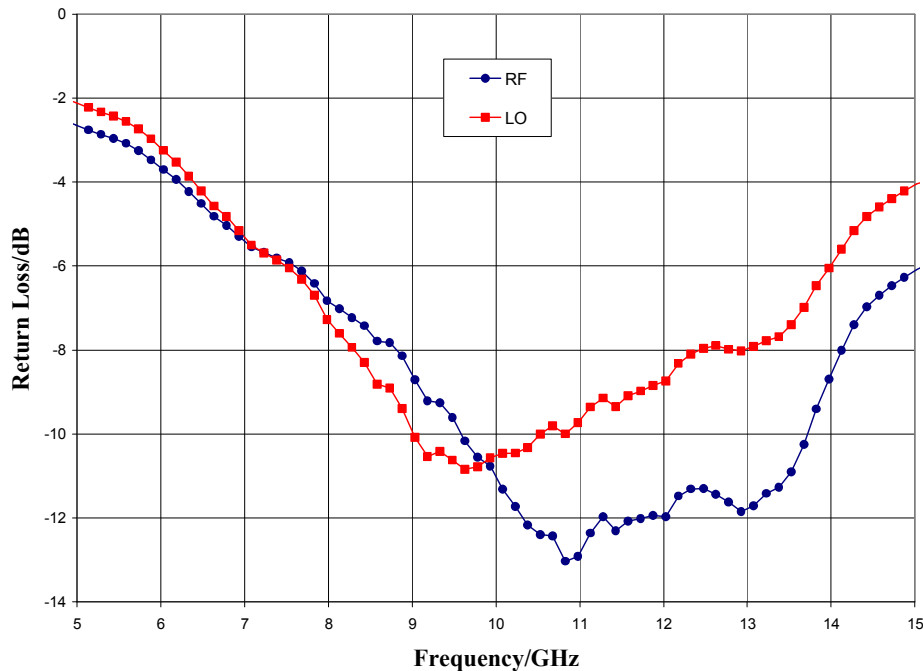

ver 1.0 1017

Typical Performance

IF Bandwidth, LO = +19 dBm

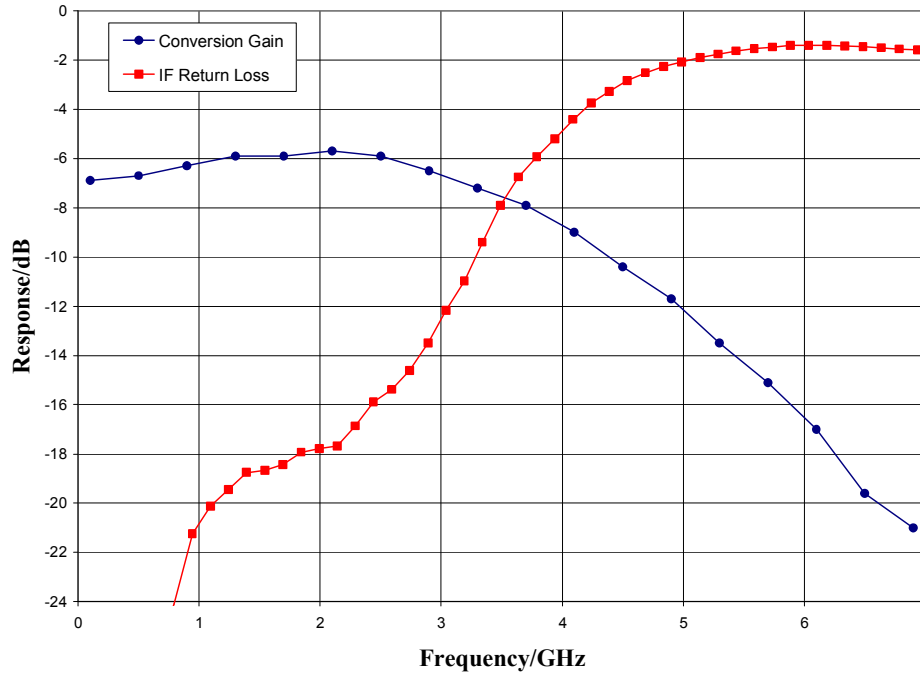

Upconverter Performance, Conversion Gain vs. LO Drive, IF input = 950 MHz

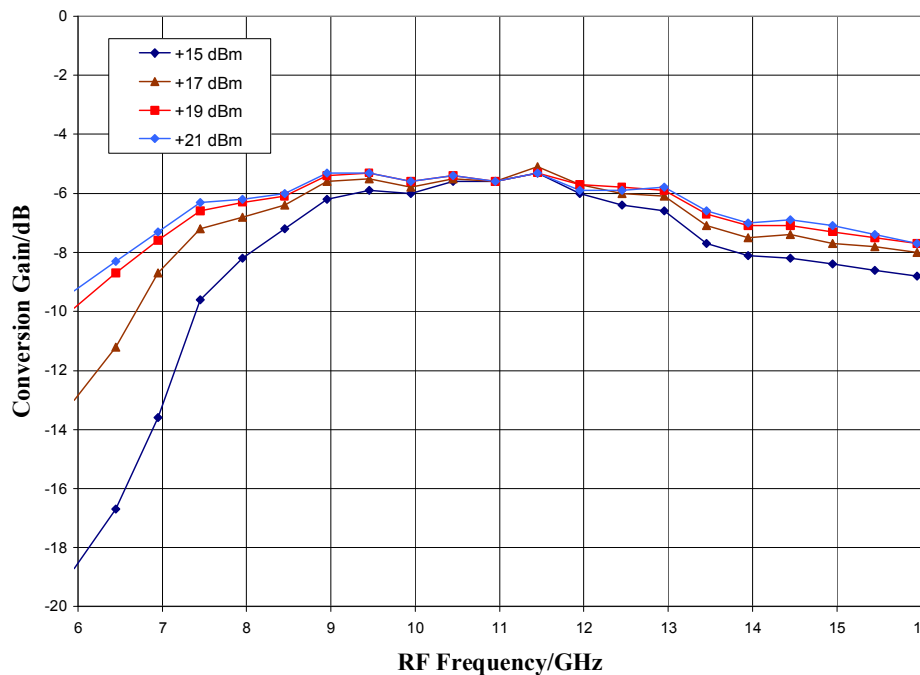

ver 1.0 1017

Typical Performance

Input IP3 vs. Temperature, LO = +19 dBm, IF = 100 MHz

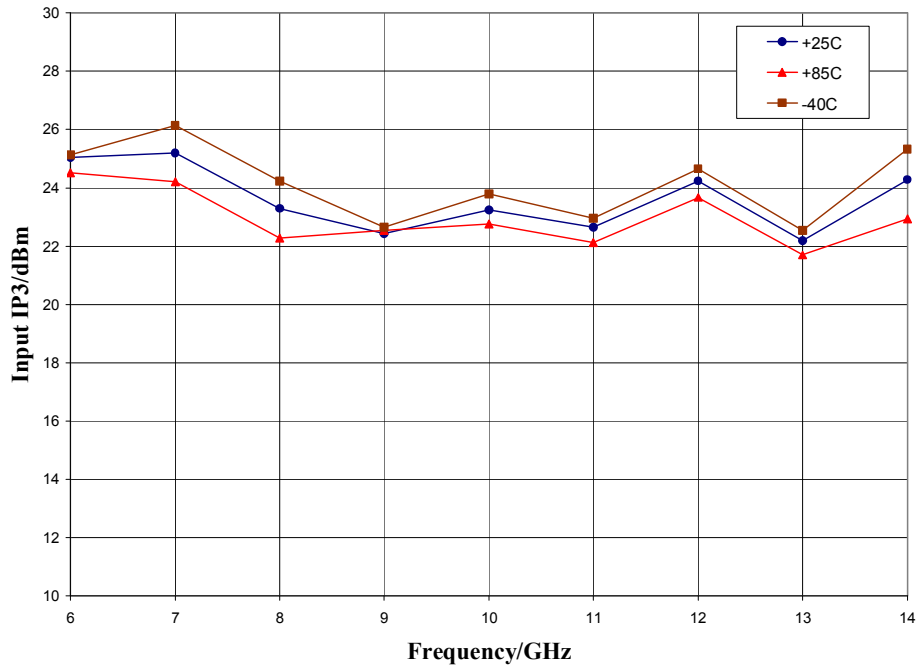

Input IP3 vs. LO Drive, IF = 100 MHz

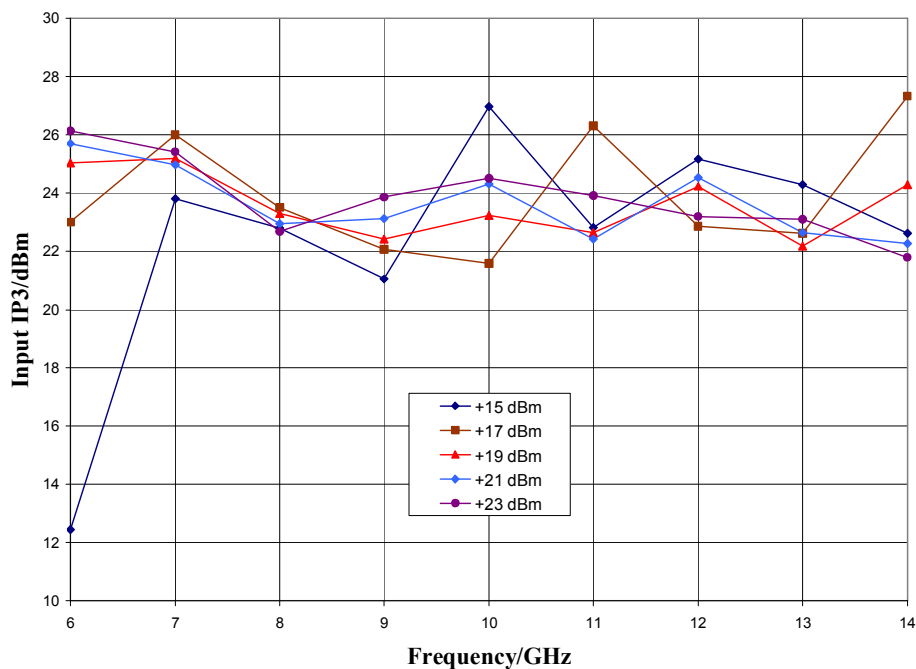

ver 1.0 1017

Typical Performance

Upconverter Performance, Input IP3 vs. LO Drive, IF = 100 MHz

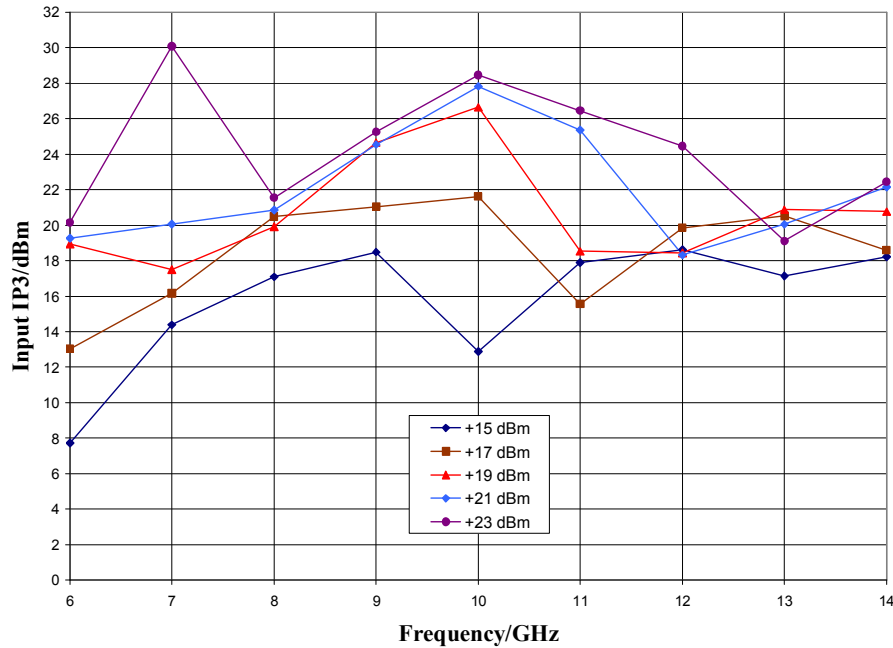

Input P1dB vs. Temperature, LO = +19 dBm, IF = 100 MHz USB

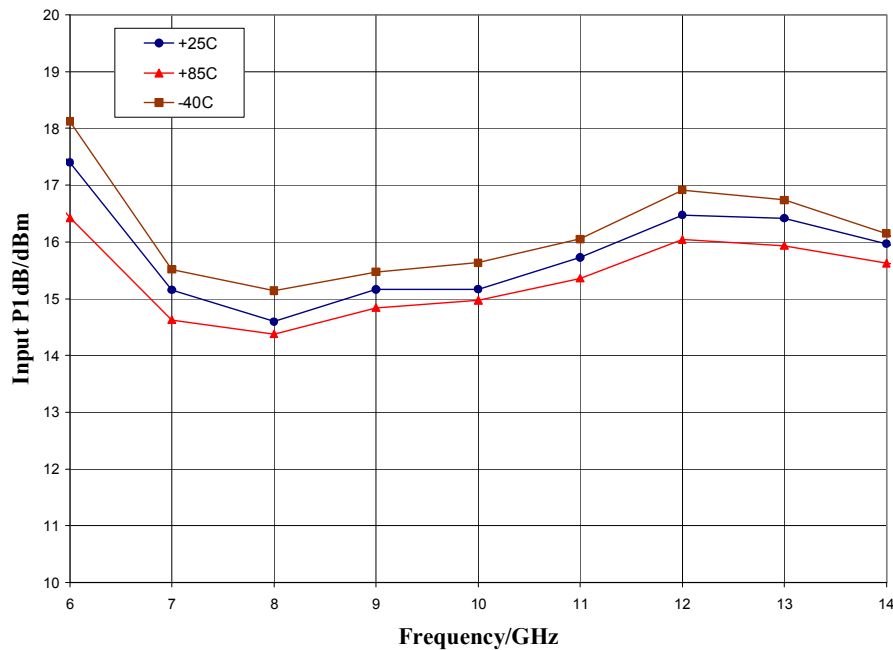

ver 1.0 1017

Typical Performance

MxN Spurious Outputs

	nLO				
mRF	0	1	2	3	4
0	xx	4	21	31	21
1	18	0	40	37	62
2	>64	>64	>64	>64	>64
3	>64	>64	>64	>64	>64
4		>64	>64	>64	>64

RF = 10.1 GHz @ -10 dBm
 LO = 10.0 GHz @ +19 dBm
 All values in dBc below the IF output power level (1RF - 1LO)

Mechanical Information

Package Information and Dimensions

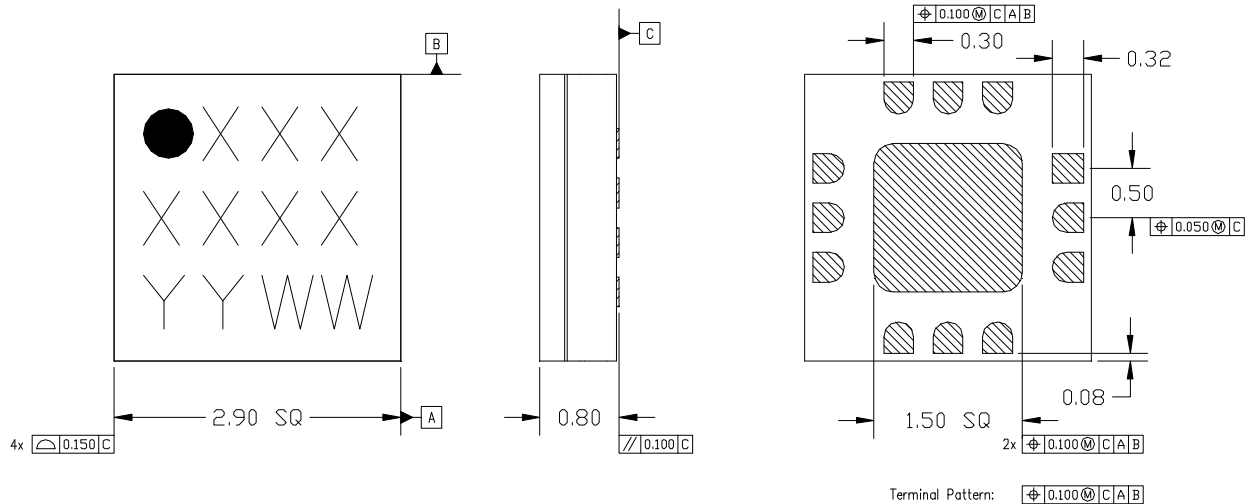

- NOTES:
1. ALL DIMENSIONS SHOWN IN mm.
 2. MATERIAL: BLACK ALUMINA
 3. LEAD FINISH:
 - 3.1. Ni: 8.89um MAX, 1.27um MIN
 - 3.2. Pd: 0.17um MAX, 0.07um MIN
 - 3.3. Au: 0.254um MAX, 0.03um MIN
 4. MARKING
 - 4.1. LINE 1: PART NUMBER
 - 4.1.1. EXAMPLE: CMD177C3 SHALL BE MARKED AS 177
 - 4.2. LINE 2: LDT NUMBER
 - 4.3. LINE 3: DATE CODE - LAST 2 DIGITS OF THE YEAR OF MANUFACTURE FOLLOWED BY A 2 DIGIT WEEK CODE
 5. ALTERNATE PIN #1 IDENTIFIER IS A SINGLE SQUARE PAD
 6. ALTERNATE DIE PADDLE MAY HAVE CHAMFERED CORNERS

Recommended PCB Land Pattern

Custom MMIC Design Services recommends that the user develop the land pattern that will provide the best design for proper solder reflow and device attach for their specific application. Please review Custom MMIC Application Note AN 105 for a recommended land pattern approach.

Recommended Solder Reflow Profile

Custom MMIC Design Services recommends screen printing with belt furnace reflow to ensure proper solder reflow and device attach. Please review Custom MMIC Application Note AN 102 for a recommended solder reflow profile.

Pin Description

Pin Diagram

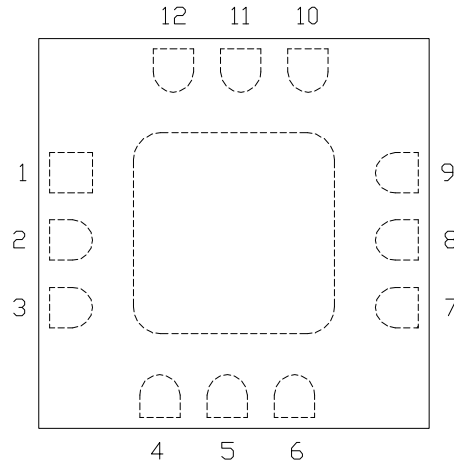

Functional Description

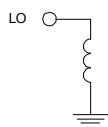
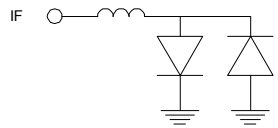
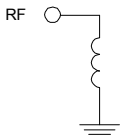
Pin	Function	Description	Schematic
1,3,4,6,7,9 and die paddle	Ground	Connect to RF / DC ground.	
2	LO	This pin is DC coupled and matched to 50 ohms.	
5	IF	This pin is DC coupled. For applications not requiring operation to DC, this port should be DC blocked externally using a series capacitor whose value has been chosen to pass the necessary IF frequency range. For operation to DC, this pin must not source or sink more than 16 mA of current or part non-function or part failure may result.	
8	RF	This pin is DC coupled and matched to 50 ohms.	
10-12	N/C	No connection required. These pins may be connected to RF/DC ground	

ver 1.0 1017

Applications Information

Evaluation Board

The circuit board shown has been developed for optimized assembly at Custom MMIC. A sufficient number of via holes should be used to connect the top and bottom ground planes. As surface mount processes vary, careful process development is recommended.

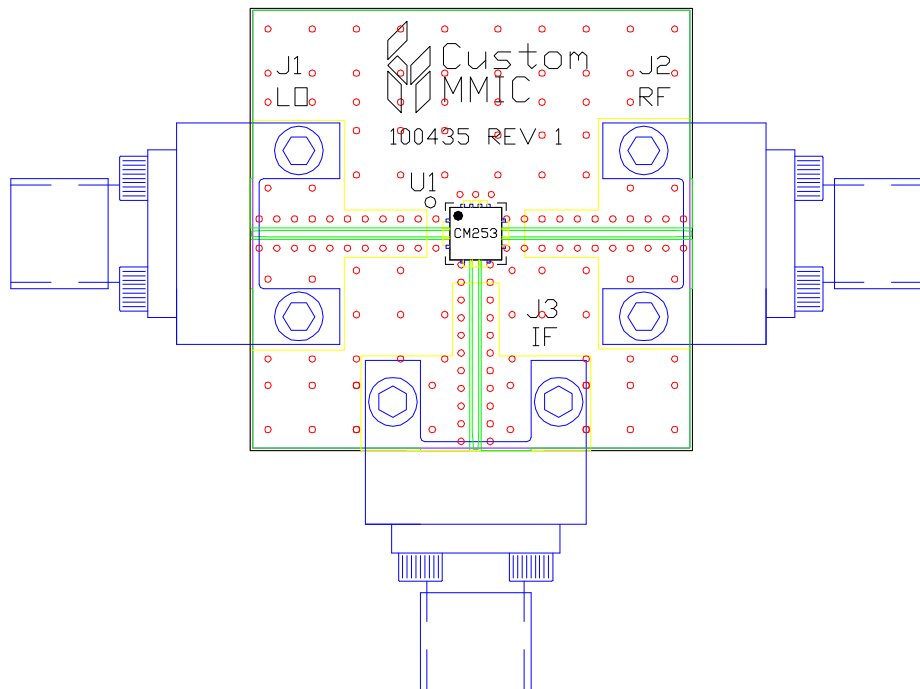

Bill of Material

Designator	Value	Description
J1 - J3		SMA End Launch Connector
U1		CMD253C3 Fundamental Mixer
PCB		100435 Evaluation PCB

GaAs MMIC devices are susceptible to damage from Electrostatic Discharge. Proper precautions should be observed during handling, assembly and test.

Please note, all information contained in this data sheet is subject to change without notice.

ver 1.0 1017