

Features

- ▶ Low conversion loss
- ▶ High isolation
- ▶ Image rejection: 30 dB
- ▶ Wide IF bandwidth
- ▶ Pb-free RoHs compliant 4x4 mm SMT package

Description

The CMD252C4 is a compact I/Q mixer in a leadless surface mount package that can be used as either an image reject mixer or a single sideband upconverter. The CMD252C4 utilizes two double balanced mixer cells and a 90 degree hybrid. An external IF hybrid is needed to complete the image rejection. The CMD252C4 is a much smaller alternative to higher cost hybrid image reject mixers and single sideband upconverter assemblies.

Functional Block Diagram

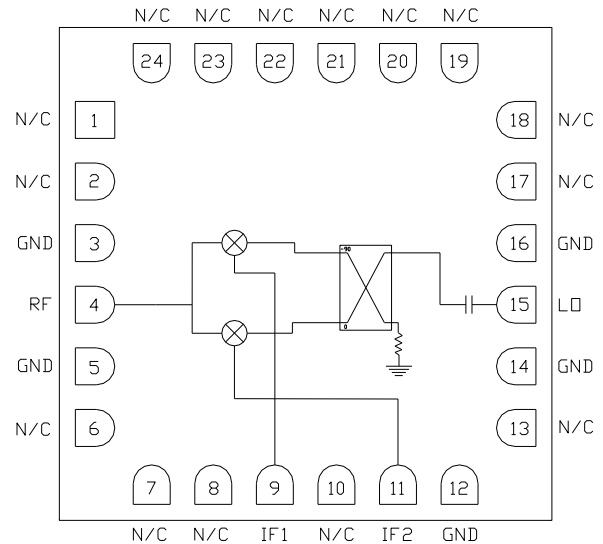

Electrical Performance – IF = 100 MHz, LO = +20 dBm, T_A = 25 °C, F = 6 GHz

Parameter	Min	Typ	Max	Units
Frequency Range, RF & LO	4 – 8			GHz
Frequency Range, IF	DC		2.4	GHz
Conversion Loss (as IRM)		6.5		dB
Image Rejection		30		dB
LO to RF Isolation		52		dB
LO to IF Isolation		27		dB
Input IP3		25		dBm

Unless otherwise noted, all measurements performed as a downconverter, IF = 100 MHz

Specifications

Absolute Maximum Ratings

Parameter	Rating
RF / IF Input Power	+25 dBm
LO Drive	+25 dBm
Operating Temperature	-40 to 85 °C
Storage Temperature	-55 to 150 °C
Thermal resistance, Θ_{JC}	70.9 °C / W

Operation of this device outside the maximum ratings may cause permanent damage.

Electrical Specifications – IF = 100 MHz, LO = +20 dBm, T_A = 25 °C

Parameter	Min	Typ	Max	Min	Typ	Max	Units
Frequency Range, RF & LO	4 – 7			7 – 8			GHz
Frequency Range, IF	DC		2.4	DC		2.4	GHz
Conversion Loss (as IRM)		7	9		8.5	10	dB
Image Rejection	20	25		15	18		dB
LO to RF Isolation	40	50		50	55		dB
LO to IF Isolation	16	25		22	30		dB
Input P1dB		15			17		dBm
Input IP3		25			26		dBm

Unless otherwise noted, all measurements performed as a downconverter, IF = 100 MHz

Typical Performance

Data Taken As IRM With External IF Hybrid

Conversion Gain vs. Temperature, LO = +20 dBm, IF = 100 MHz USB

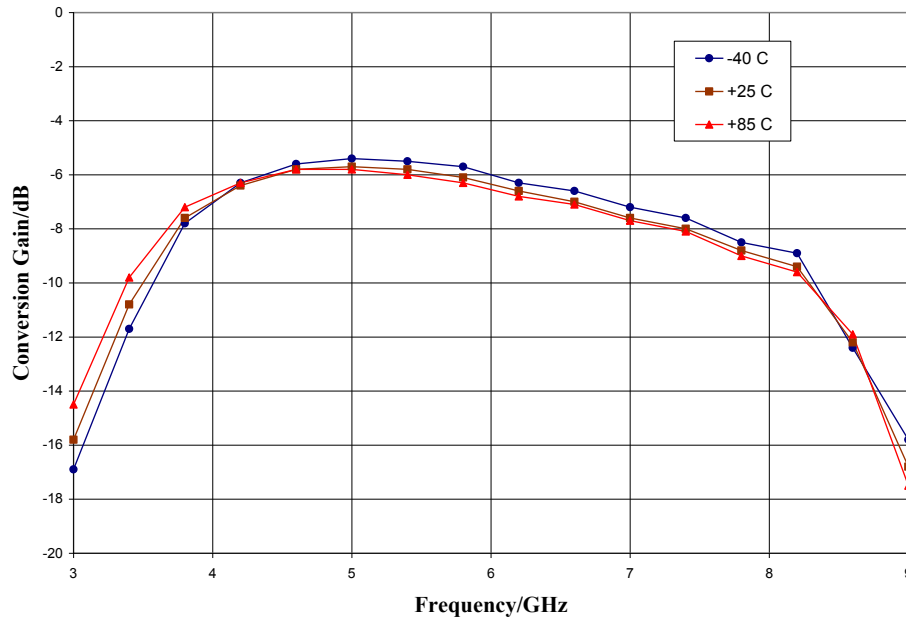

Conversion Gain vs. LO Drive, IF = 100 MHz USB

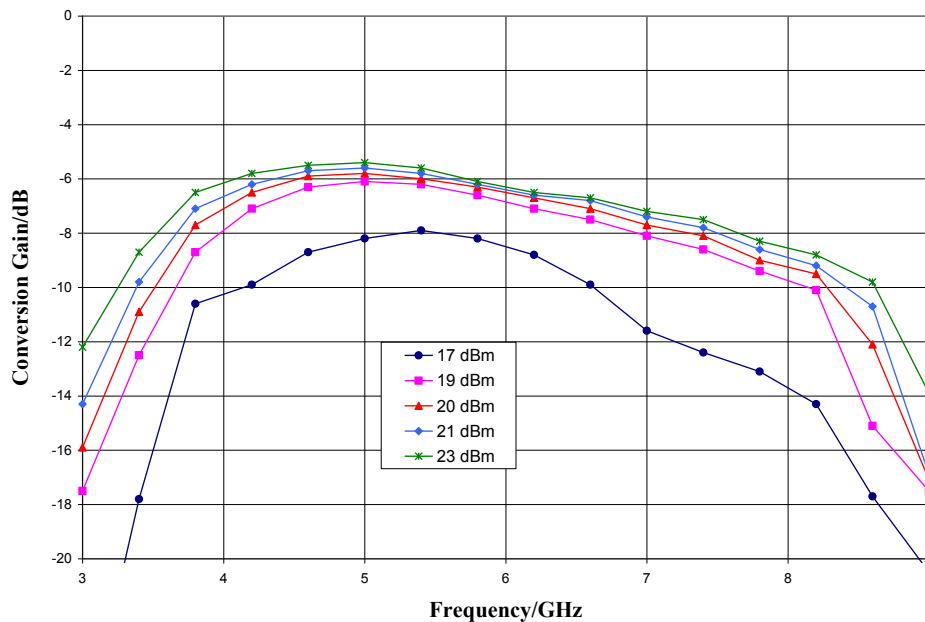

ver 1.0 0717

Typical Performance

Data Taken As IRM With External IF Hybrid

Image Rejection, LO = +20 dBm, IF = 100 MHz USB

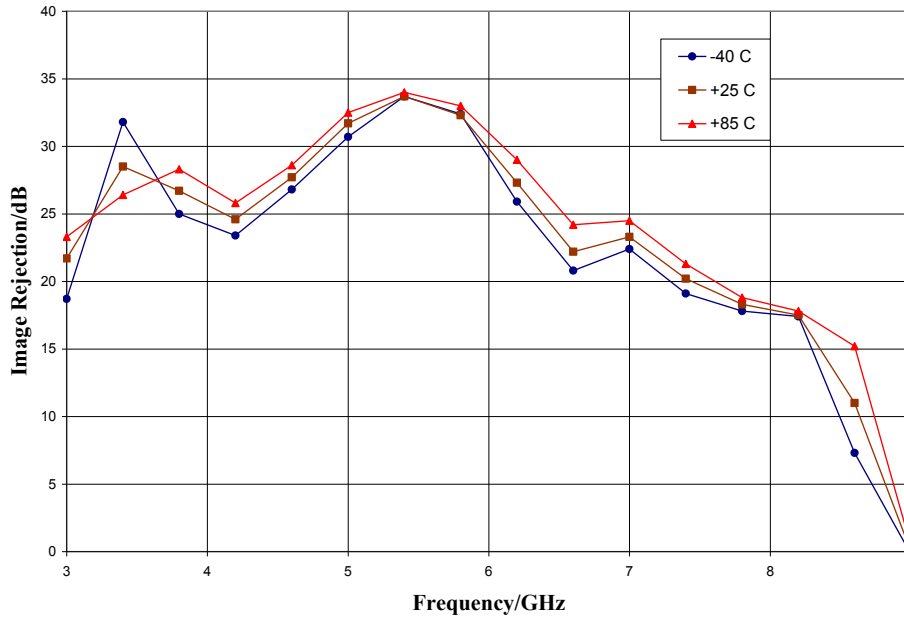

Return Loss, LO = +20 dBm

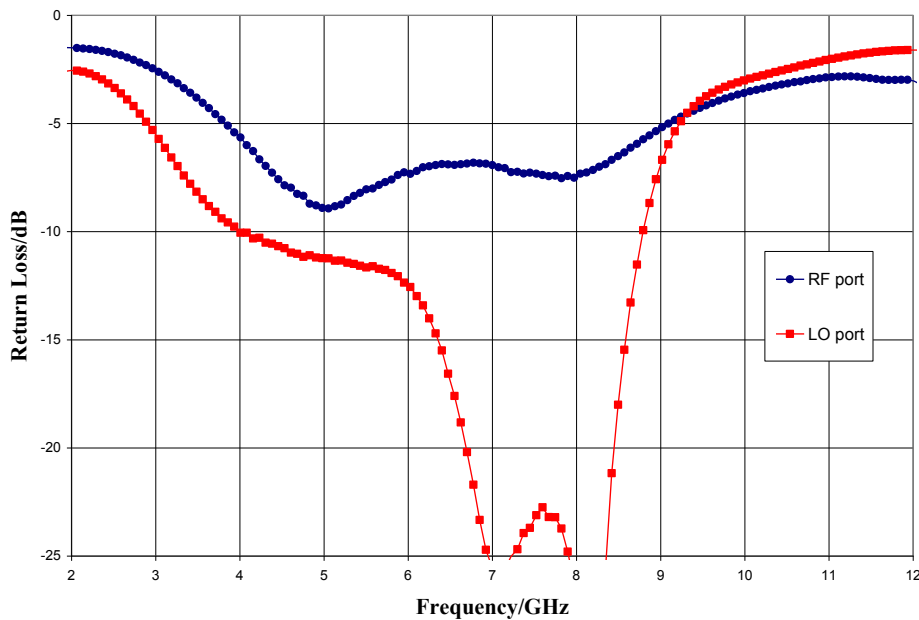

ver 1.0 0717

Typical Performance

Data Taken As IRM With External IF Hybrid

Input P1dB vs. Temperature, LO = +20 dBm, IF = 100 MHz USB

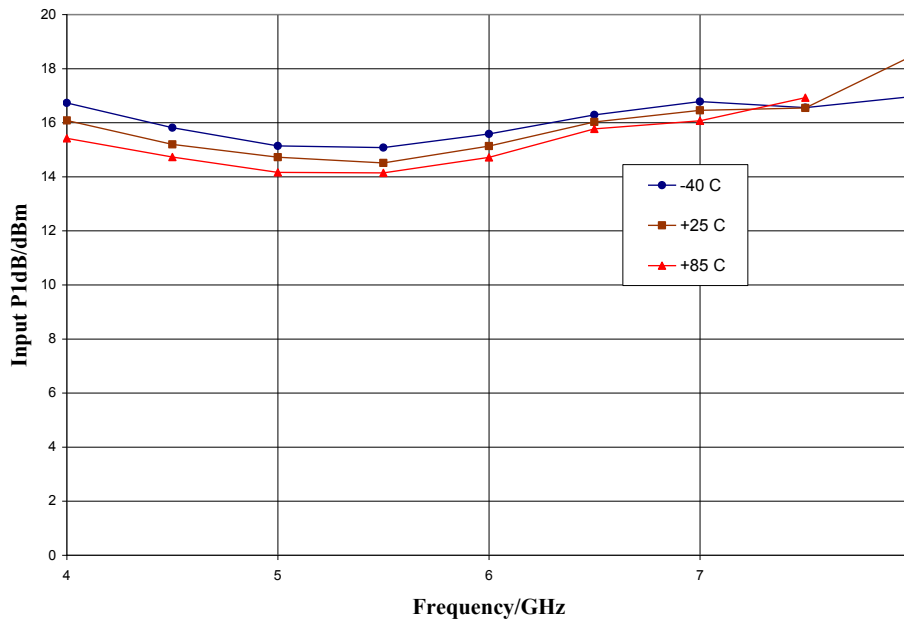

Input IP3 vs. Temperature, LO = +20 dBm, IF = 100 MHz USB

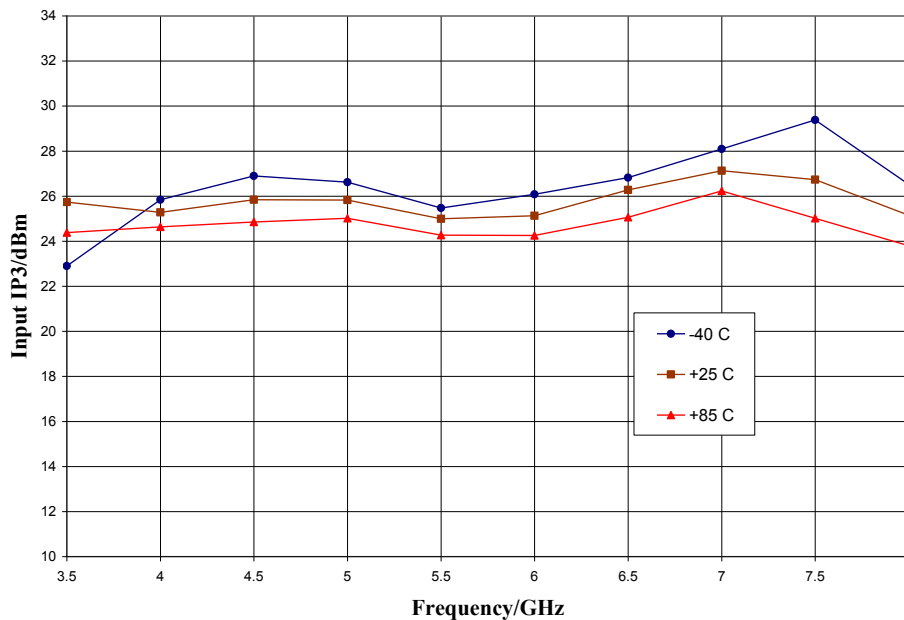

ver 1.0 0717

Typical Performance

Data Taken As IRM With External IF Hybrid

Input IP3 vs. LO Drive, IF = 100 MHz USB

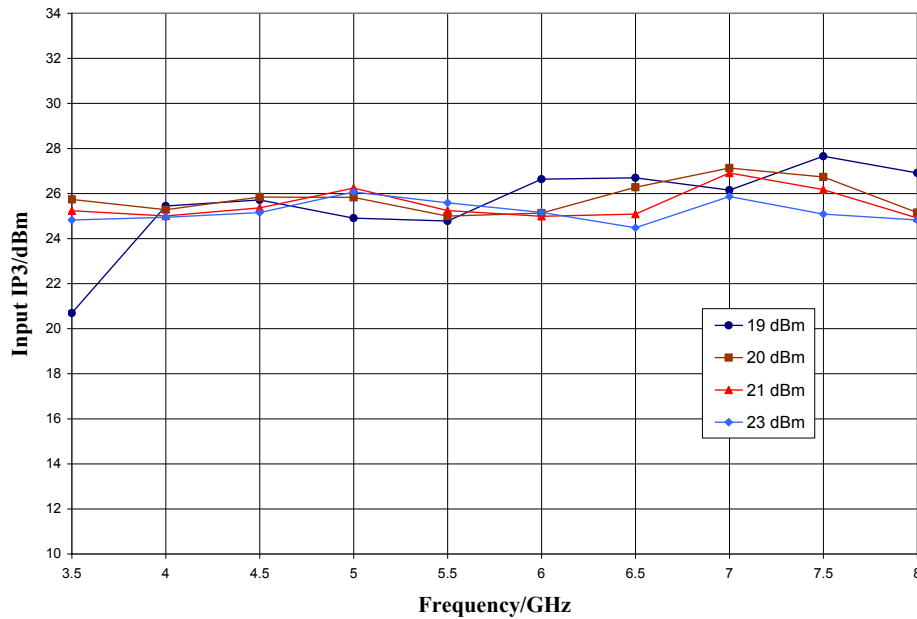

Upconverter Performance, Conversion Gain vs. LO Drive, IF = 100 MHz

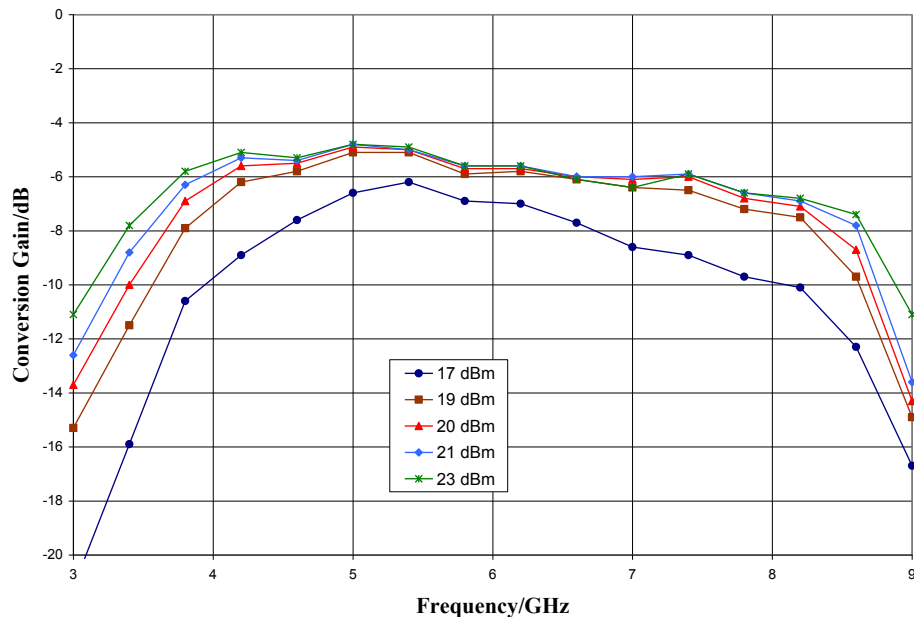

ver 1.0 0717

Typical Performance

Data Taken As IRM With External IF Hybrid

Upconverter Performance, Input IP3 vs. LO Drive, IF = 500 MHz

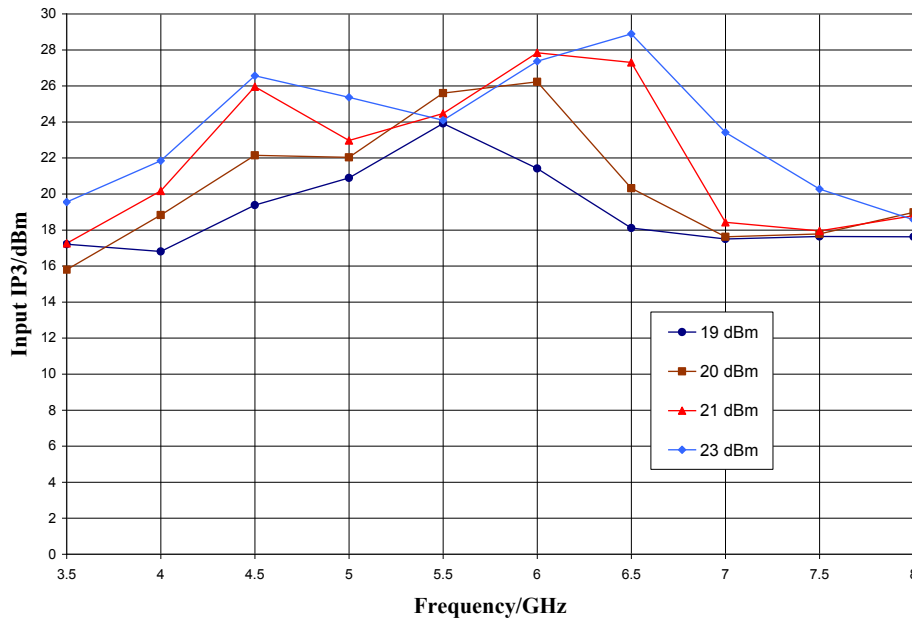

IF Bandwidth, LO = +20 dBm, Return Loss Data Taken Without IF Hybrid

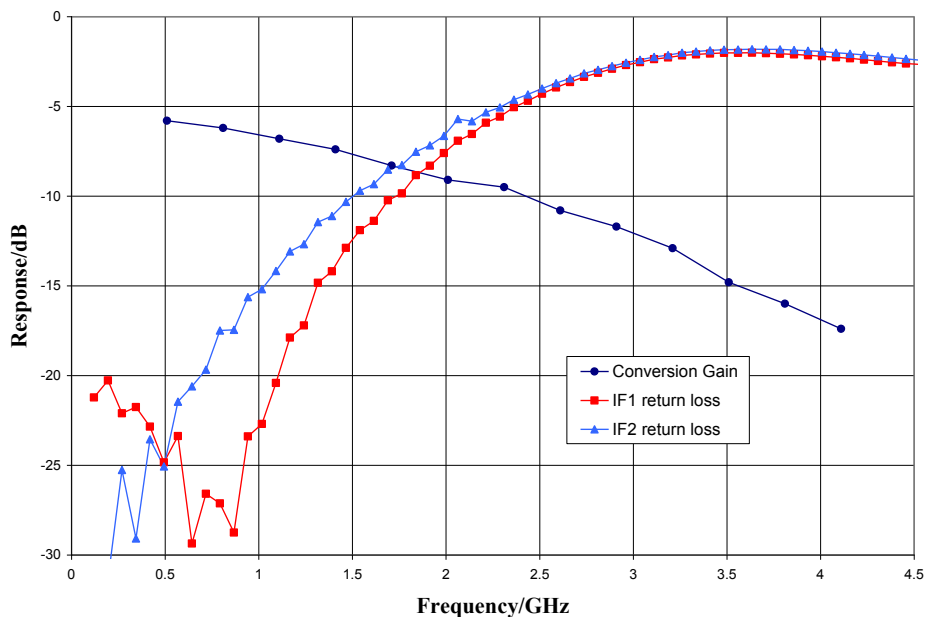

ver 1.0 0717

Typical Performance

Isolations, LO = +20 dBm. Data Taken Without IF Hybrid

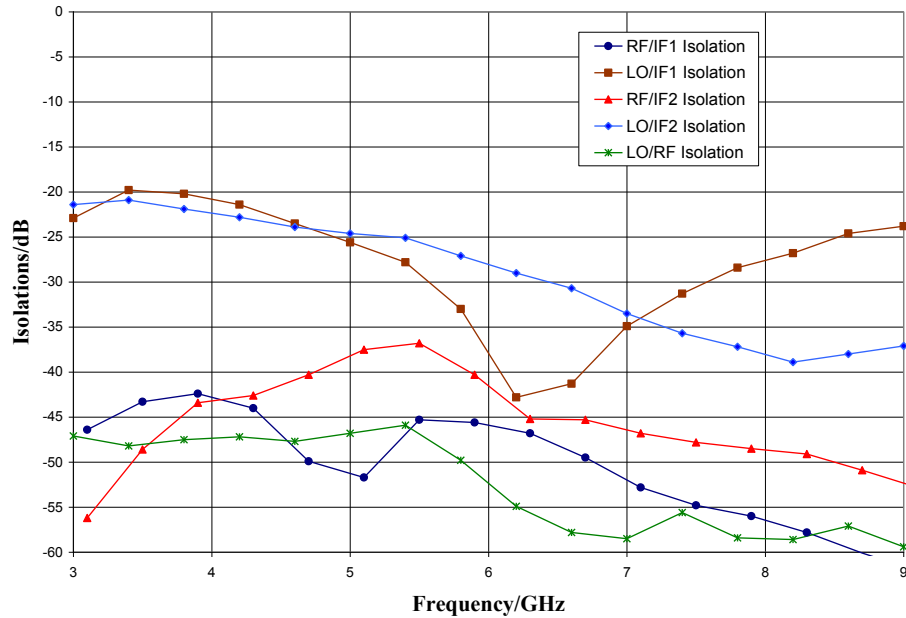

MxN Spurious Outputs to IF1, IF2

	nLO				
mRF	0	1	2	3	4
0	xx	-1 / -10	36 / 30	10 / 14	50 / 61
1	38 / 38	0	42 / 44	50 / 48	62 / 64
2	> 80	65 / 62	69 / > 80	> 80 / 66	> 80
3	> 80	> 80	> 80	> 80	68 / > 80
4	> 80	> 80	> 80	> 80	> 80

RF = 6.1 GHz @ -10 dBm

LO = 6.0 GHz @ +20 dBm

All values in dBc below the IF1 / IF2 output power level (1RF - 1LO)

Measurement performed without IF hybrid

Where two numbers are listed, they are the spur levels for the IF1 / IF2 ports

ver 1.0 0717

Mechanical Information

Package Information and Dimensions

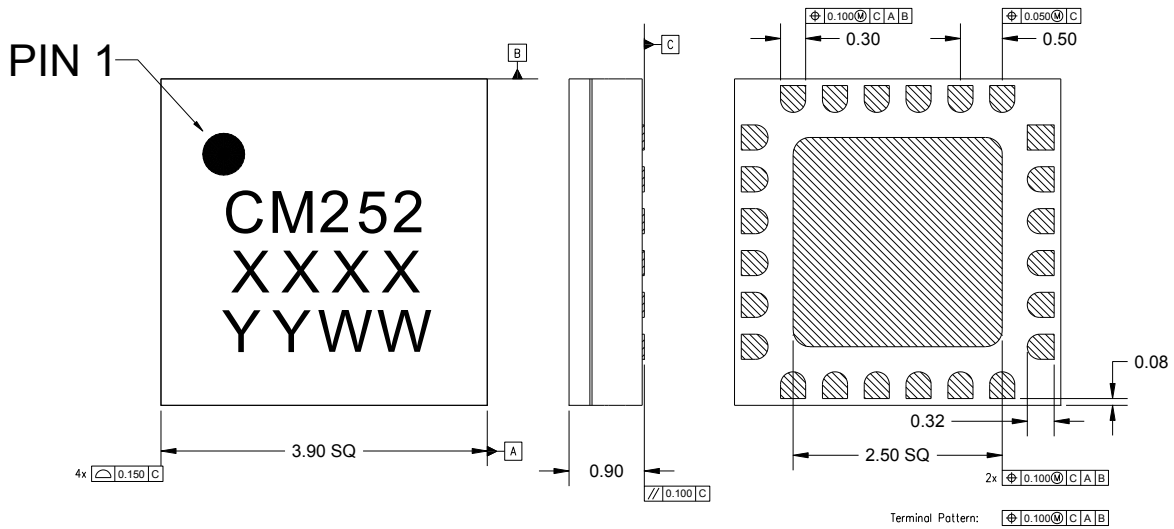

NOTES:

1. ALL DIMENSIONS SHOWN IN mm.
2. MATERIAL: BLACK ALUMINA
3. LEAD FINISH:
 - 3.1. Ni: 8.89um MAX, 1.27um MIN
 - 3.2. Pd: 0.17um MAX, 0.07um MIN
 - 3.3. Au: 0.254um MAX, 0.03um MIN
4. MARKING: ALL MARKING SHALL BE PERMANENT AND LEGIBLE
5. ALTERNATE PIN #1 IDENTIFIER IS A SINGLE SQUARE PAD

Recommended PCB Land Pattern

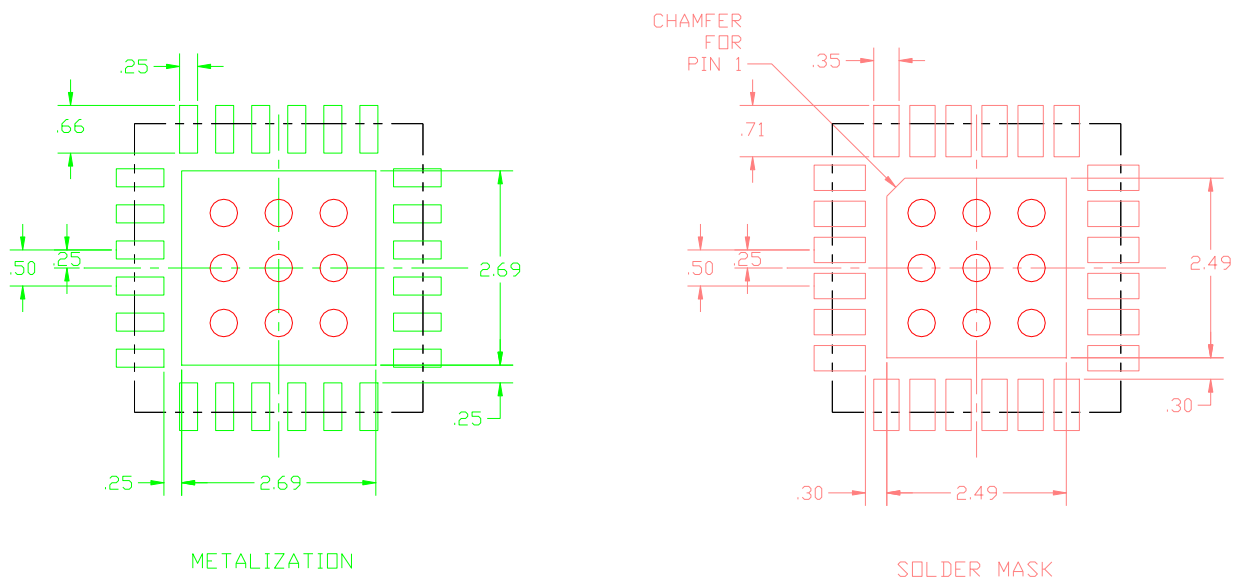



ver 1.0 0717

Pin Description

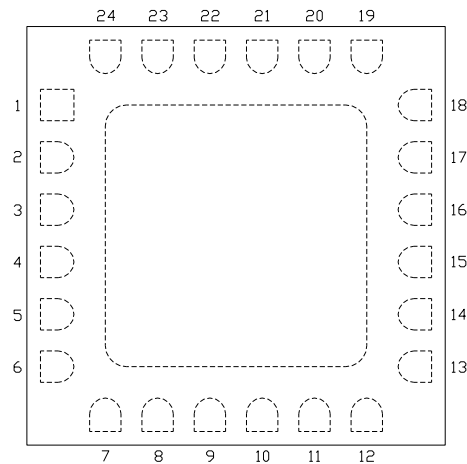
Pin Diagram

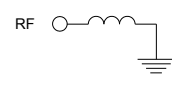
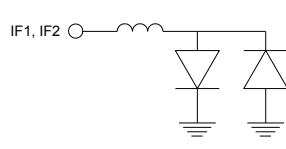

Functional Description

Pin	Function	Description	Schematic
1, 2, 6-8, 10, 13, 17-24	N/C	No connection required. These pins may be connected to RF/DC ground.	
3, 5, 12, 14, 16 and die paddle	Ground	Connect to RF / DC ground.	
4	RF	This pin is DC coupled and matched to 50 ohms.	
9	IF1	This pin is DC coupled. For applications not requiring operation to DC, this port should be DC blocked externally using a series capacitor whose value has been chosen to pass the necessary IF frequency range. For operation to DC, this pin must not source or sink more than 16 mA of current or part non-function or part failure may result.	
11	IF2		
15	LO	This pin is AC coupled and matched to 50 ohms.	

ver 1.0 0717

Applications Information

Evaluation Board

The circuit board shown has been developed for optimized assembly at Custom MMIC. A sufficient number of via holes should be used to connect the top and bottom ground planes. As surface mount processes vary, careful process development is recommended.

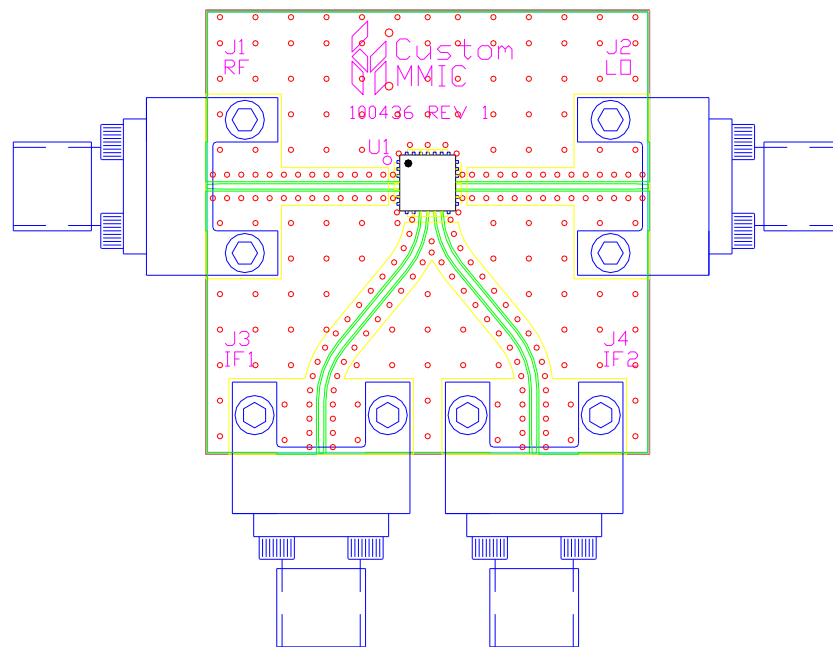
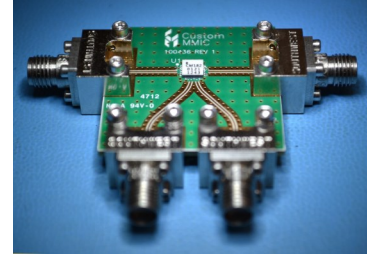

Bill of Material

Designator	Value	Description
J1 - J4		SMA End Launch Connector
U1		CMD252C4 I/Q Mixer
PCB		100436 Evaluation PCB

GaAs MMIC devices are susceptible to damage from Electrostatic Discharge. Proper precautions should be observed during handling, assembly and test.

Please note, all information contained in this data sheet is subject to change without notice.

ver 1.0 0717