

Features

- ▶ Wide bandwidth
- ▶ High gain
- ▶ Low noise and high linearity
- ▶ Excellent return losses
- ▶ Small die size

Description

The CMD243 is a wideband GaAs MMIC driver amplifier ideally suited for military, space and communications systems where small size and high linearity are needed. At 30 GHz the device delivers 15.5 dB of gain with a corresponding output 1 dB compression point of +21 dBm and noise figure of 4.4 dB. The CMD243 is a 50 ohm matched design which eliminates the need for external DC blocks and RF port matching. The CMD243 offers full passivation for increased reliability and moisture protection.

Functional Block Diagram

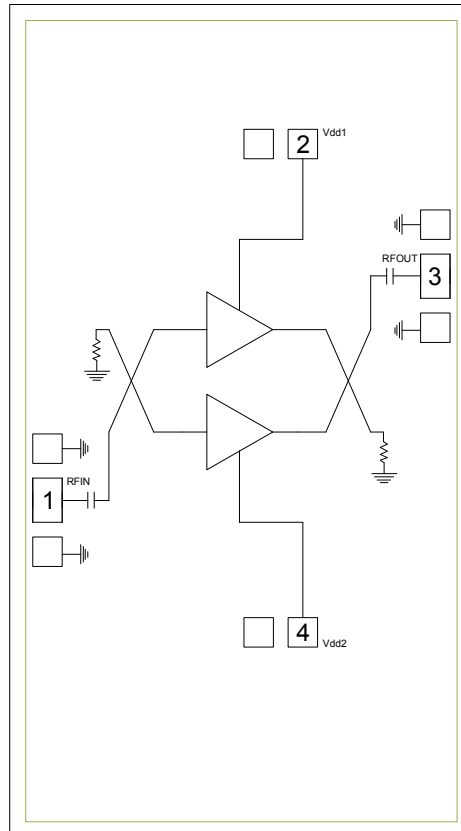

Electrical Performance - $V_{dd1} = V_{dd2} = 5.0$ V, $T_A = 25$ °C, $F = 30$ GHz

Parameter	Min	Typ	Max	Units
Frequency Range	26 - 35			GHz
Gain		15.5		dB
Noise Figure		4.4		dB
Input Return Loss		11		dB
Output Return Loss		11		dB
Output P1dB		21		dBm
Supply Current ($I_{dd1} + I_{dd2}$)		90		mA

ver 1.3 1018

Specifications

Absolute Maximum Ratings

Parameter	Rating
Drain Voltage, V _{dd1} , V _{dd2}	8 V
RF Input Power	+20 dBm
Channel Temperature, T _{ch}	150 °C
Power Dissipation, P _{diss}	694 mW
Thermal Resistance, Θ_{JC}	93.7 °C/W
Operating Temperature	-55 to 85 °C
Storage Temperature	-55 to 150 °C

Exceeding any one or combination of the maximum ratings may cause permanent damage to the device.

Recommended Operating Conditions

Parameter	Min	Typ	Max	Units
V _{dd1} , V _{dd2}	3.0	5.0	7.0	V
I _{dd1}		45		mA
I _{dd2}		45		mA

Electrical performance is measured at specific test conditions. Electrical specifications are not guaranteed over all recommended operating conditions.

Electrical Specifications, V_{dd1} = V_{dd2} = 5.0 V, T_A = 25 °C

Parameter	Min	Typ	Max	Units
Frequency Range	26 - 35			GHz
Gain	12.5	15.5		dB
Noise Figure		4.5		dB
Input Return Loss		11		dB
Output Return Loss		11		dB
Output P _{1dB}	18	21		dBm
Output IP ₃		25		dBm
Supply Current (I _{dd1} + I _{dd2})	60	90	120	mA
Gain Temperature Coefficient		0.02		dB/°C
Noise Figure Temperature Coefficient		0.015		dB/°C

ver 1.3 1018

Typical Performance

Broadband Performance, $V_{dd1} = V_{dd2} = 5.0$ V, $I_{dd1} = I_{dd2} = 45$ mA, $T_A = 25$ °C

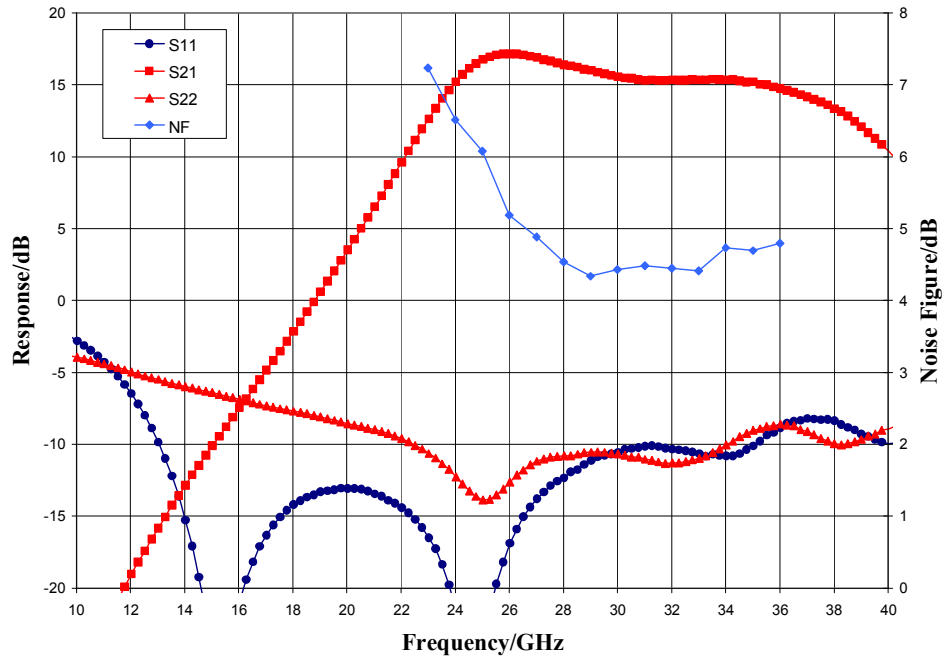

Narrow-band Performance, $V_{dd1} = V_{dd2} = 5.0$ V, $I_{dd1} = I_{dd2} = 45$ mA, $T_A = 25$ °C

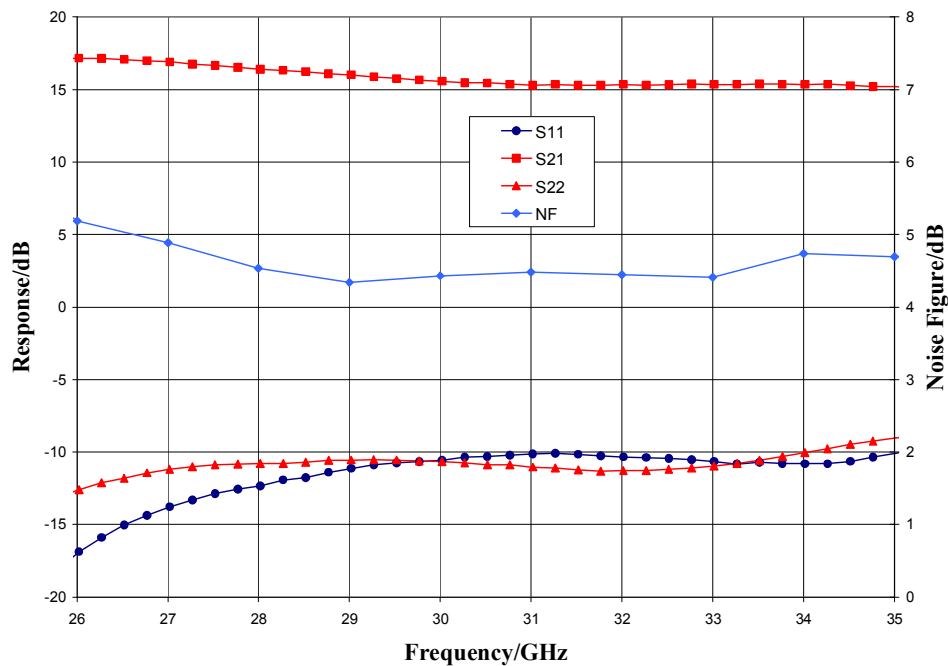

ver 1.3 1018

Typical Performance

Gain vs. Temperature, $V_{dd1} = V_{dd2} = 5.0\text{ V}$

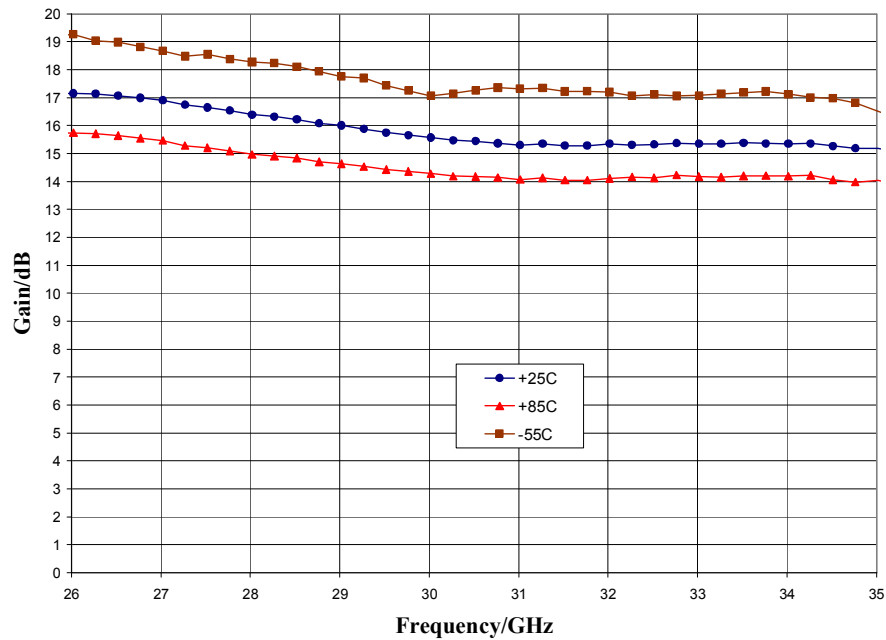

Noise Figure vs. Temperature, $V_{dd1} = V_{dd2} = 5.0\text{ V}$

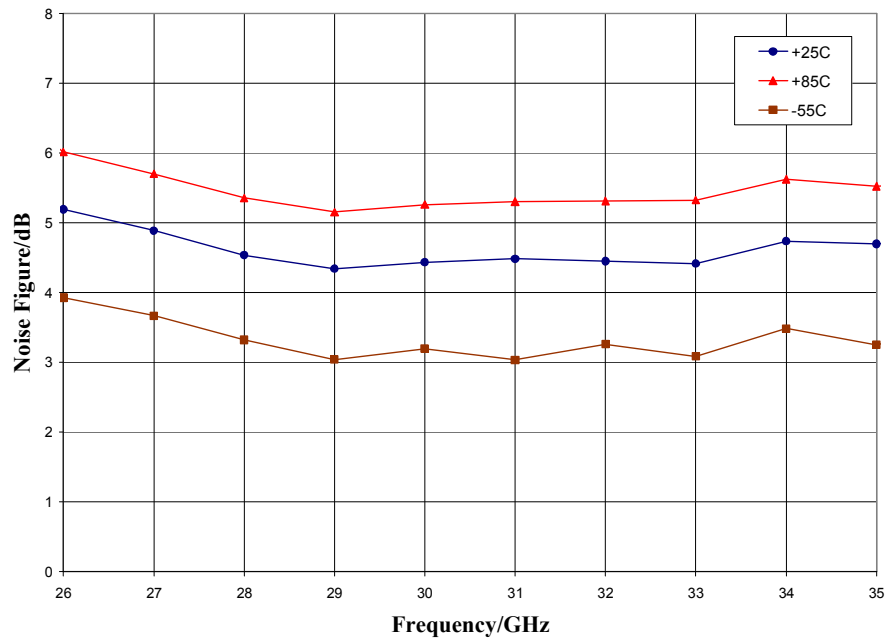

Typical Performance

Output Power, $V_{dd1} = V_{dd2} = 5.0\text{ V}$, $T_A = 25\text{ }^\circ\text{C}$

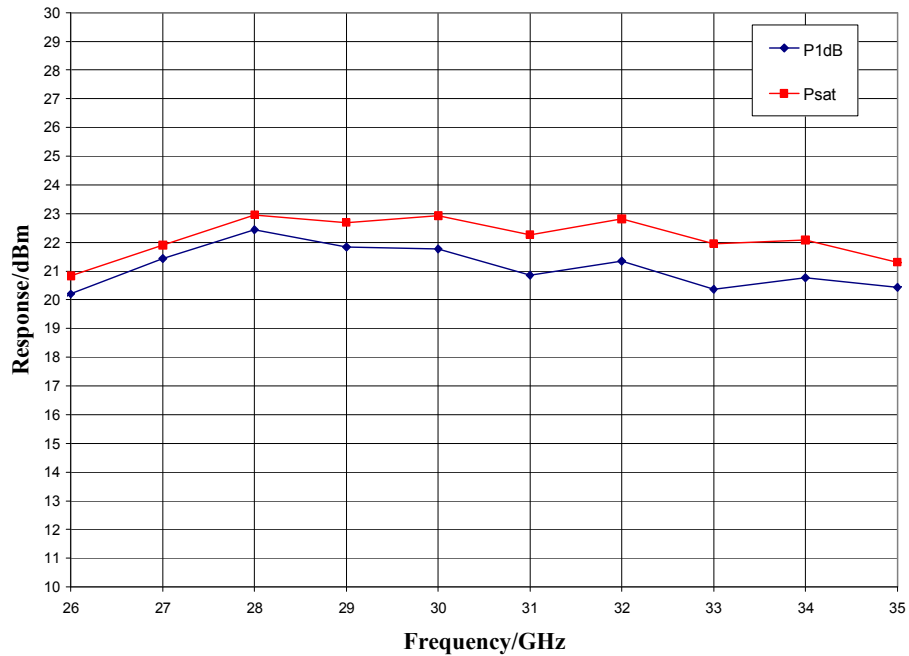

P1dB vs. Temperature, $V_{dd1} = V_{dd2} = 5.0\text{ V}$

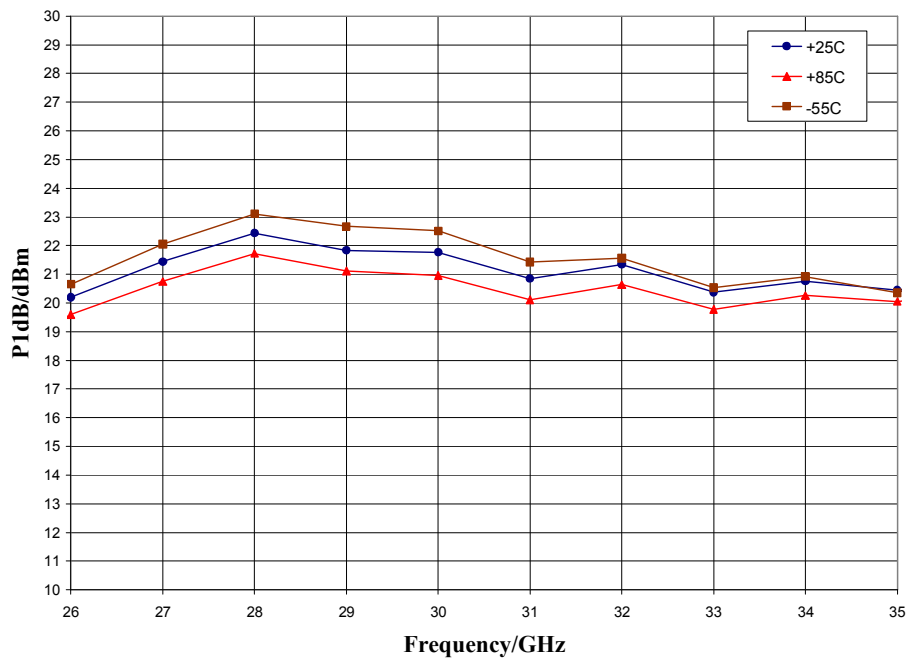

ver 1.3 1018

Typical Performance

Output IP3 vs. Temperature, $V_{dd1} = V_{dd2} = 5.0$ V

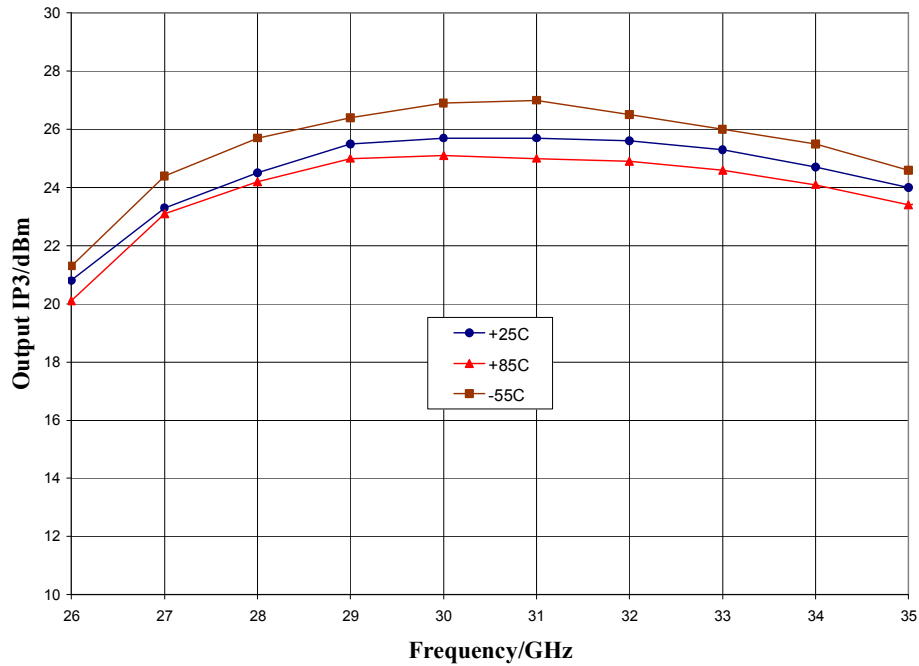

Mechanical Information

Die Outline (all dimensions in microns)

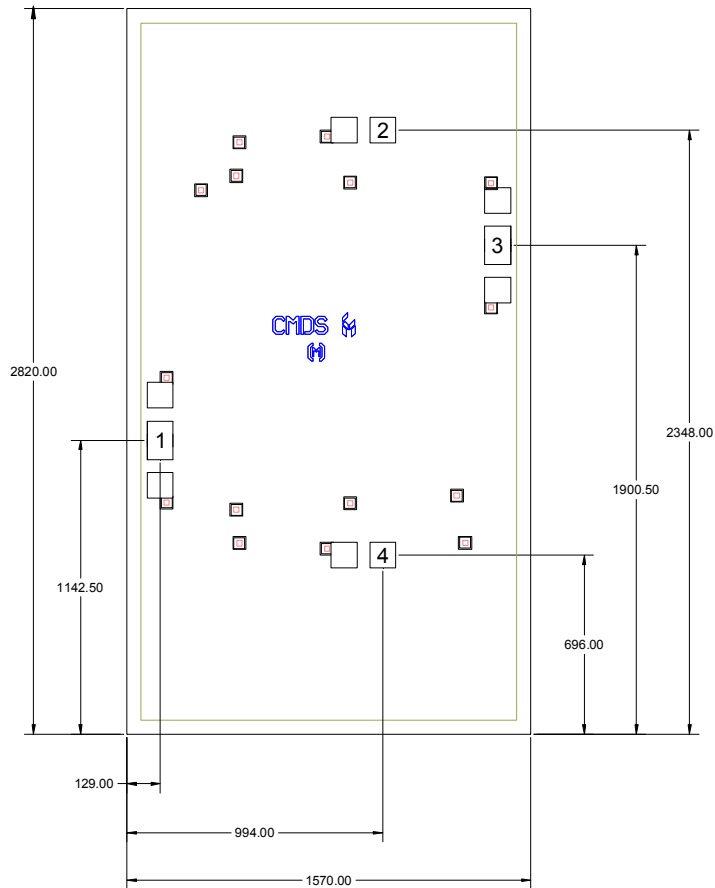

Notes:



1. No connection required for unlabeled pads
2. Backside is RF and DC ground
3. Backside and bond pad metal: Gold
4. Die is 70 microns thick
5. DC bond pads (2, 4) are 100 x 100 microns
6. RF bond pads (1, 3) are 100 x 150 microns

Pad Description

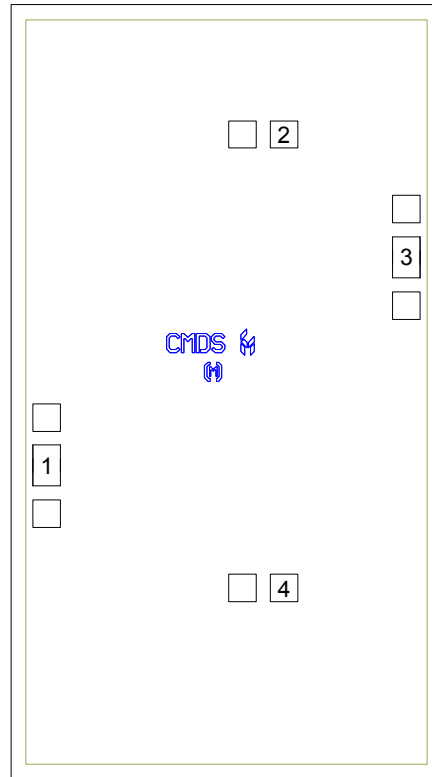
Pad Diagram

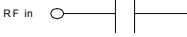
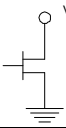

Functional Description

Pad	Function	Description	Schematic
1	RF in	DC blocked and 50 ohm matched	
2, 4	Vdd1, Vdd2	Power supply voltage Decoupling and bypass caps required	
3	RF out	DC blocked and 50 ohm matched	
Backside	Ground	Connect to RF / DC ground	

ver 1.3 1018

Applications Information

Assembly Guidelines

The backside of the CMD243 is RF ground. Die attach should be accomplished with electrically and thermally conductive epoxy or eutectic attach. Standard assembly procedures should be followed for high frequency devices. The top surface of the semiconductor should be made planar to the adjacent RF transmission lines, and the RF decoupling capacitors placed in close proximity to the DC connections on chip.

RF connections should be made as short as possible to reduce the inductive effect of the bond wire. Use of a 0.8 mil thermosonic wedge bonding is highly recommended as the loop height will be minimized. The RF input and output require a double bond wire as shown.

The semiconductor is 70 um thick and should be handled by the sides of the die or with a custom collet. Do not make contact directly with the die surface as this will damage the monolithic circuitry. Handle with care.

Assembly Diagram

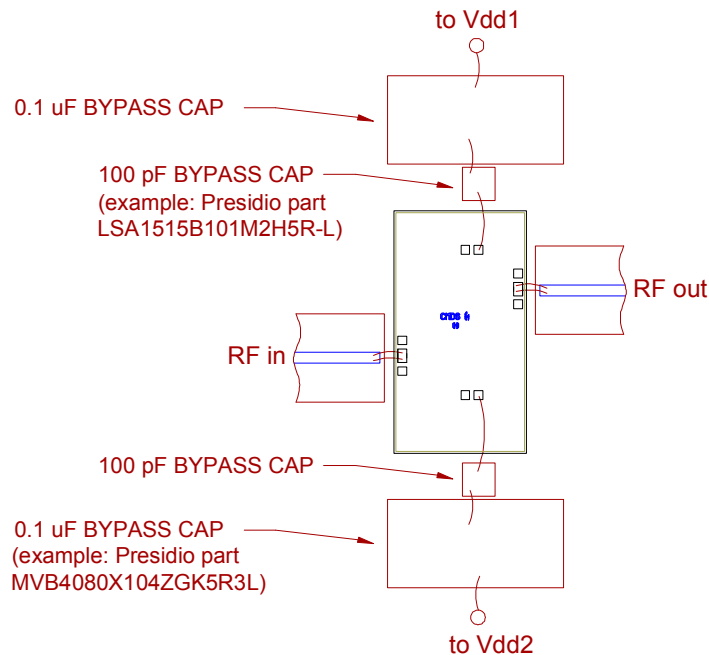

GaAs MMIC devices are susceptible to damage from Electrostatic Discharge. Proper precautions should be observed during handling, assembly and test.

Applications Information

Biasing and Operation

The CMD243 is biased with a positive drain supply. Performance is optimized when the drain voltage is set to +5.0 V.

Turn ON procedure:

1. Apply drain voltage V_{dd1} , V_{dd2} and set to +5 V

Turn OFF procedure:

1. Turn off drain voltage V_{dd1} , V_{dd2}

RF power can be applied at any time.