

Features

- ▶ Ultra wideband performance
- ▶ Low noise figure
- ▶ Low current consumption
- ▶ Excellent return losses
- ▶ Small die size

Description

The CMD241 is wideband GaAs MMIC distributed low noise amplifier die which operates from 2 to 22 GHz. The amplifier delivers 14 dB of gain with a corresponding noise figure of 2.3 dB and an output 1 dB compression point of +21 dBm at 11 GHz. The CMD241 is a 50 ohm matched design which eliminates the need for external DC blocks and RF port matching. The CMD241 offers full passivation for increased reliability and moisture protection.

Functional Block Diagram

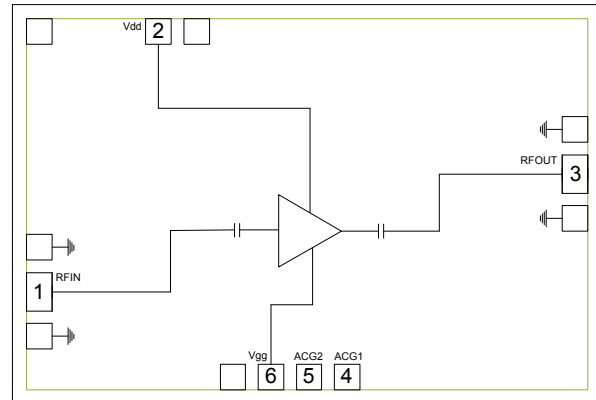

Electrical Performance - $V_{dd} = 5.0\text{ V}$, $V_{gg} = -0.65\text{ V}$, $T_A = 25\text{ }^\circ\text{C}$, $F = 11\text{ GHz}$

Parameter	Min	Typ	Max	Units
Frequency Range	2 - 22			GHz
Gain		14		dB
Noise Figure		2.3		dB
Input Return Loss		20		dB
Output Return Loss		17		dB
Output P1dB		21		dBm
Output IP3		28		dBm
Supply Current		74		mA

Specifications

Absolute Maximum Ratings

Parameter	Rating
Drain Voltage, V _{dd}	10 V
Gate Voltage, V _{gg}	-2.5 to 0 V
RF Input Power	+20 dBm
Channel Temperature, T _{ch}	150 °C
Power Dissipation, P _{diss}	1.75 W
Thermal Resistance, Θ_{JC}	37 °C/W
Operating Temperature	-55 to 85 °C
Storage Temperature	-55 to 150 °C

Exceeding any one or combination of the maximum ratings may cause permanent damage to the device.

Recommended Operating Conditions

Parameter	Min	Typ	Max	Units
V _{dd}	5.0	5.0	8.0	V
I _{dd}		74		mA
V _{gg}		-0.65		V

Electrical performance is measured at specific test conditions. Electrical specifications are not guaranteed over all recommended operating conditions.

Electrical Specifications, V_{dd} = 5.0 V, V_{gg} = -0.65 V, T_A = 25 °C

Parameter	Min	Typ	Max	Min	Typ	Max	Min	Typ	Max	Units
Frequency Range	2 - 6			6 - 18			18 - 22			GHz
Gain	11	14		10.5	13.5		11	15		dB
Noise Figure		3.5			2.5			3.75		dB
Input Return Loss		13			13			15		dB
Output Return Loss		15			14			10		dB
Output P _{1dB}	16	20		14	18		14	17		dBm
Output IP ₃		29			28			25		dBm
Supply Current	50	74	100	50	74	100	50	74	100	mA
Gain Temperature Coefficient		0.004			0.006			0.007		dB/°C
Noise Figure Temperature Coefficient		0.01			0.009			0.014		dB/°C

ver 1.5 1018

Typical Performance

Broadband Performance, $V_{dd} = 5.0$ V, $V_{gg} = -0.65$ V, $I_{dd} = 74$ mA, $T_A = 25$

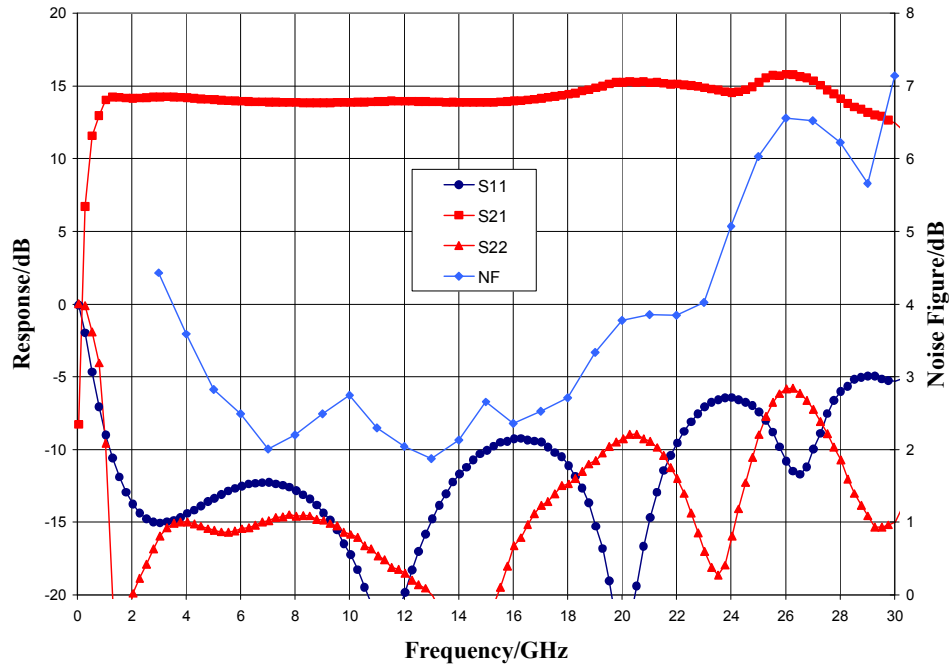

Narrow-band Performance, $V_{dd} = 5.0$ V, $V_{gg} = -0.65$ V, $I_{dd} = 74$ mA, $T_A = 25$

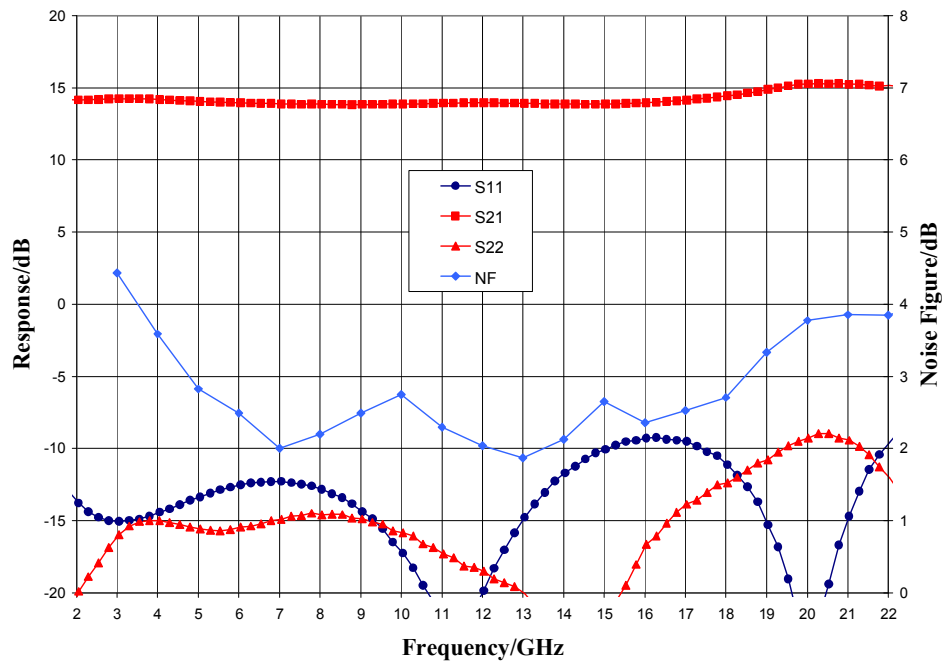

ver 1.5 1018

Typical Performance

Gain vs. Temperature, $V_{dd} = 5.0\text{ V}$, $V_{gg} = -0.65\text{ V}$

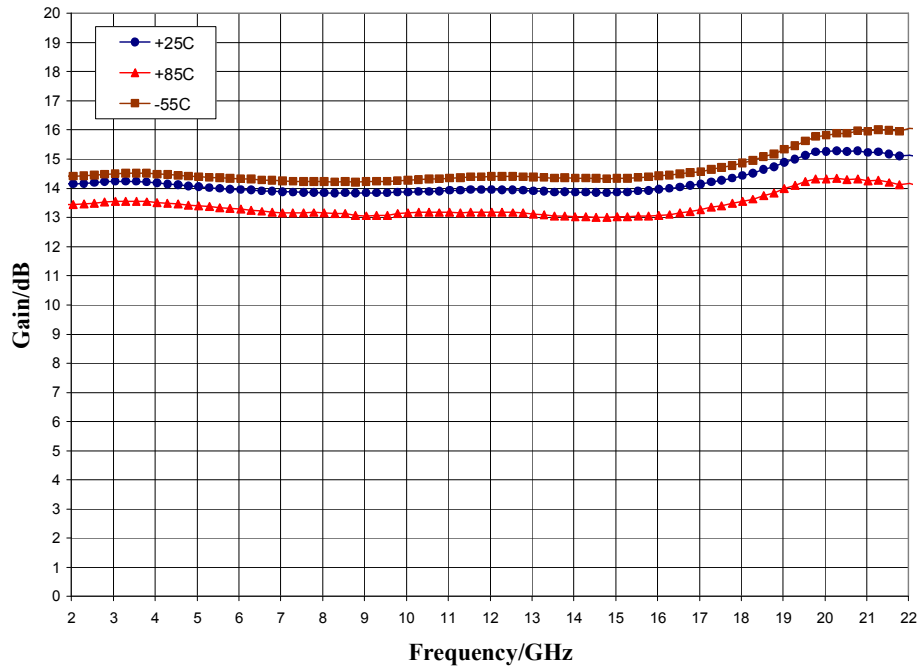

Noise Figure vs. Temperature, $V_{dd} = 5.0\text{ V}$, $V_{gg} = -0.65\text{ V}$

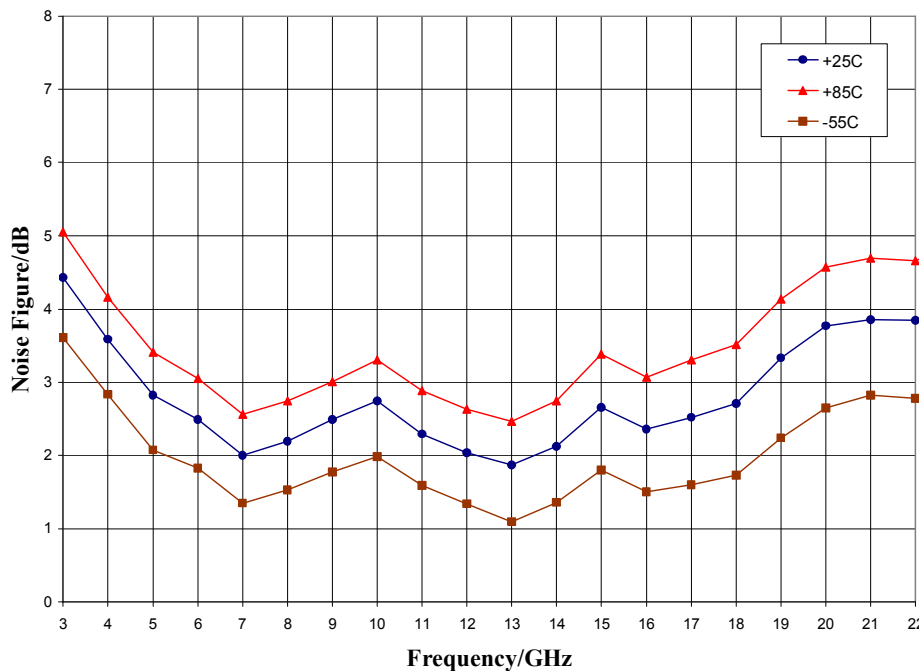

ver 1.5 1018

Typical Performance

Output Power, $V_{dd} = 5.0\text{ V}$, $V_{gg} = -0.65\text{ V}$, $T_A = 25\text{ }^\circ\text{C}$

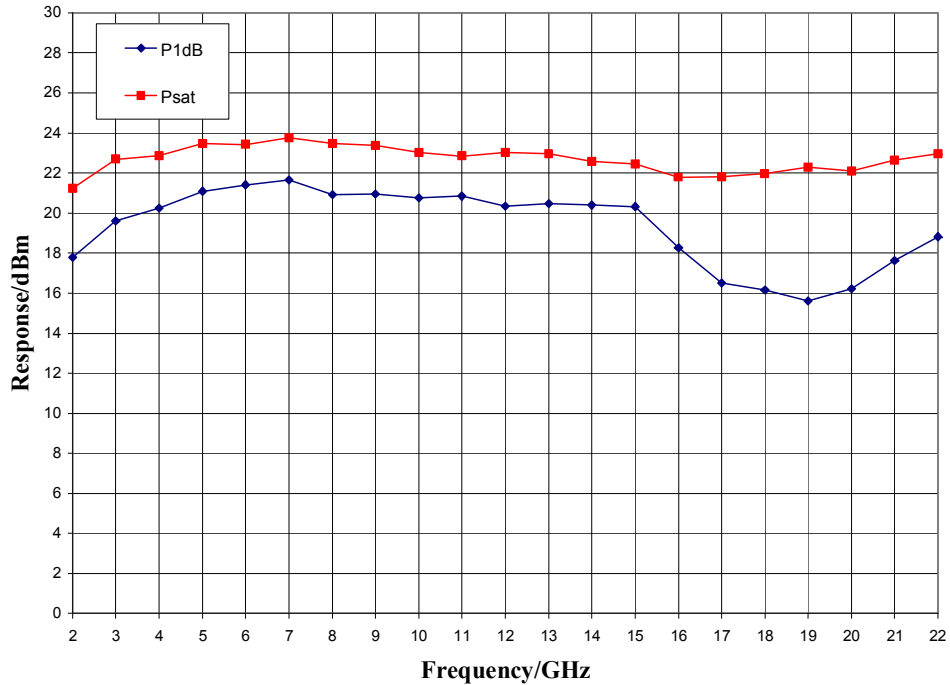

P1dB vs. Temperature, $V_{dd} = 5.0\text{ V}$, $V_{gg} = -0.65\text{ V}$

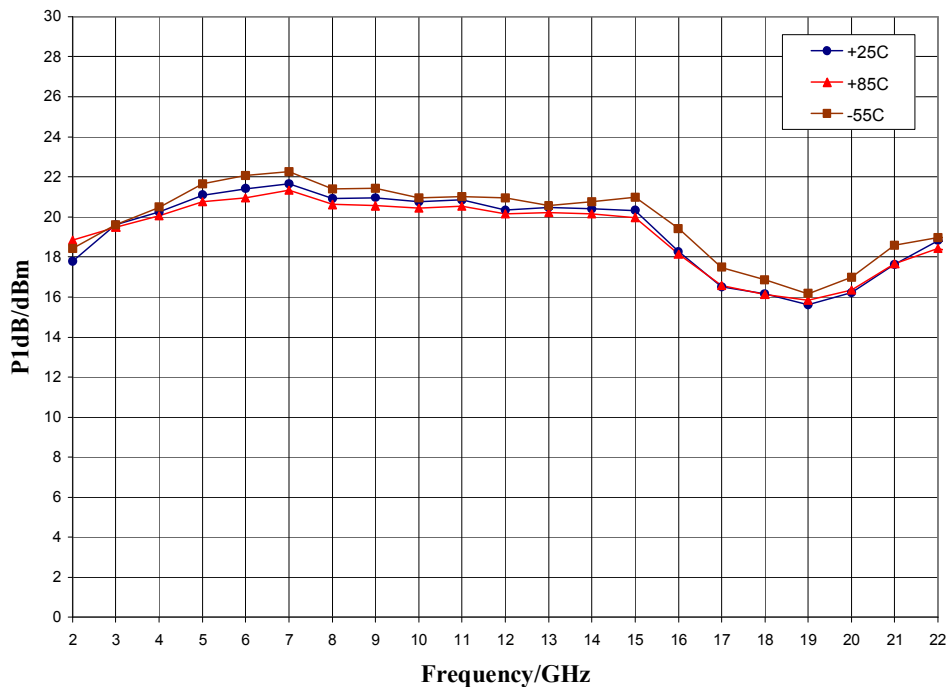

ver 1.5 1018

Typical Performance

Output IP3 vs. Temperature, $V_{dd} = 5.0\text{ V}$, $V_{gg} = -0.65\text{ V}$, $T_A = 25\text{ }^\circ\text{C}$

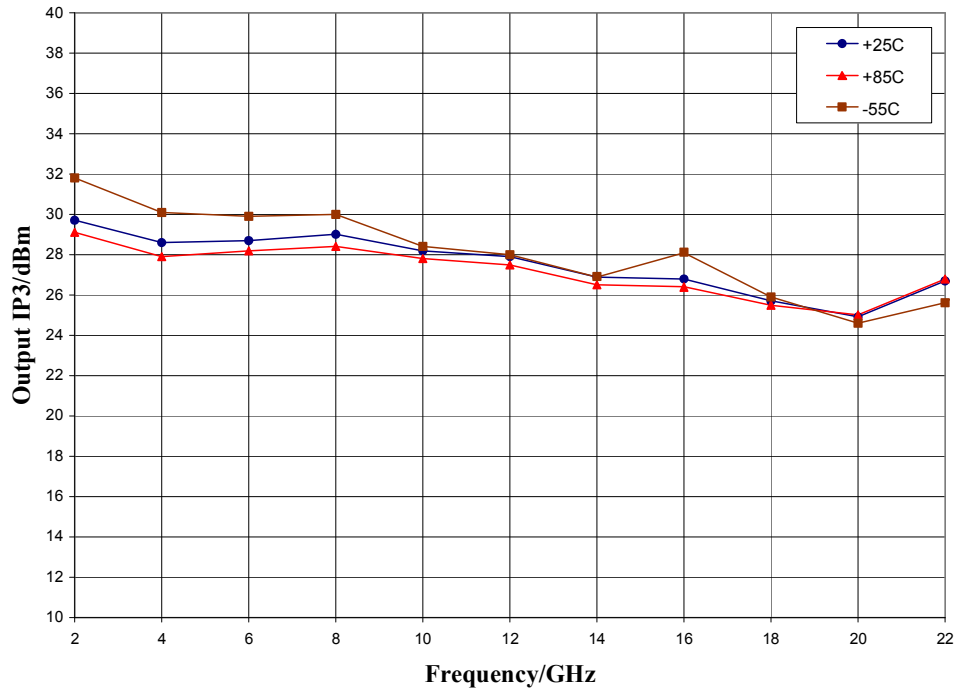

Mechanical Information

Die Outline (all dimensions in microns)

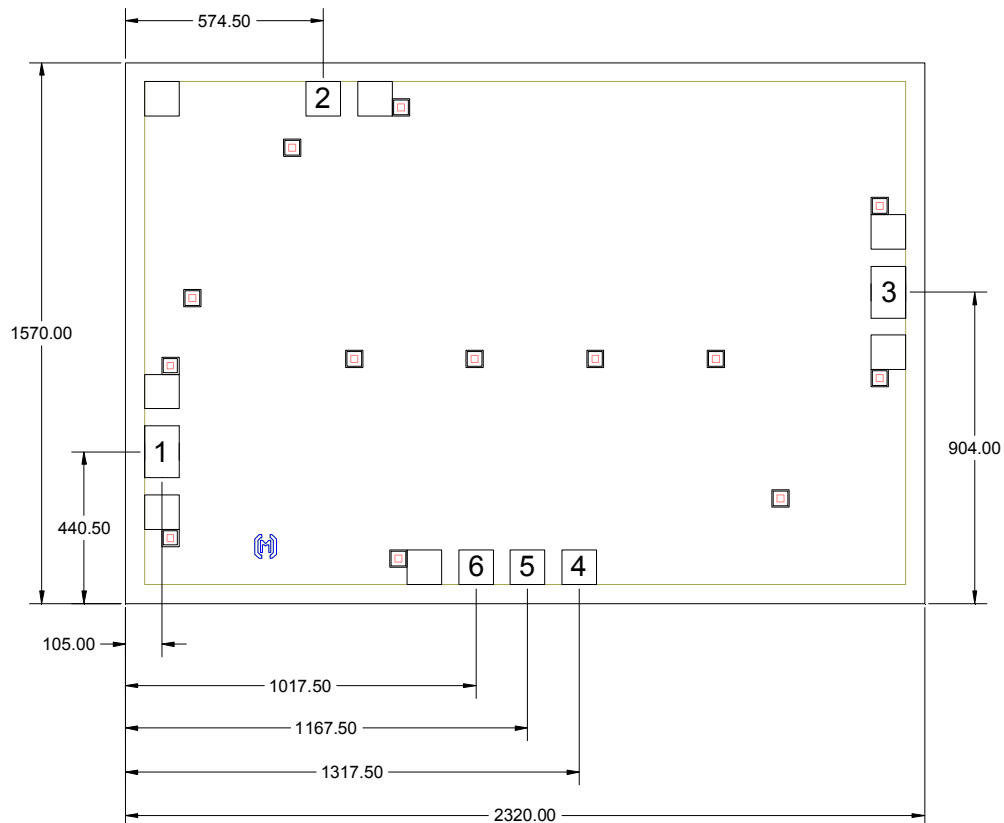

Notes:



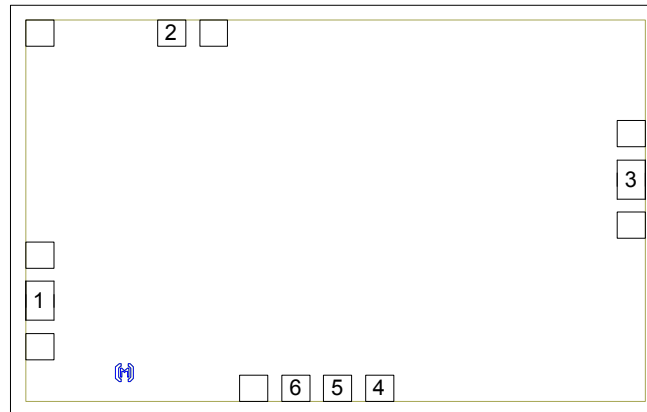

1. No connection required for unlabeled pads
2. Backside is RF and DC ground
3. Backside and bond pad metal: Gold
4. Die is 70 microns thick
5. DC bond pads (2, 4, 5, 6) are 100 x 100 microns
6. RF bond pads (1, 3) are 100 x 150 microns

Pad Description

Pad Diagram

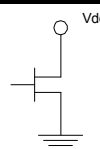

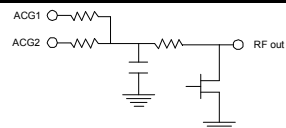
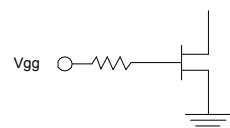
Functional Description

Pad	Function	Description	Schematic
1	RF in	DC blocked and 50 ohm matched	
2	Vdd	Power supply voltage Decoupling and bypass caps required	
3	RF out	DC blocked and 50 ohm matched	
4, 5	ACG1, 2	Low Frequency Termination Attach bypass capacitor per application circuit	
6	Vgg	Power supply voltage Decoupling and bypass caps required	
Backside	Ground	Connect to RF / DC ground	

Applications Information

Assembly Guidelines

The backside of the CMD241 is RF ground. Die attach should be accomplished with electrically and thermally conductive epoxy or eutectic attach. Standard assembly procedures should be followed for high frequency devices. The top surface of the semiconductor should be made planar to the adjacent RF transmission lines, and the RF decoupling capacitors placed in close proximity to the DC connections on chip.

RF connections should be made as short as possible to reduce the inductive effect of the bond wire. Use of a 0.8 mil thermosonic wedge bonding is highly recommended as the loop height will be minimized. The RF input and output require a double bond wire as shown.

The semiconductor is 70 um thick and should be handled by the sides of the die or with a custom collet. Do not make contact directly with the die surface as this will damage the monolithic circuitry. Handle with care.

Assembly Diagram

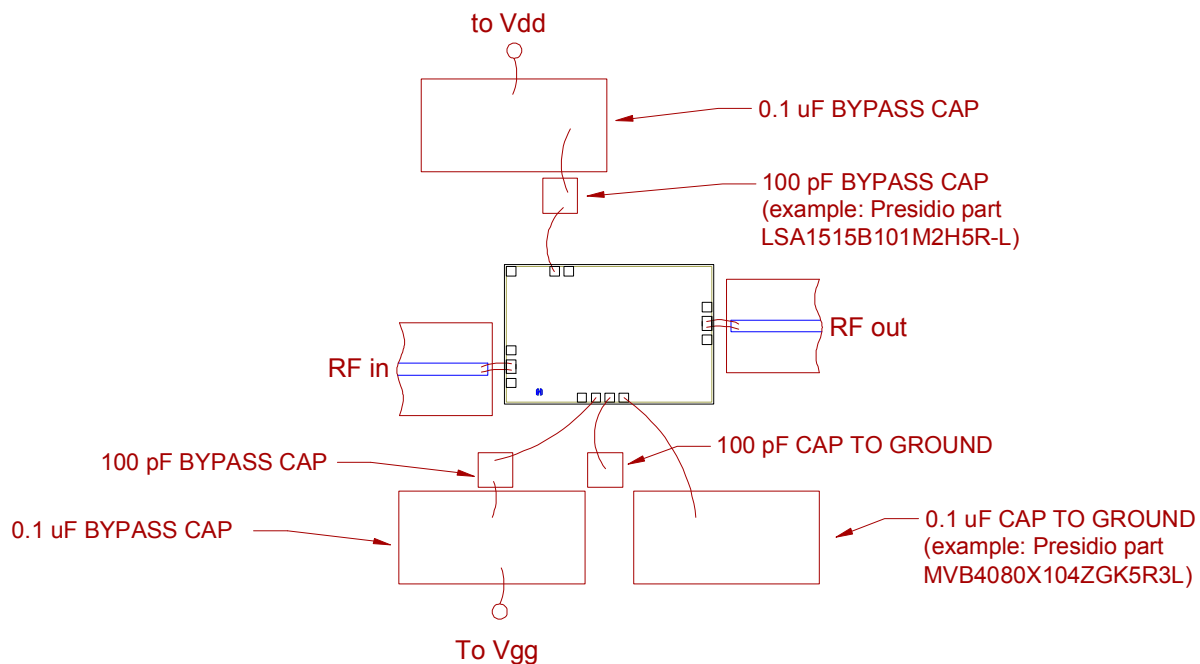

GaAs MMIC devices are susceptible to damage from Electrostatic Discharge. Proper precautions should be observed during handling, assembly and test.

Applications Information

Application Circuit

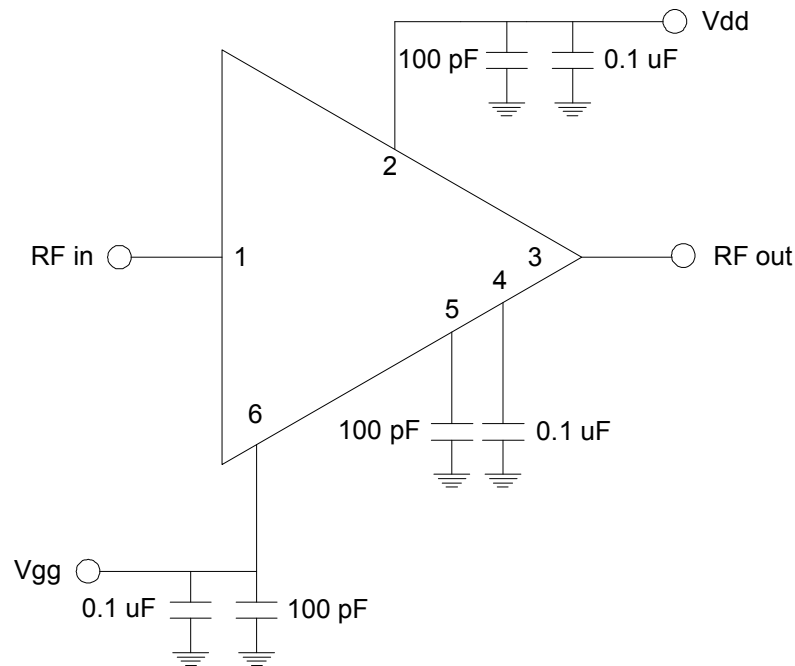

Biasing and Operation

The CMD241 is biased with a positive drain supply and a negative gate supply. Performance is optimized when the drain voltage is set to +5.0 V. The nominal gate voltage is -0.65 V.

Turn ON procedure:

1. Apply gate voltage V_{gg} and set to -2 V
2. Apply drain voltage V_{dd} and set to +5 V
3. Increase V_{gg} (less negative) to achieve a drain current of 74 mA

Turn OFF procedure:

1. Turn off drain voltage V_{dd}
2. Turn off gate voltage V_{gg}

RF power can be applied at any time.