

Features

- ▶ Wide bandwidth
- ▶ Single positive supply voltage
- ▶ Low noise figure
- ▶ Pb-free RoHs compliant 4x4 QFN package

Description

The CMD233C4 is a wideband GaAs MMIC low noise amplifier housed in a leadless 4x4 mm surface mount package. The CMD233C4 is ideally suited for military, space and communications systems where small size and low noise figure are needed over a wide bandwidth. At 10 GHz the device delivers greater than 9 dB of gain with a corresponding noise figure of 4.5 dB and an output 1 dB compression point of +20.5 dBm. The CMD233C4 is a 50 ohm matched design which eliminates the need for external DC blocks and RF port matching.

Functional Block Diagram

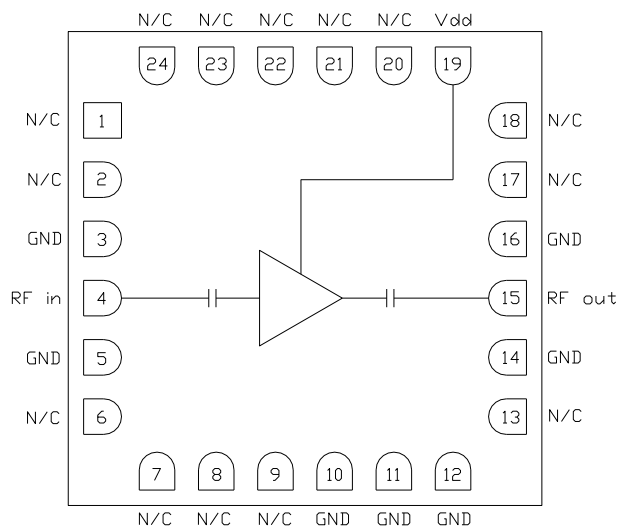

Electrical Performance – $V_{dd} = 5.0 \text{ V}$, $T_A = 25 \text{ }^\circ\text{C}$, $F=10 \text{ GHz}$

Parameter	Min	Typ	Max	Units
Frequency Range	2 – 18			GHz
Gain		9		dB
Noise Figure		4.5		dB
Input Return Loss		10		dB
Output Return Loss		20		dB
Output P1dB		20.5		dBm
Supply Current		120		mA



CMD233C4

2-20 GHz Distributed Low Noise Amplifier

Specifications

Absolute Maximum Ratings

Parameter	Rating
Drain Voltage, V _{dd}	7 V
RF Input Power	+23 dBm
Channel Temperature, T _{ch}	150 °C
Power Dissipation, P _{diss}	808 mW
Thermal Resistance	80.4 °C/W
Operating Temperature	-40 to 85 °C
Storage Temperature	-55 to 150 °C

Operation of this device outside the maximum ratings may cause permanent damage.

Recommended Operating Conditions

Parameter	Min	Typ	Max	Units
V _{dd}	3.0	5.0	6.0	V
I _{dd}		120		mA

Electrical performance is measured at specific test conditions. Electrical specifications are not guaranteed over all recommended operating conditions.

Electrical Specifications – V_{dd} = 5.0 V, T_A = 25 °C

Parameter	Min	Typ	Max	Min	Typ	Max	Min	Typ	Max	Units
Frequency Range	2 – 6			6 – 14			14 – 18			GHz
Gain	7	9.5	12	6.5	8.5	11.5	6.5	9	11.5	dB
Noise Figure		5.5	6.5		4.5	5.5		5	6.5	dB
Input Return Loss		10			12			15		dB
Output Return Loss		16			20			15		dB
Output P1dB		21			20.5			20.5		dBm
Output IP3		25.5			24			22		dBm
Supply Current	85	120	155	85	120	155	85	120	155	mA
Gain Temperature Coefficient		0.02			0.02			0.02		dB/°C
Noise Figure Temperature Coefficient		0.01			0.01			0.01		dB/°C

ver 1.1 0817

Typical Performance

Broadband Performance, $V_{dd} = 5.0\text{ V}$, $I_{dd} = 120\text{ mA}$, $T_A = 25\text{ }^\circ\text{C}$

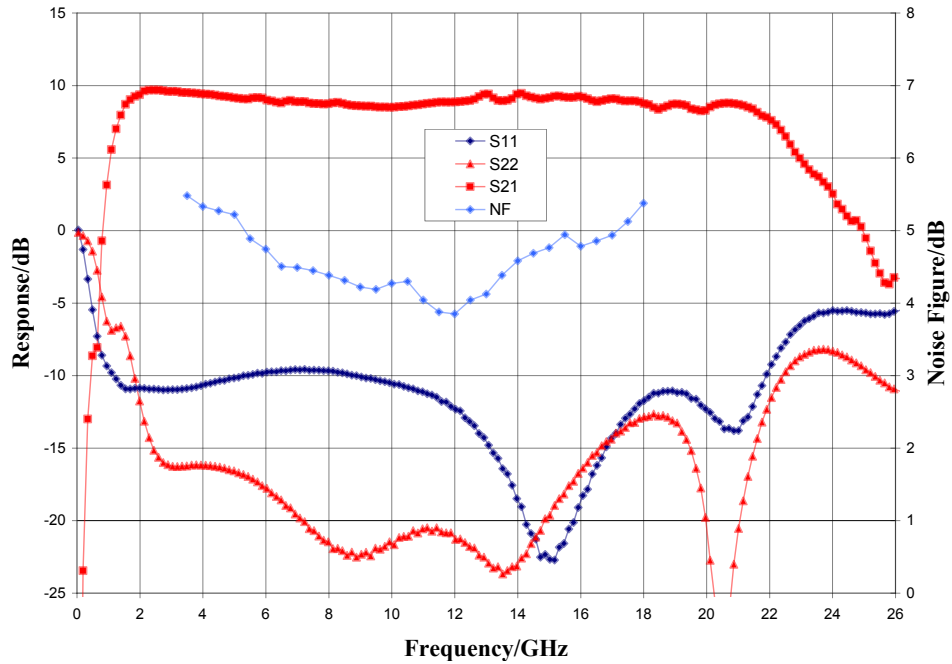

Narrow-band Performance, $V_{dd} = 5.0\text{ V}$, $I_{dd} = 120\text{ mA}$, $T_A = 25\text{ }^\circ\text{C}$

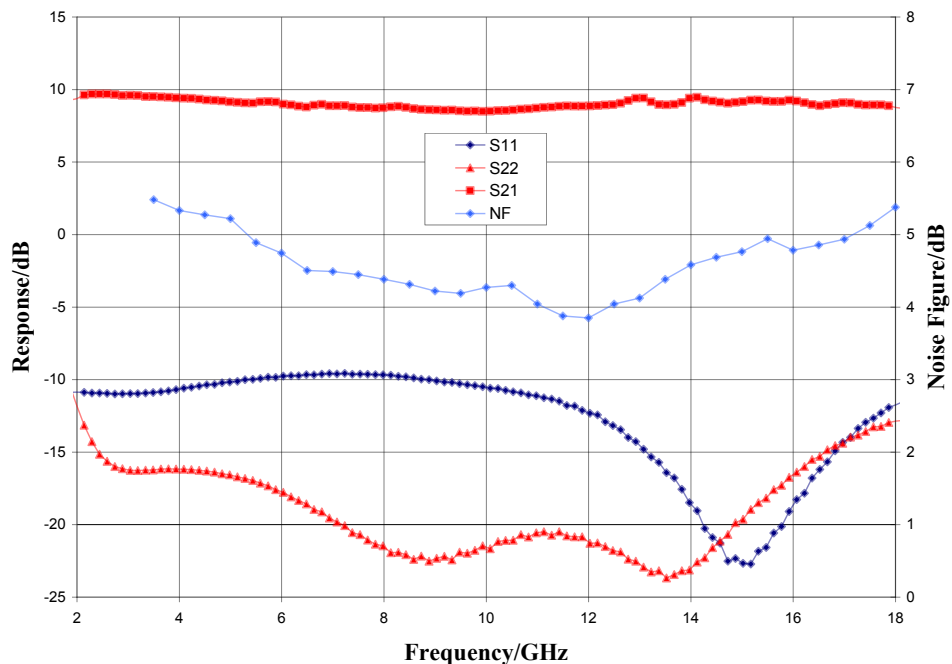

ver 1.1 0817

Typical Performance

Gain vs. Temperature, $V_{dd} = 5.0\text{ V}$

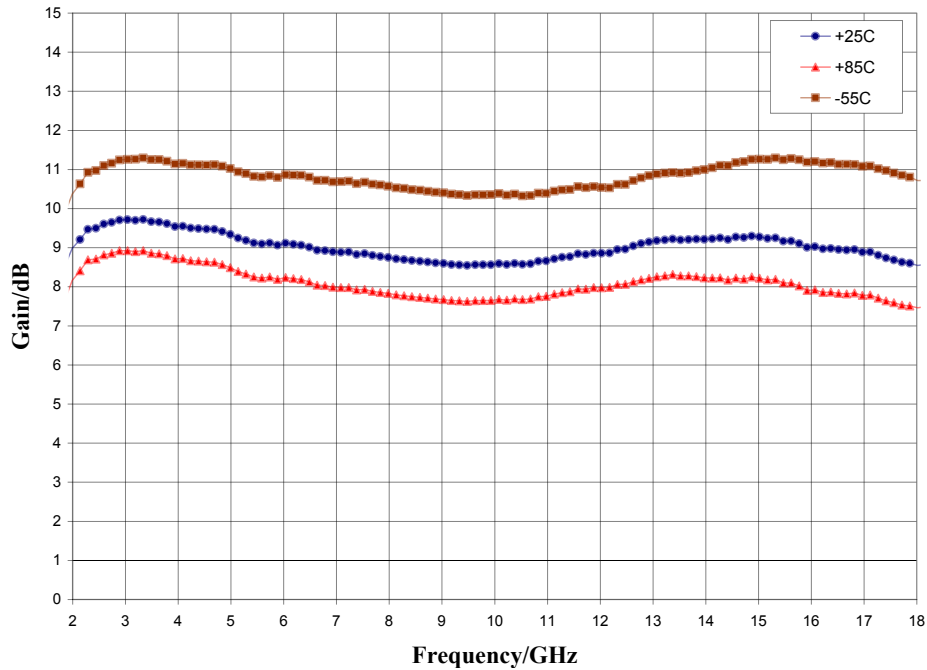

Gain vs. Supply Voltage, $T_A = 25\text{ }^\circ\text{C}$

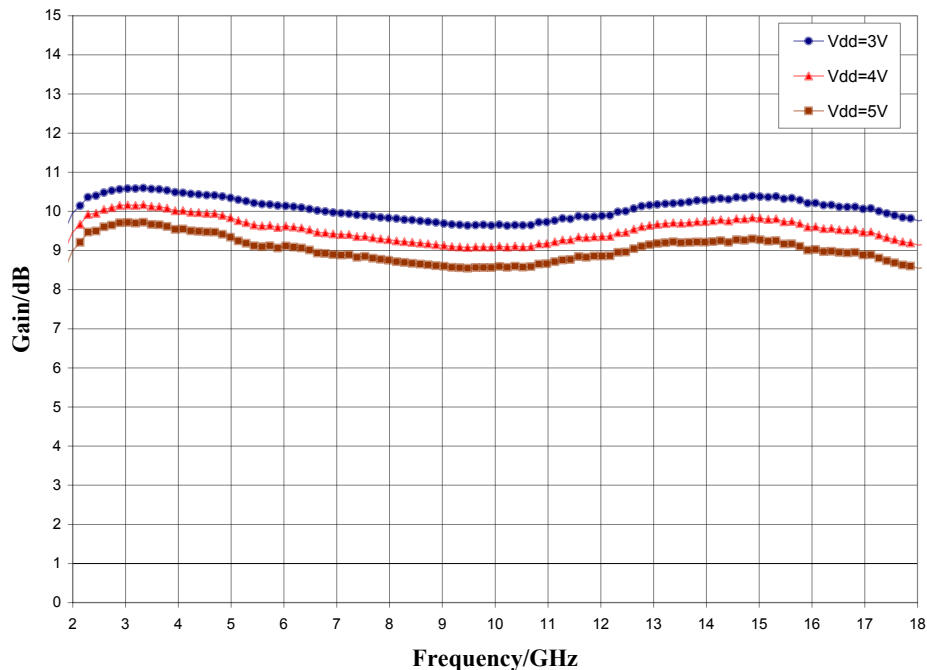

ver 1.1 0817

Typical Performance

Noise Figure vs. Temperature, $V_{dd} = 5.0\text{ V}$

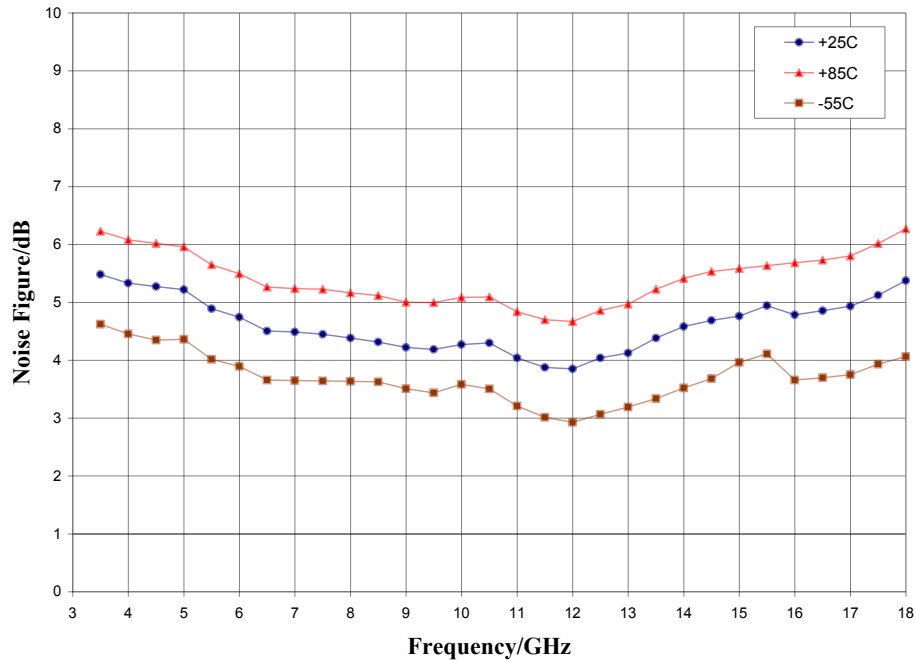

Noise Figure vs. Supply Voltage, $T_A = 25\text{ }^\circ\text{C}$

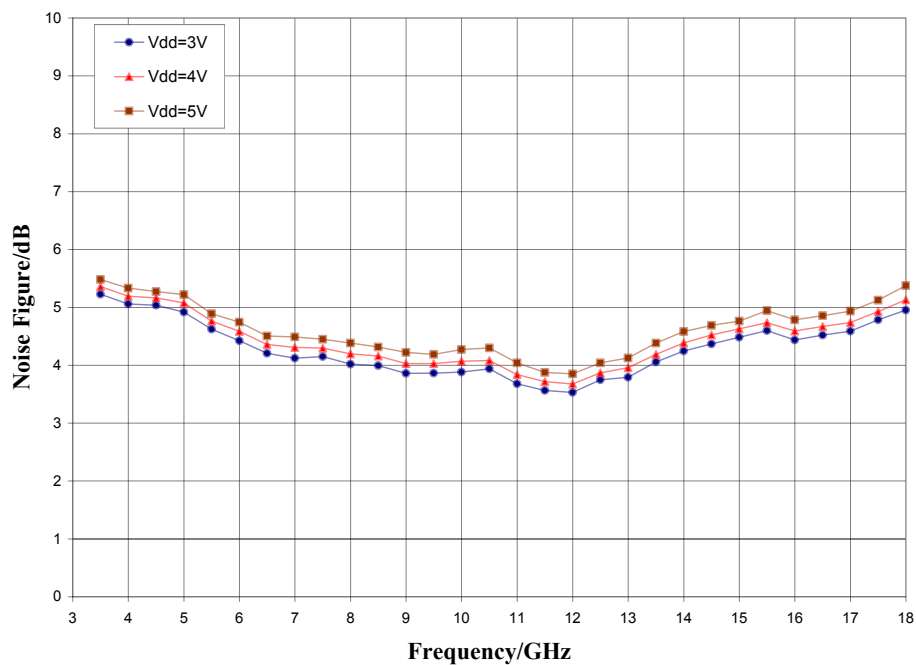

ver 1.1 0817

Typical Performance

P1dB vs. Temperature, $V_{dd} = 5.0\text{ V}$

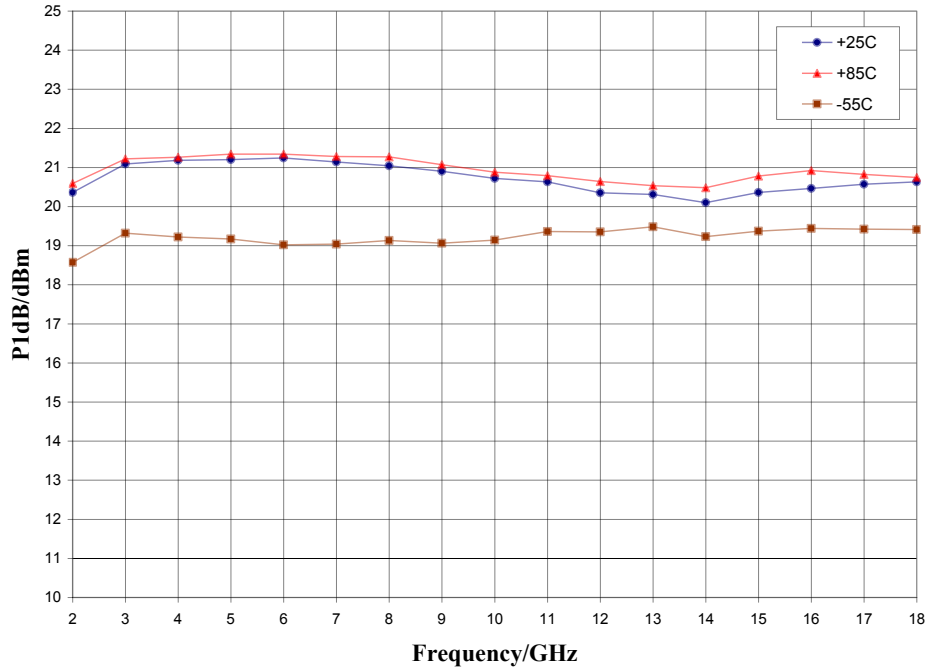

P1dB vs. Supply Voltage, $T_A = 25\text{ }^\circ\text{C}$

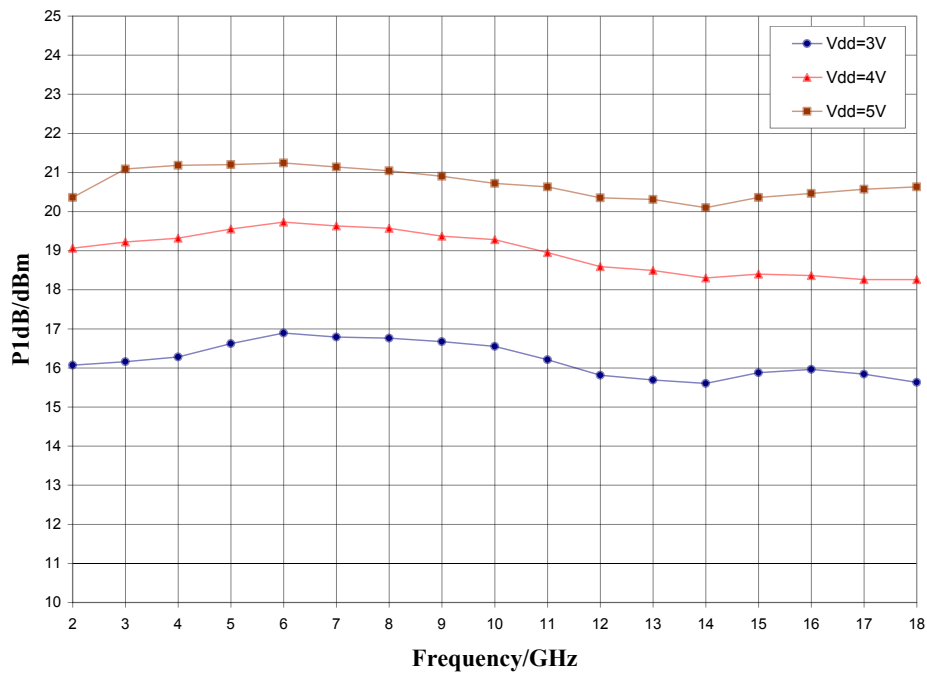

ver 1.1 0817

Typical Performance

Output IP3 vs. Temperature, $V_{dd} = 5.0$ V

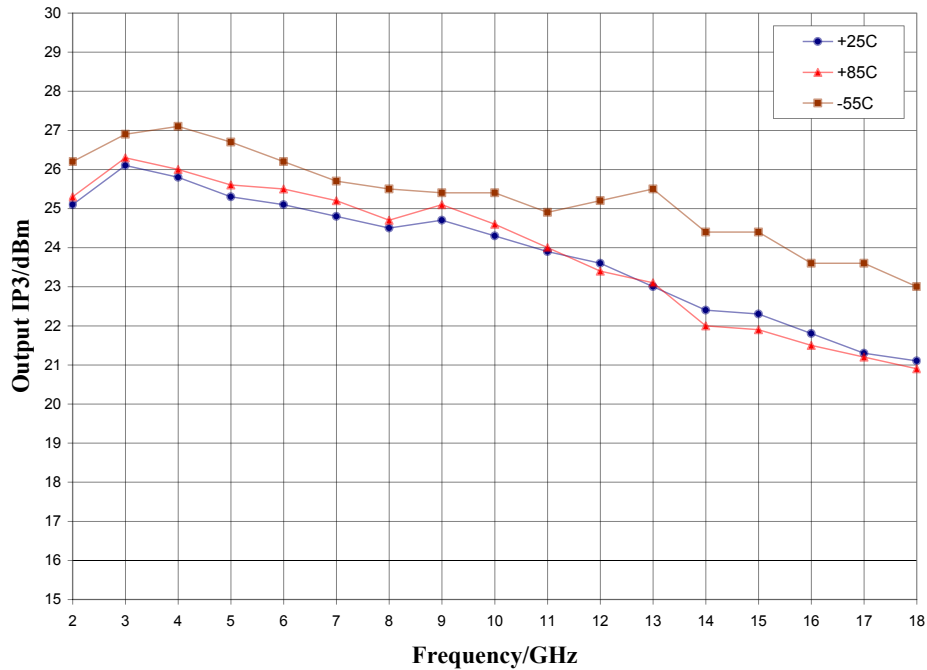

Output IP3 vs. Supply Voltage, $T_A = 25$ °C

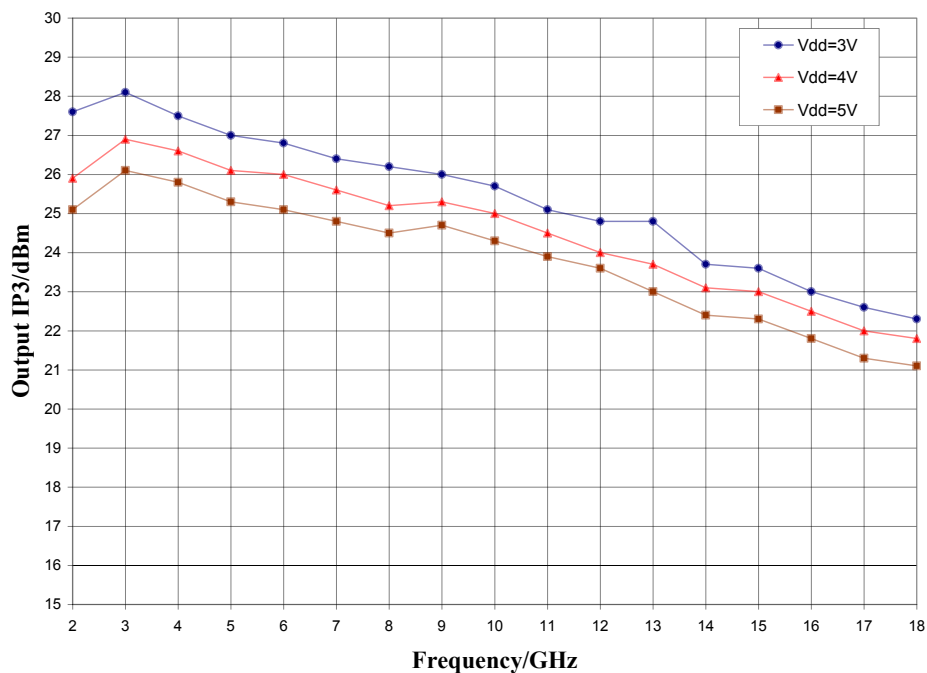

ver 1.1 0817

Typical Performance

Output Power, $V_{dd} = 5.0\text{ V}$, $T_A = 25\text{ }^\circ\text{C}$

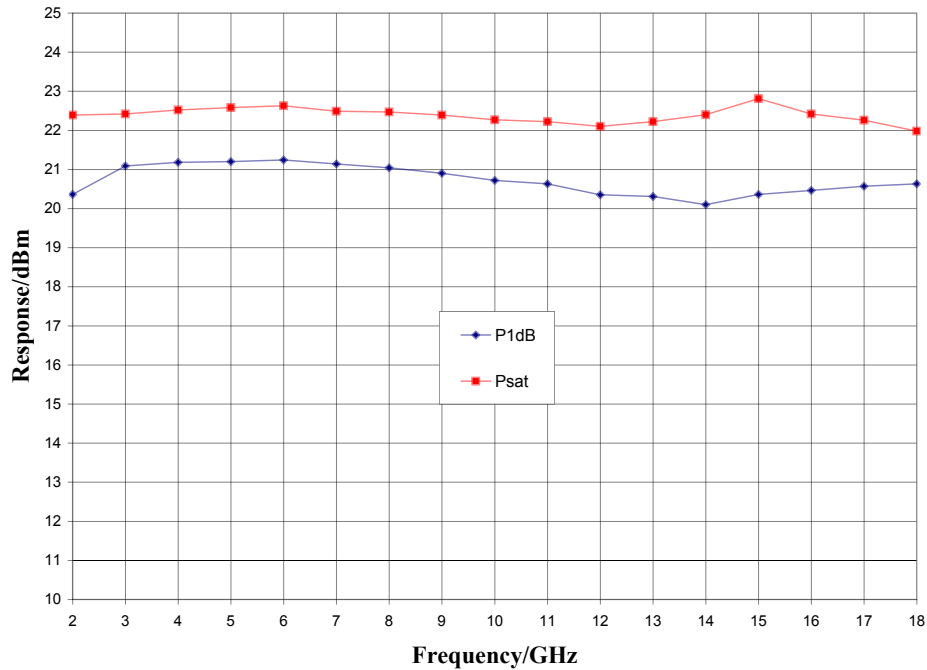

Mechanical Information

Package Information and Dimensions

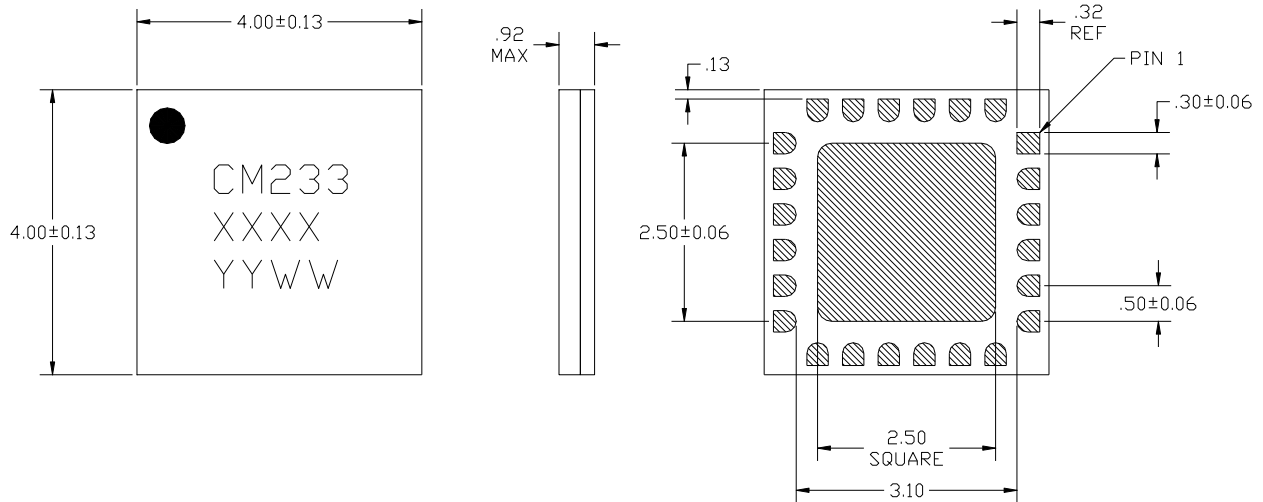

- NOTES:
1. DIMENSIONS ARE IN MILLIMETERS
 2. MATERIAL: BLACK ALUMINA
 3. LEAD FINISH: 30-80 MICRONS GOLD OVER 50 MICRONS NICKEL.
 4. ALTERNATE PIN #1 IDENTIFIER IS SINGLE SQUARE PAD.

Recommended PCB Land Pattern

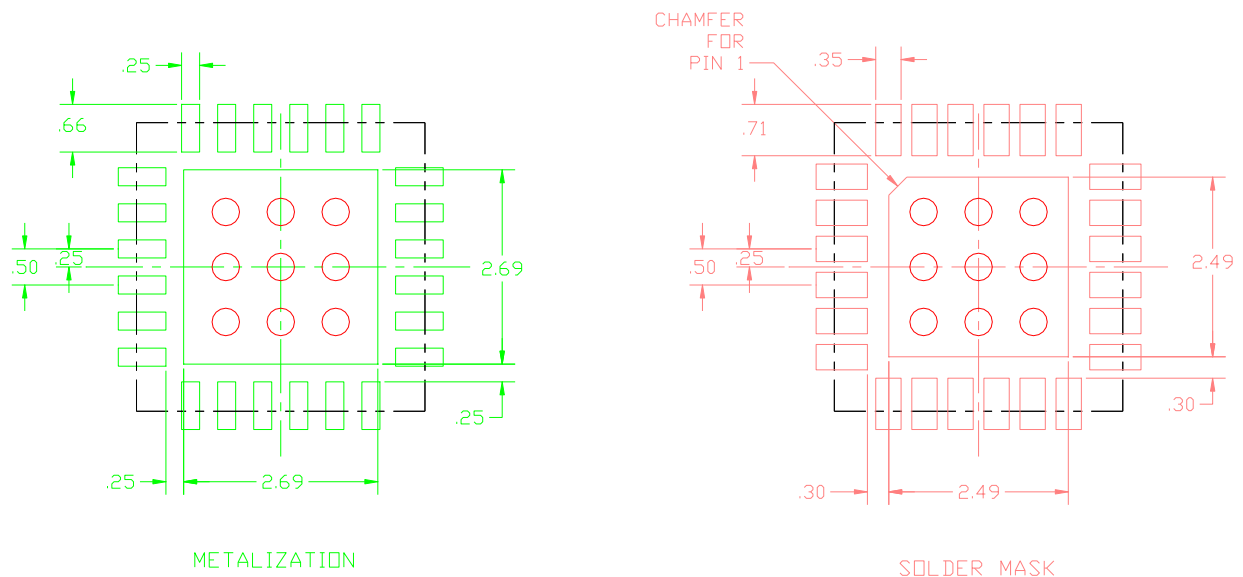

ver 1.1 0817

Pin Description

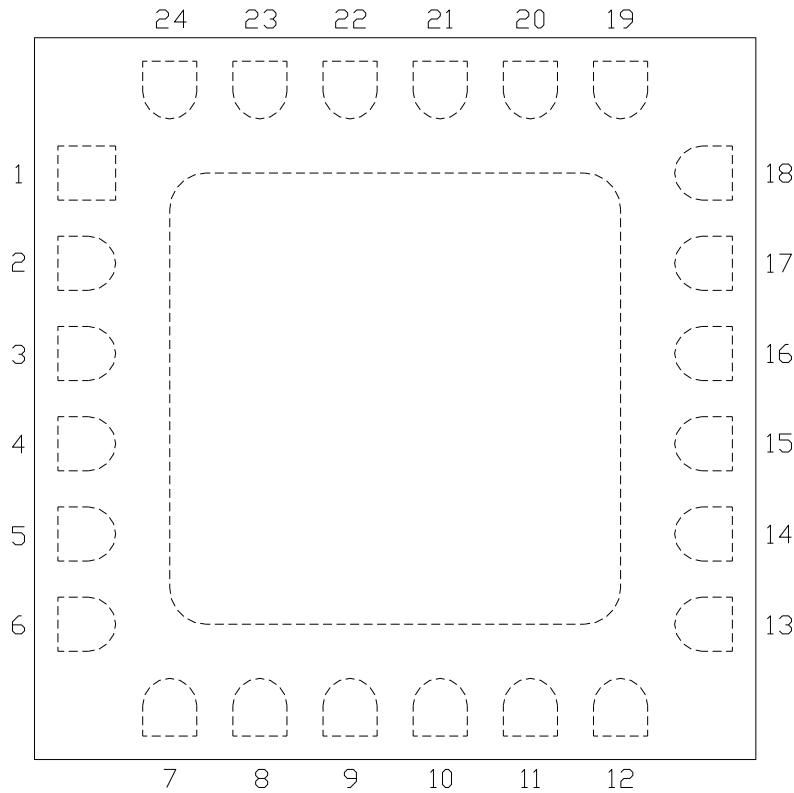

Functional Description

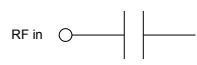
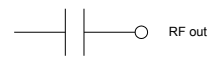
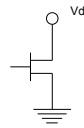
Pin	Function	Description	Schematic
1, 2, 6-9, 13, 17, 18, 20-24	N/C	No connection required. These pins may be connected to RF/DC ground	
3, 5, 10-12, 14, 16 and die pad-dle	Ground	Connect to RF/DC ground	
4	RF in	DC blocked and 50 ohm matched	
15	RF out	DC blocked and 50 ohm matched	
19	Vdd	Power supply voltage Decoupling and bypass caps required	

ver 1.1 0817

Applications Information

Application Circuit

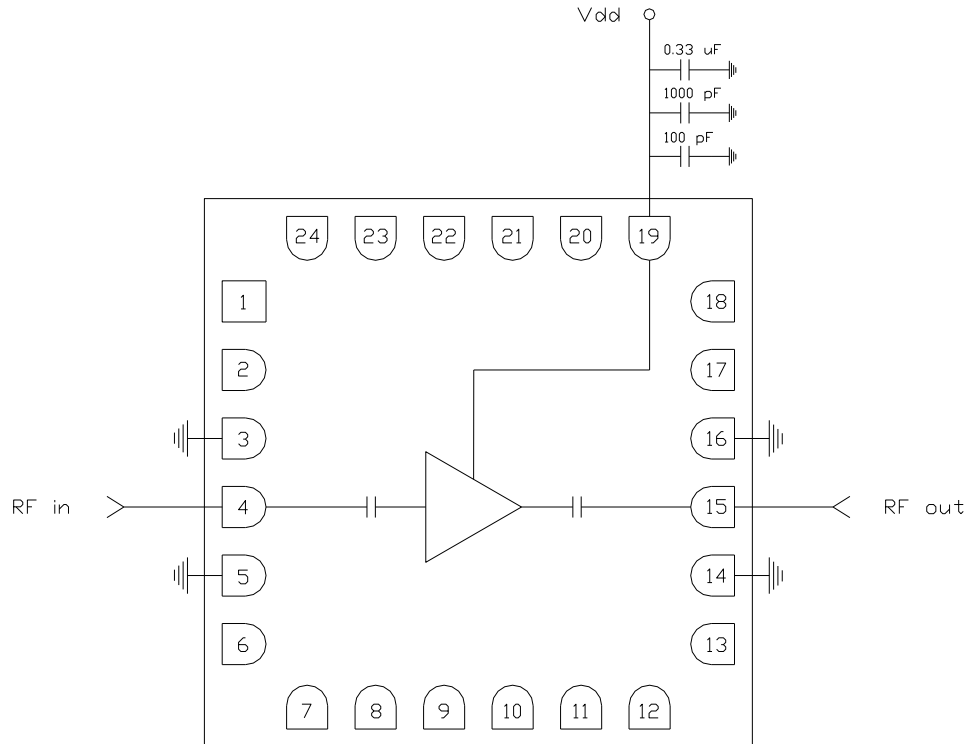

Biasing and Operation

The CMD233C4 is biased with a single positive drain supply. Performance is optimized when the drain voltage is set to +5.0 V.

Turn ON procedure:

1. Apply drain voltage V_{dd} and set to +5 V

Turn OFF procedure:

1. Turn off drain voltage V_{dd}

RF power can be applied at any time.

GaAs MMIC devices are susceptible to damage from Electrostatic Discharge. Proper precautions should be observed during handling, assembly and test.

ver 1.1 0817

Applications Information

Evaluation Board

The circuit board shown has been developed for optimized assembly at Custom MMIC. A sufficient number of via holes should be used to connect the top and bottom ground planes. As surface mount processes vary, careful process development is recommended.

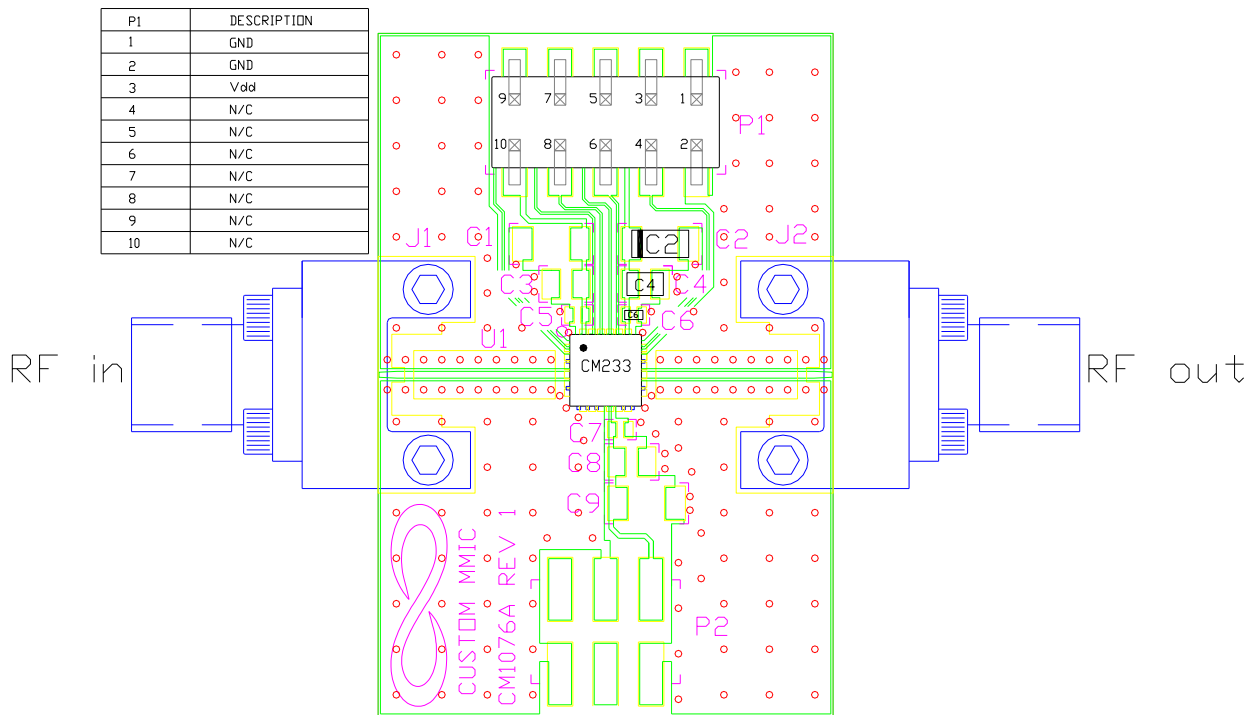

Designator	Value	Description
J1, J2		SMA End Launch Connector
P1		10 Pin Header
C2	0.33 μ F	Capacitor, Tantalum
C4	1000 pF	Capacitor, 0603
C6	100 pF	Capacitor, 0402
U1		CMD233C4 Low Noise Amplifier
PCB		CM1076A Evaluation PCB