



CMD227C3

Frequency Doubler, 8-15 GHz Input

Features

- ▶ Low conversion loss
- ▶ Excellent Fo isolation
- ▶ Broadband performance
- ▶ No bias required
- ▶ Pb-free RoHS compliant 3x3 SMT package

Description

The CMD227C3 is a broadband MMIC GaAs x2 passive frequency multiplier in a ceramic, QFN-style package. When driven by a +15 dBm signal, the multiplier provides 11 dB conversion loss at an output frequency of 23 GHz. The Fo and 3Fo isolations are 38 dBc and 49 dBc respectively. The CMD227C3 is a 50 ohm matched design eliminating the need for RF port matching.

Functional Block Diagram

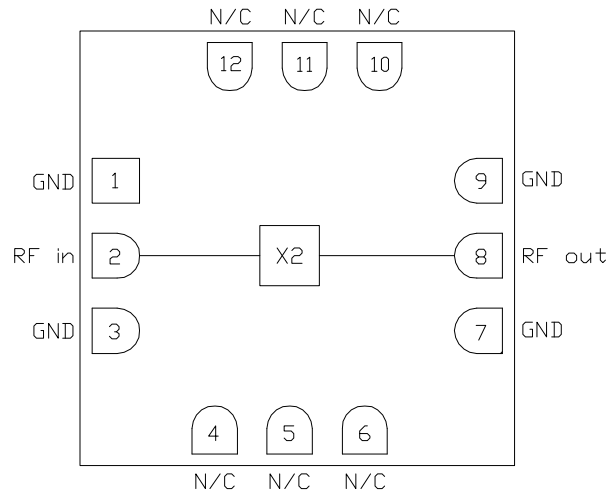

Electrical Performance – $T_A = 25\text{ }^\circ\text{C}$, $P_{in} = +15\text{ dBm}$, $F_{in} = 11.5\text{ GHz}$

Parameter	Min	Typ	Max	Units
Frequency Range, Input	8 – 15			GHz
Frequency Range, Output	16 – 30			GHz
Conversion Loss		11		dB
Fo Isolation (with respect to input level)		38		dB
3Fo Isolation (with respect to input level)		49		dB

ver 1.0 0218



CMD227C3

Frequency Doubler, 8-15 GHz Input

Specifications

Absolute Maximum Ratings

Parameter	Rating
RF Input Power	+27 dBm
Operating Temperature	-40 to 85 °C
Storage Temperature	-55 to 150 °C

Exceeding any one or combination of the maximum ratings may cause permanent damage to the device.

Electrical Specifications – $T_A = 25\text{ °C}$, $P_{in} = +15\text{ dBm}$

Parameter	Min	Typ	Max	Min	Typ	Max	Units
Frequency Range, Input	8 – 15			10 – 13			GHz
Frequency Range, Output	16 – 30			20 – 26			GHz
Conversion Loss		13	19		11	15.5	dB
Fo Isolation (with respect to input level)	37	44		37	44		dB
3Fo Isolation (with respect to input level)	37	44		37	44		dB

ver 1.0 0218

Typical Performance

Conversion Gain vs. Temperature @ +15 dBm Drive Level

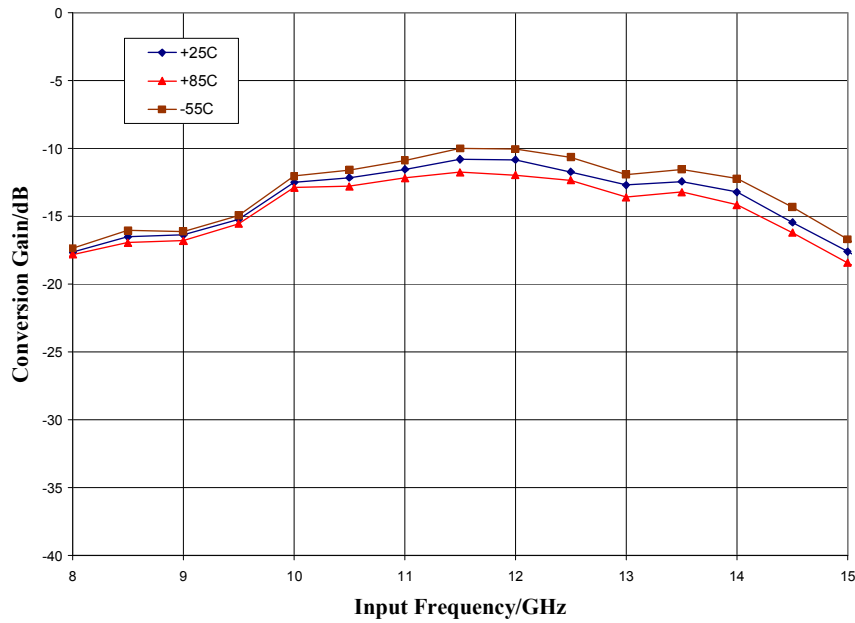

Conversion Gain vs. Drive Level, T_A = 25 °C

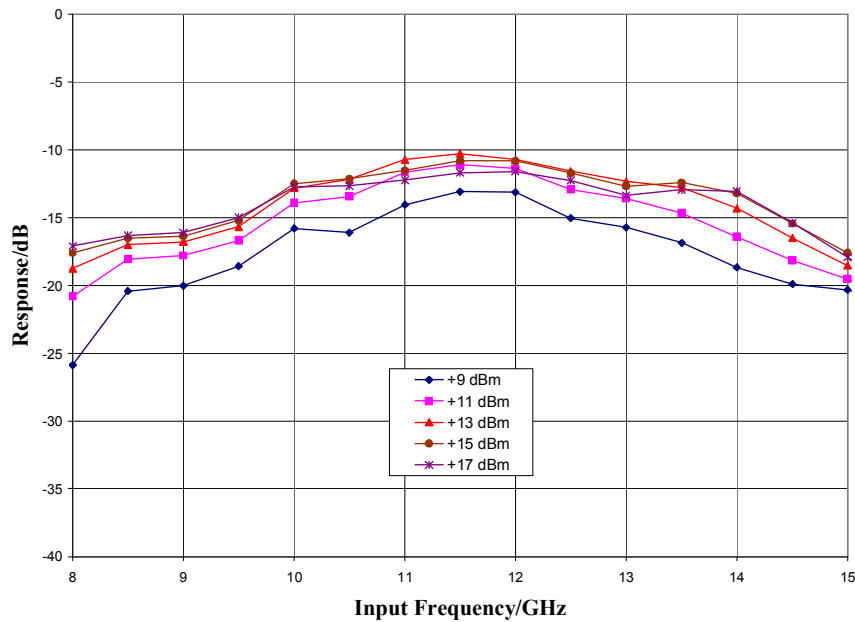

Typical Performance

Isolation (with respect to input level) @ +15 dBm Drive Level, $T_A = 25\text{ }^\circ\text{C}$

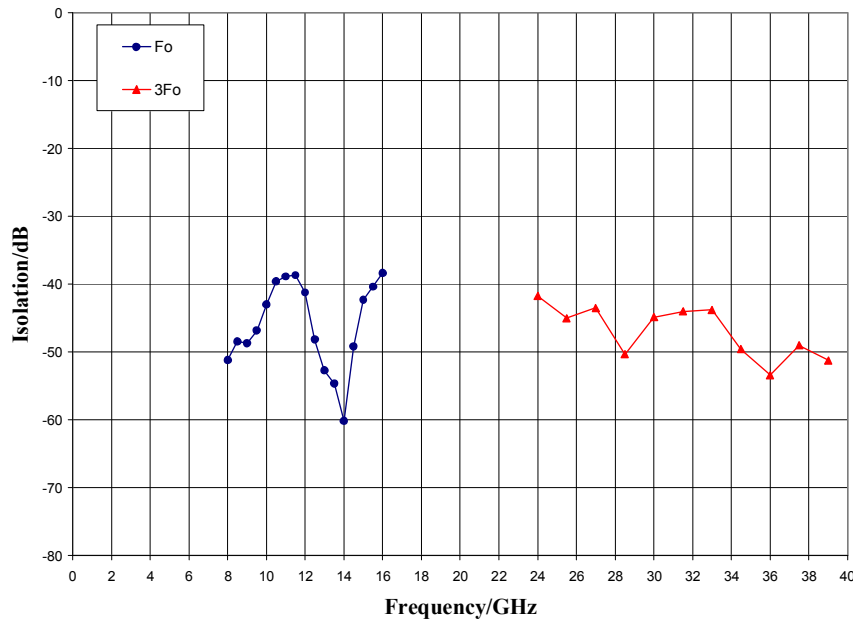

Output Spectrum @ +15 dBm Drive Level, $T_A = 25\text{ }^\circ\text{C}$

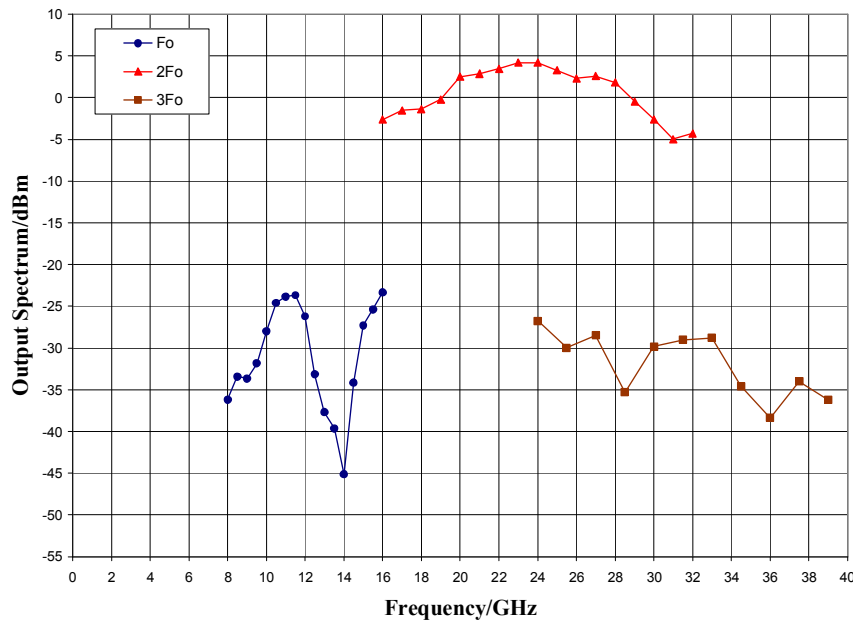

Typical Performance

Input Return Loss @ +15 dBm Drive Level, $T_A = 25\text{ }^\circ\text{C}$

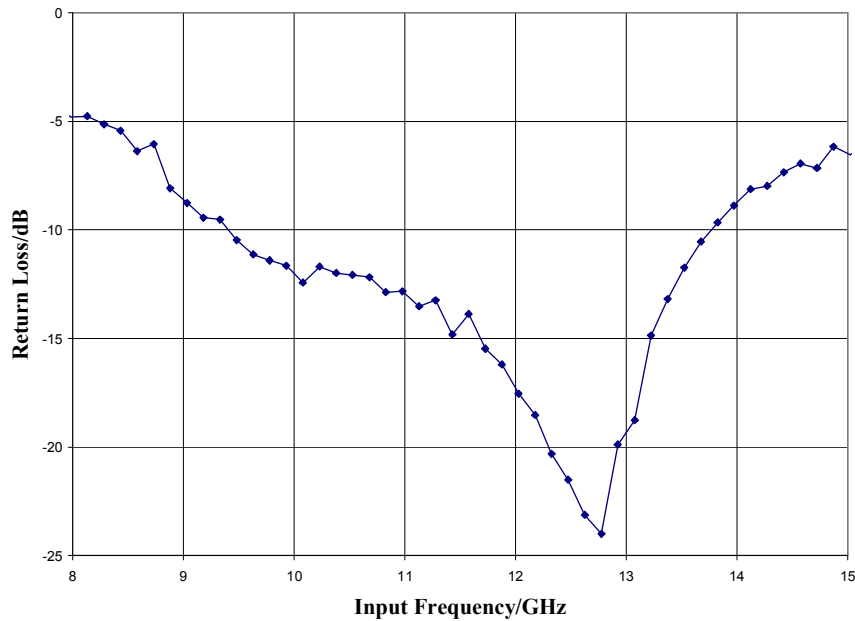

Output Return Loss @ +15 dBm Drive Level, $F = 11.5\text{ GHz}$ Input, $T_A = 25\text{ }^\circ\text{C}$

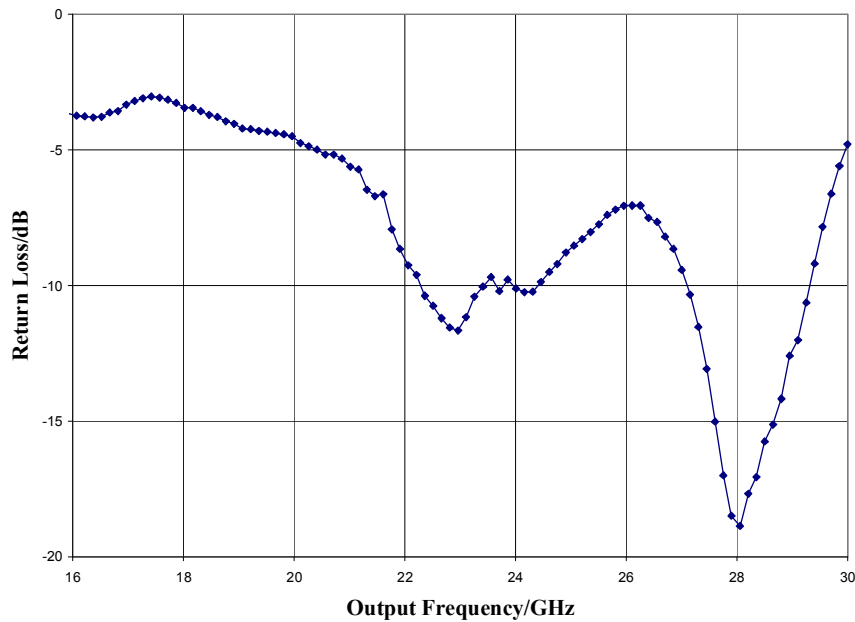

Mechanical Information

Package Information and Dimensions

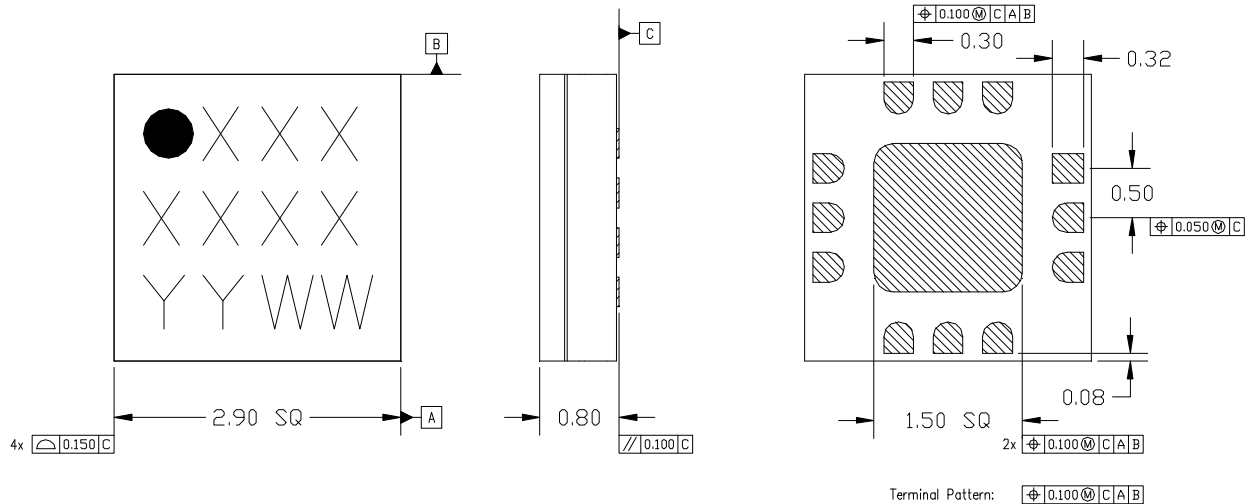

- NOTES:
1. ALL DIMENSIONS SHOWN IN mm.
 2. MATERIAL: BLACK ALUMINA
 3. LEAD FINISH:
 - 3.1. Ni: 8.89um MAX, 1.27um MIN
 - 3.2. Pd: 0.17um MAX, 0.07um MIN
 - 3.3. Au: 0.254um MAX, 0.03um MIN
 4. MARKING
 - 4.1. LINE 1: PART NUMBER
 - 4.1.1. EXAMPLE: CMD177C3 SHALL BE MARKED AS 177
 - 4.2. LINE 2: LDT NUMBER
 - 4.3. LINE 3: DATE CODE - LAST 2 DIGITS OF THE YEAR OF MANUFACTURE FOLLOWED BY A 2 DIGIT WEEK CODE
 5. ALTERNATE PIN #1 IDENTIFIER IS A SINGLE SQUARE PAD
 6. ALTERNATE DIE PADDLE MAY HAVE CHAMFERED CORNERS

Recommended PCB Land Pattern

Custom MMIC Design Services recommends that the user develop the land pattern that will provide the best design for proper solder reflow and device attach for their specific application. Please review Custom MMIC Application Note AN 105 for a recommended land pattern approach.

Recommended Solder Reflow Profile



Custom MMIC Design Services recommends screen printing with belt furnace reflow to ensure proper solder reflow and device attach. Please review Custom MMIC Application Note AN 102 for a recommended solder reflow profile.

Pin Description

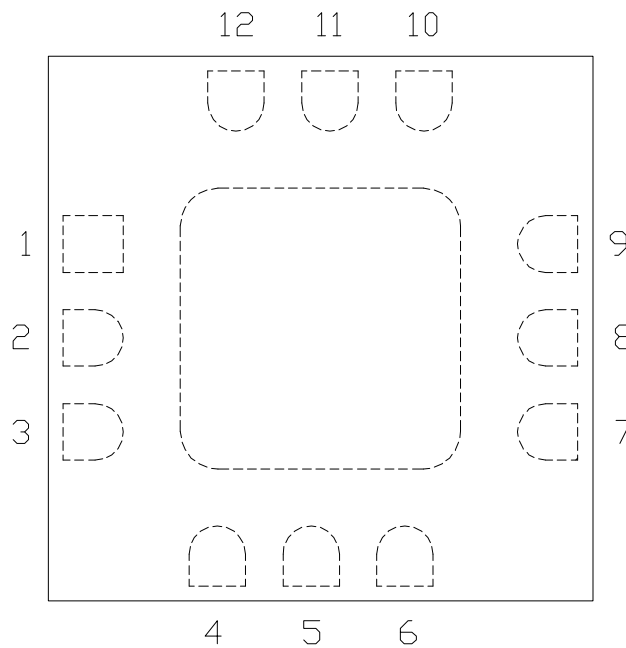
Pin Diagram

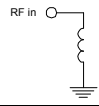

Functional Description

Pad	Function	Description	Schematic
1, 3, 7, 9 and die paddle	Ground	Connect to RF / DC ground	
2	RF in	Pin is DC coupled and 50 ohm matched	
4-6, 10-12	N/C	No connection required. These pins may be connected to RF/DC ground	
8	RF out	Pin is DC coupled and 50 ohm matched	

Applications Information

Evaluation Board

The circuit board shown has been developed for optimized assembly at Custom MMIC. A sufficient number of via holes should be used to connect the top and bottom ground planes. As surface mount processes vary, careful process development is recommended.

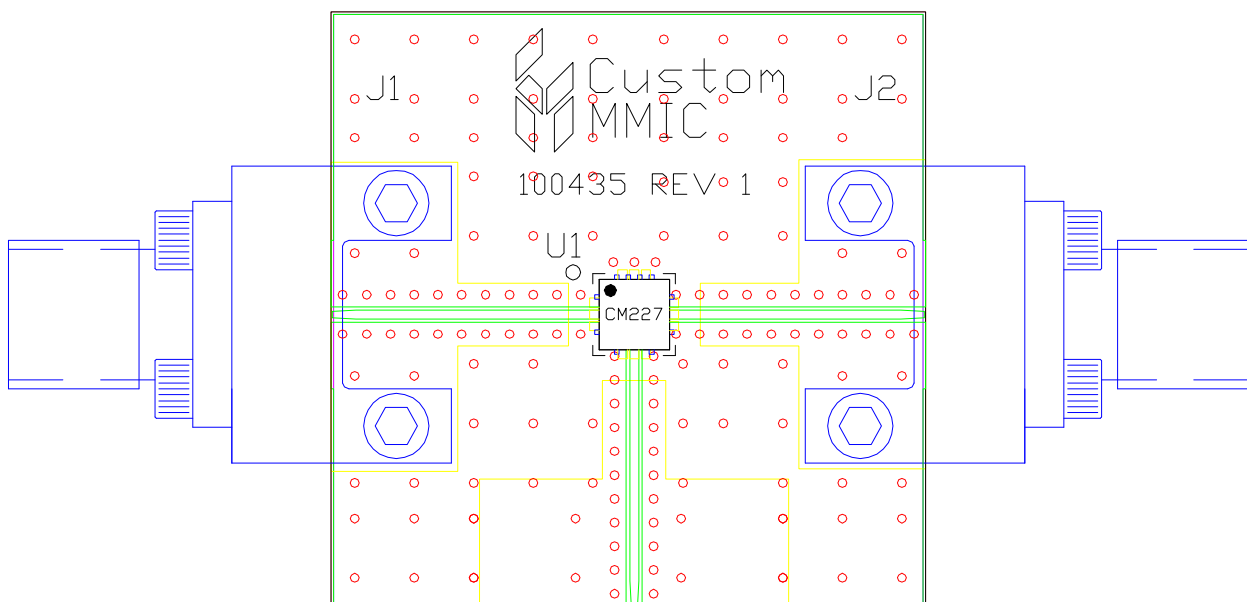

Bill of Material

Designator	Value	Description
J1 - J2		SMA End Launch Connector
U1		CMD227C3 Frequency Doubler
PCB		100435 Evaluation PCB

GaAs MMIC devices are susceptible to damage from Electrostatic Discharge. Proper precautions should be observed during handling, assembly and test.

Please note, all information contained in this data sheet is subject to change without notice.

ver 1.0 0218