



CMD226C3

Frequency Doubler, 7-11 GHz Input

Features

- ▶ Low conversion loss
- ▶ Excellent Fo isolation
- ▶ Broadband performance
- ▶ No bias required

Description

The CMD226C3 is a broadband MMIC GaAs x2 passive frequency multiplier in a ceramic, QFN-style package. When driven by a +15 dBm signal, the multiplier provides 10.5 dB conversion loss at an output frequency of 18 GHz. The Fo and 3Fo isolations are 44 dBc and 46 dBc respectively. The CMD226C3 is a 50 ohm matched design eliminating the need for RF port matching.

Functional Block Diagram

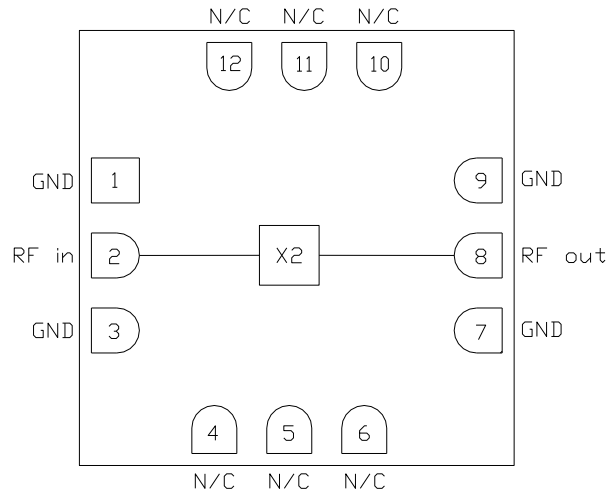

Electrical Performance – $T_A = 25^\circ\text{C}$, $P_{in} = +15\text{ dBm}$, $F_{in} = 9\text{ GHz}$

Parameter	Min	Typ	Max	Units
Frequency Range, Input	7 – 11			GHz
Frequency Range, Output	14 – 22			GHz
Conversion Loss		9		dB
Fo Isolation (with respect to input level)		44		dB
3Fo Isolation (with respect to input level)		48		dB
4Fo Isolation (with respect to input level)		50		dB

ver 1.1 0817



CMD226C3

Frequency Doubler, 7-11 GHz Input

Specifications

Absolute Maximum Ratings

Parameter	Rating
RF Input Power	+27 dBm
Operating Temperature	-40 to 85 °C
Storage Temperature	-55 to 150 °C

Operation of this device outside the maximum ratings may cause permanent damage.

Electrical Specifications – $T_A = 25\text{ °C}$, $P_{in} = +15\text{ dBm}$

Parameter	Min	Typ	Max	Min	Typ	Max	Units
Frequency Range, Input	7 – 11			8 – 10			GHz
Frequency Range, Output	14 – 22			16 – 20			GHz
Conversion Loss		11	17		10.5	13	dB
Fo Isolation (with respect to input level)	33	44		33	44		dB
3Fo Isolation (with respect to input level)	37	50		45	52		dB
4Fo Isolation (with respect to input level)	22	45		35	45		dB

ver 1.1 0817

Typical Performance

Conversion Gain vs. Temperature @ +15 dBm Drive Level

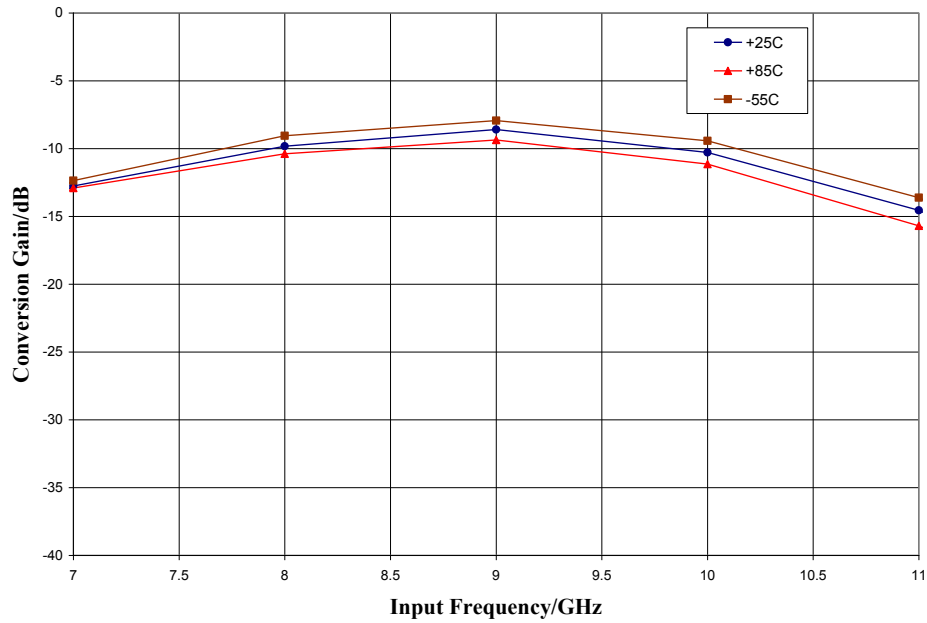

Conversion Gain vs. Drive Level, $T_A = 25^\circ\text{C}$

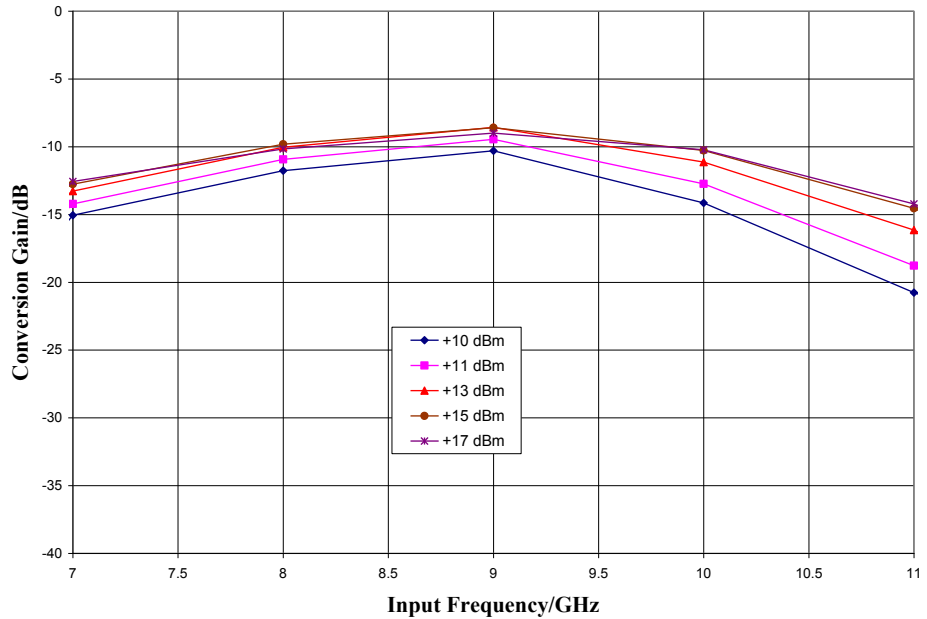

ver 1.1 0817

Typical Performance

Isolation (with respect to input level) @ +15 dBm Drive Level, $T_A = 25\text{ }^\circ\text{C}$

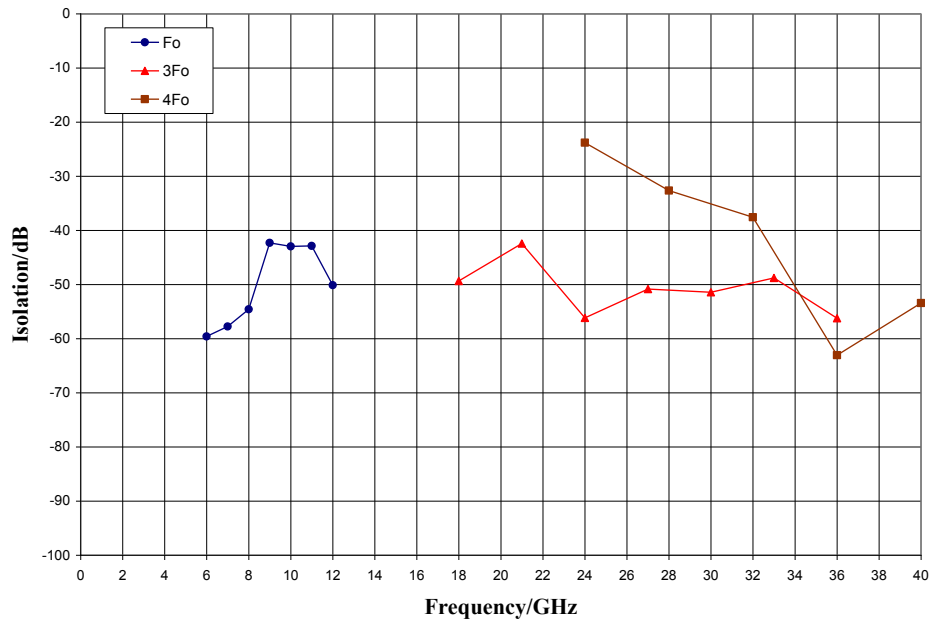

Output Spectrum @ +15 dBm Drive Level, $T_A = 25\text{ }^\circ\text{C}$

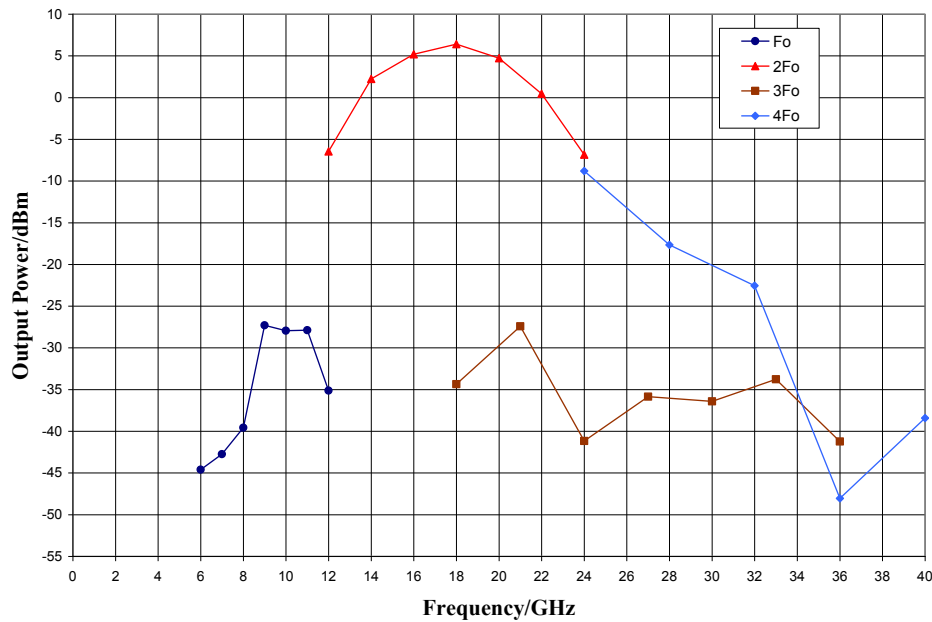

Typical Performance

Input Return Loss @ +15 dBm Drive Level, $T_A = 25\text{ }^\circ\text{C}$

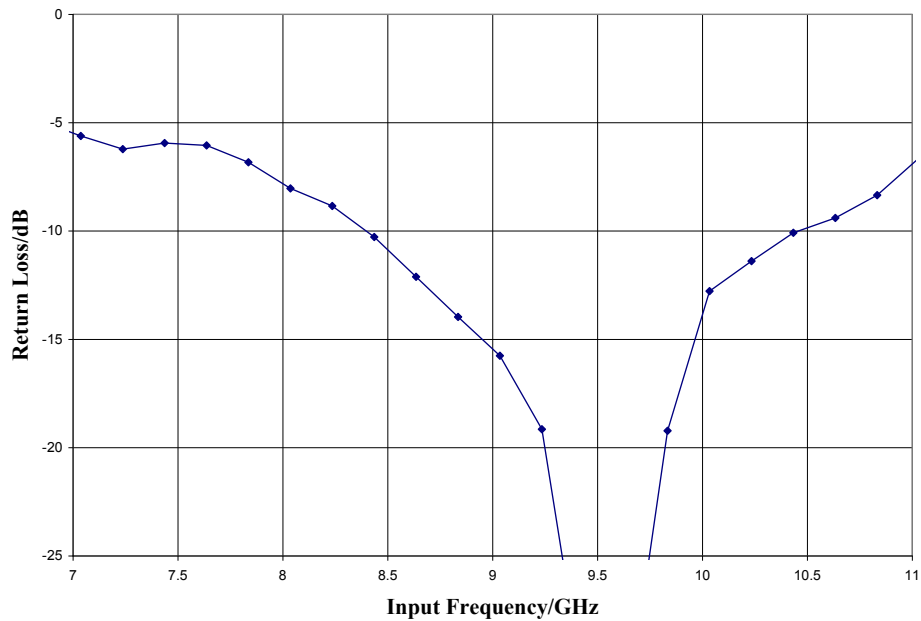

Output Return Loss @ +15 dBm Drive Level, $F = 9\text{ GHz}$ Input, $T_A = 25\text{ }^\circ\text{C}$

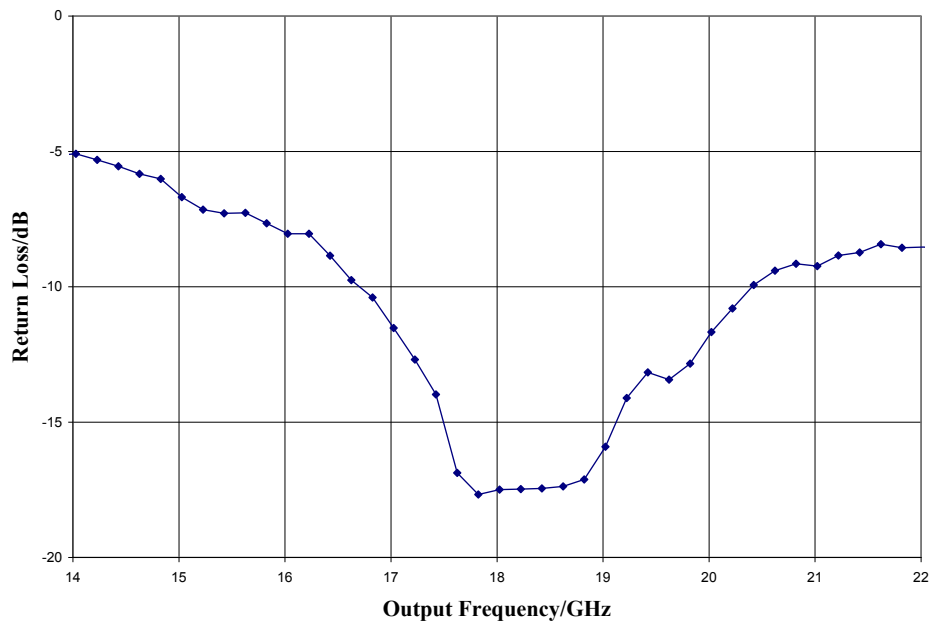

ver 1.1 0817

Mechanical Information

Package Information and Dimensions

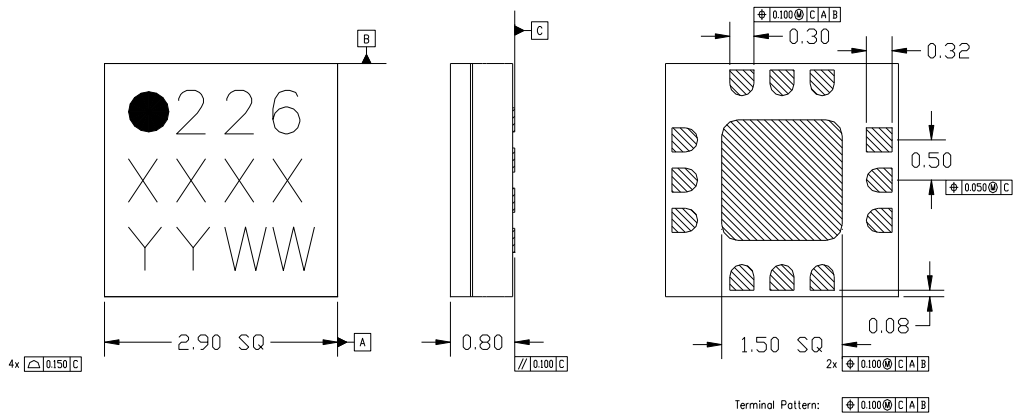

1. ALL DIMENSIONS SHOWN AS mm.
2. MATERIAL: BLACK ALUMINA
3. LEAD FINISH:
 - 3.1 Ni: 8.89um MAX, 1.27um MIN
 - 3.2 Pd: 0.17um MAX, 0.07um MIN
 - 3.3 Au: 0.254um MAX, 0.03um MIN
4. ALTERNATE PIN #1 IDENTIFIER IS SINGLE SQUARE PAD.

Recommended PCB Land Pattern

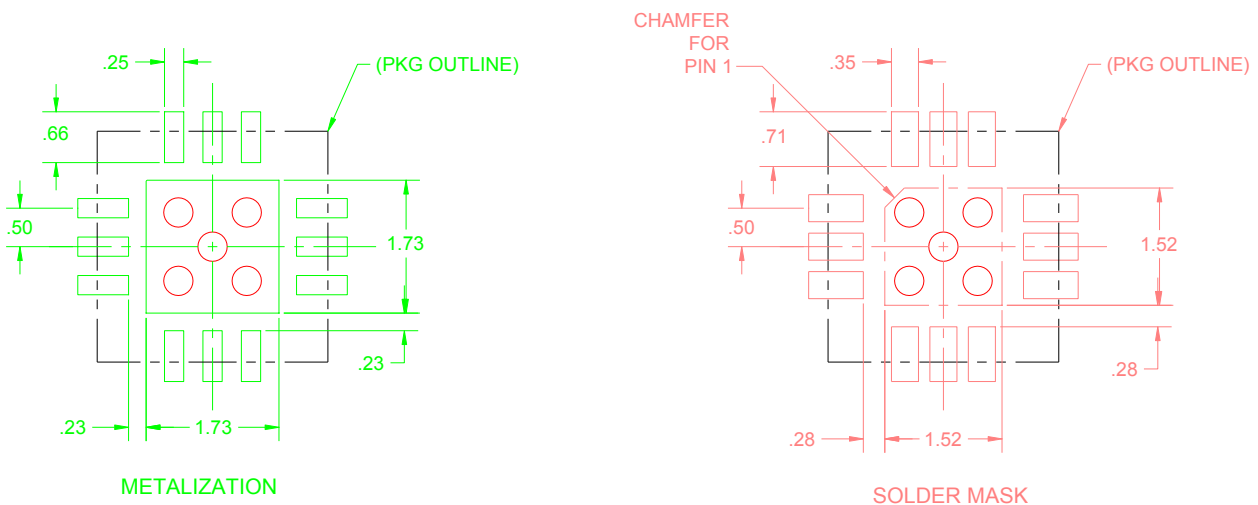



ver 1.1 0817

Pin Description

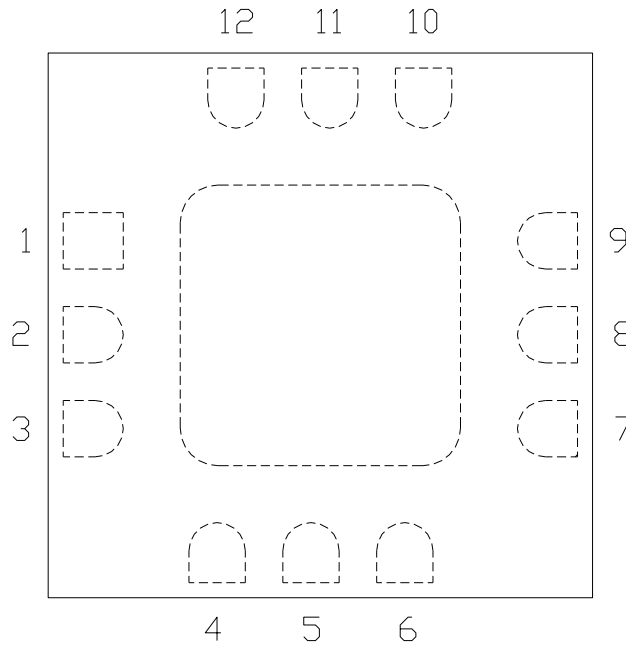
Pin Diagram



Functional Description

Pad	Function	Description	Schematic
1, 3, 7, 9 and die paddle	Ground	Connect to RF / DC ground	
2	RF in	Pin is DC coupled and 50 ohm matched	
4-6, 10-12	N/C	No connection required. These pins may be connected to RF/DC ground	
8	RF out	Pin is DC coupled and 50 ohm matched	

ver 1.1 0817

Applications Information

Evaluation Board

The circuit board shown has been developed for optimized assembly at Custom MMIC. A sufficient number of via holes should be used to connect the top and bottom ground planes. As surface mount processes vary, careful process development is recommended.

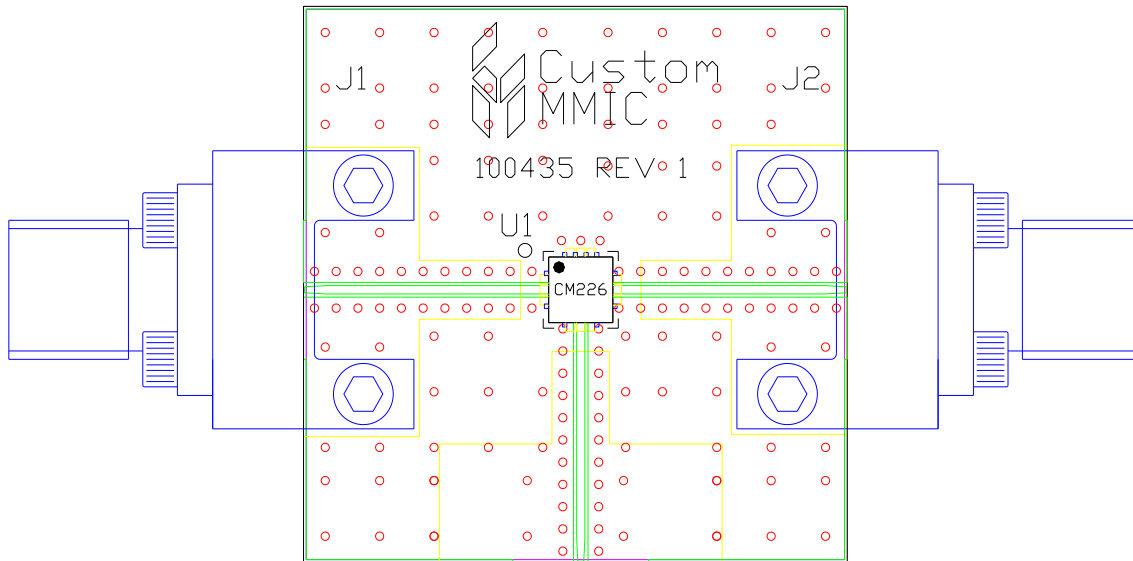

Bill of Material

Designator	Value	Description
J1 - J2		SMA End Launch Connector
U1		CMD226C3 Frequency Doubler
PCB		100435 Evaluation PCB