

Features

- ▶ High gain
- ▶ Low noise figure
- ▶ High linearity
- ▶ High RF power survivability
- ▶ Small die size

Description

The CMD219 is a broadband MMIC GaN low noise amplifier ideally suited for microwave radios and C-band applications where small size and high input power survivability are needed. The broadband device delivers greater than 23 dB of gain with a corresponding output 1 dB compression point of +18 dBm and a noise figure of 1 dB. The CMD219 features a RF input power survivability of greater than 5 Watts. The CMD219 is a 50 ohm matched design eliminating the need for external DC blocks and RF port matching.

Functional Block Diagram

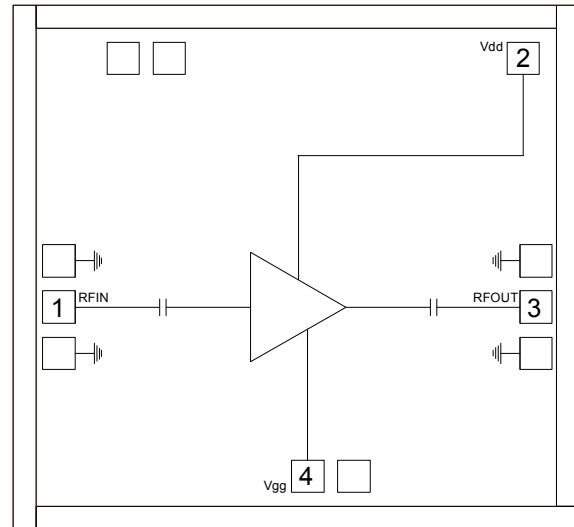

Electrical Performance - $V_{dd} = 10\text{ V}$, $V_{gg} = -2.3\text{ V}$, $T_A = 25\text{ }^\circ\text{C}$, $F = 6\text{ GHz}$

Parameter	Min	Typ	Max	Units
Frequency Range	4 - 8			GHz
Gain		23		dB
Noise Figure		1		dB
Output P1dB		18		dBm
Output Psat		26		dBm
Output IP3		28		dBm
Input Return Loss		15		dB
Output Return Loss		10		dB
Supply Current		75		mA

Specifications

Absolute Maximum Ratings

Parameter	Rating
Drain Voltage, V _{dd}	35 V
RF Input Power	5 W Pulsed
Channel Temperature, T _{ch}	200 °C
Power Dissipation, P _{diss}	3.5 W
Thermal Resistance Θ_{JC}	18.7 °C/W
Operating Temperature	-55 to 85 °C
Storage Temperature	-55 to 150 °C

Exceeding any one or combination of the maximum ratings may cause permanent damage to the device.

Recommended Operating Conditions

Parameter	Min	Typ	Max	Units
V _{dd}	5	10	28	V
I _{dd}		75		mA
V _{gg}	-10		-1	V

Electrical performance is measured at specific test conditions. Electrical specifications are not guaranteed over all recommended operating conditions.

Electrical Specifications - V_{dd} = 10 V, V_{gg} = -2.3 V, T_A = 25 °C

Parameter	Min	Typ	Max	Min	Typ	Max	Units
Frequency Range	5 - 7			4 - 8			GHz
Gain	20	23	27	20	23	28	dB
Noise Figure		1.05	1.4		1.1	1.7	dB
Input Return Loss		15			10		dB
Output Return Loss		10			12		dB
Output P _{1dB}		18			18		dBm
Output IP ₃		28			28		dBm
Supply Current	52	75	98	52	75	98	mA
Gain Temperature Coefficient		0.025			0.025		dB/°C
Noise Figure Temperature Coefficient		0.008			0.008		dB/°C

ver 1.3 0219

Typical Performance

Broadband Performance, $V_{dd} = 10\text{ V}$, $V_{gg} = -2.3\text{ V}$, $I_{dd} = 75\text{ mA}$, $T_A = 25\text{ }^\circ\text{C}$

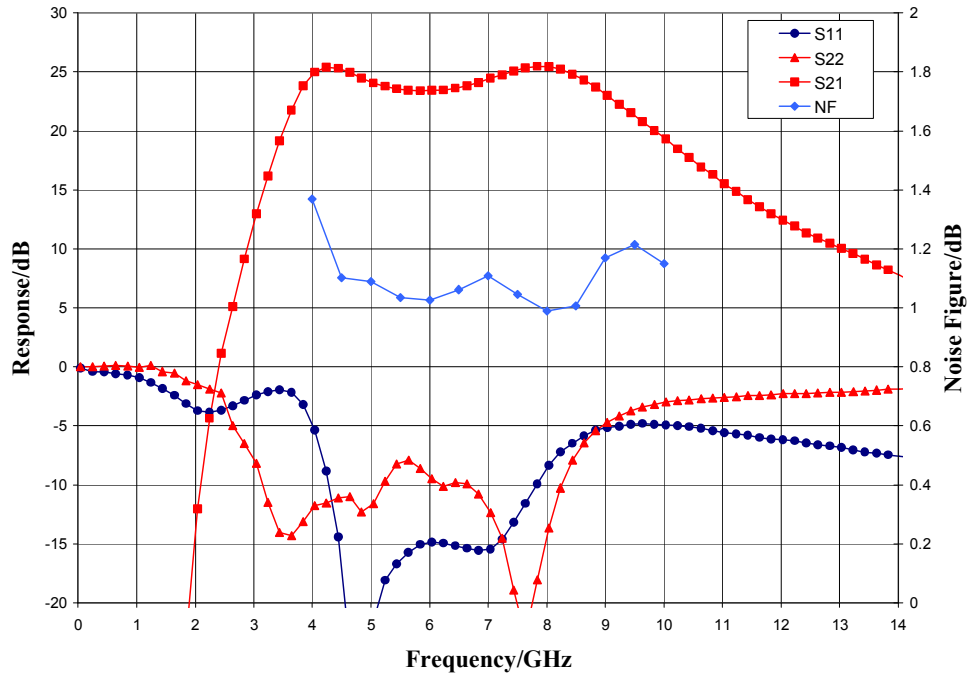

Narrow-band Performance, $V_{dd} = 10\text{ V}$, $V_{gg} = -2.3\text{ V}$, $I_{dd} = 75\text{ mA}$, $T_A = 25\text{ }^\circ\text{C}$

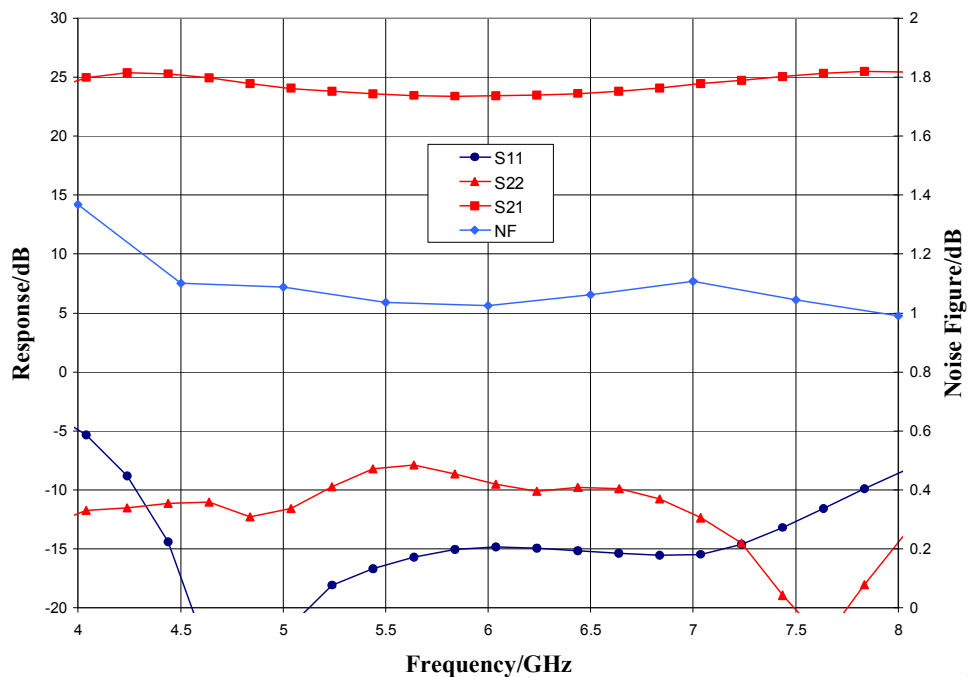

ver 1.3 0219

Typical Performance

Gain vs. Temperature, $V_{dd} = 10\text{ V}$, $V_{gg} = -2.3\text{ V}$

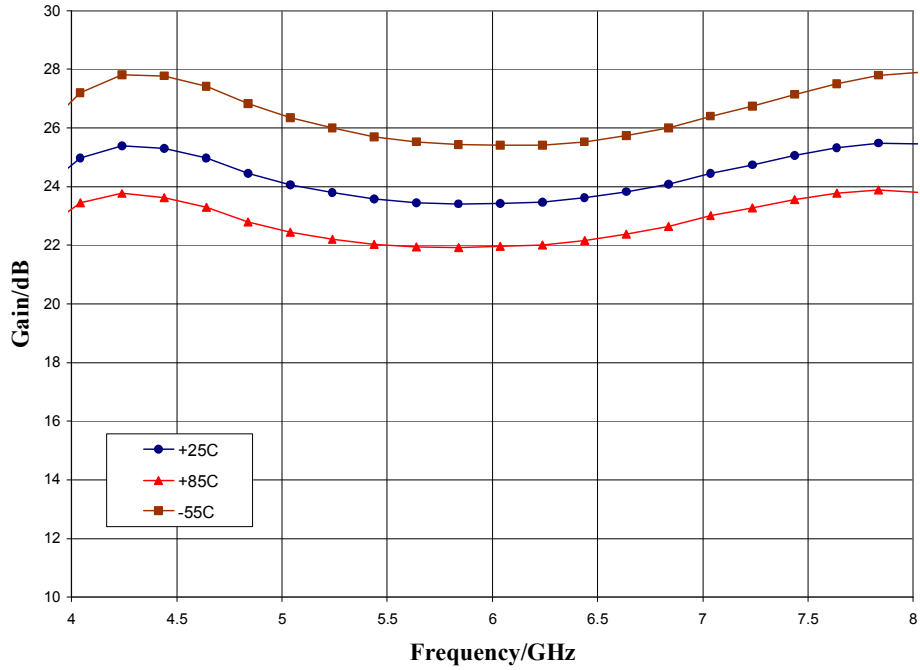

Gain vs. V_{dd} , $V_{gg} = -2.3\text{ V}$, $T_A = 25\text{ }^\circ\text{C}$

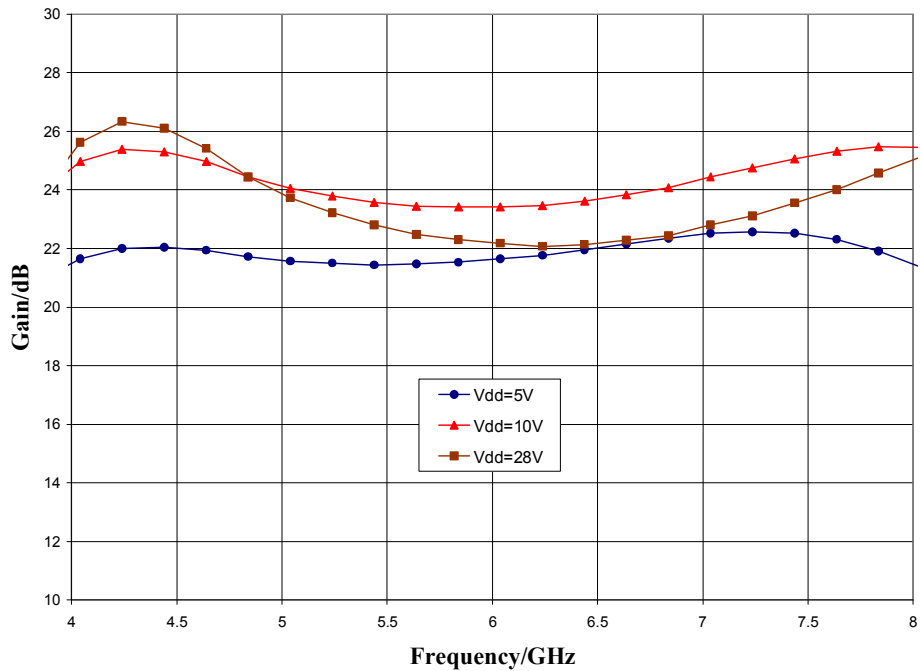

ver 1.3 0219

Typical Performance

Noise Figure vs. Temperature, $V_{dd} = 10\text{ V}$, $V_{gg} = -2.3\text{ V}$

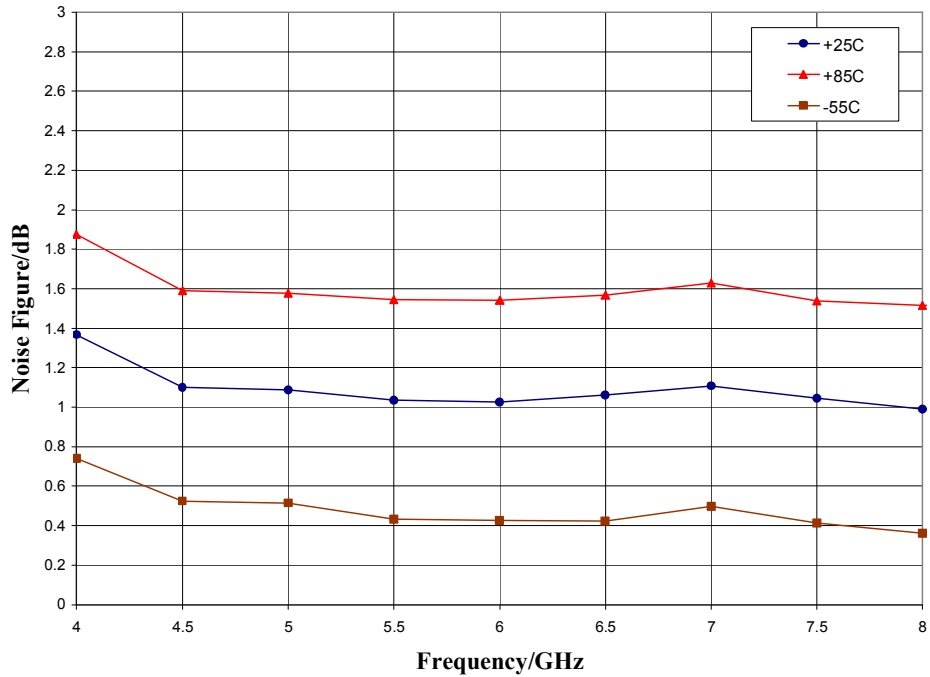

Noise Figure vs. V_{dd} , $V_{gg} = -2.3\text{ V}$, $T_A = 25\text{ }^\circ\text{C}$

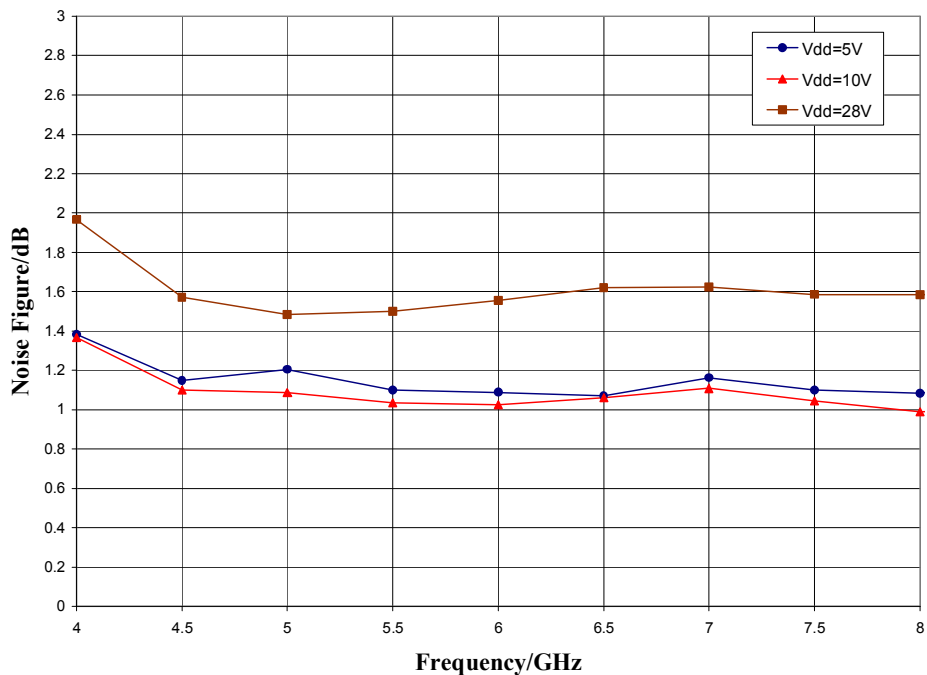

ver 1.3 0219

Typical Performance

Output Power, $V_{dd} = 10\text{ V}$, $V_{gg} = -2.3\text{ V}$, $T_A = 25\text{ }^\circ\text{C}$

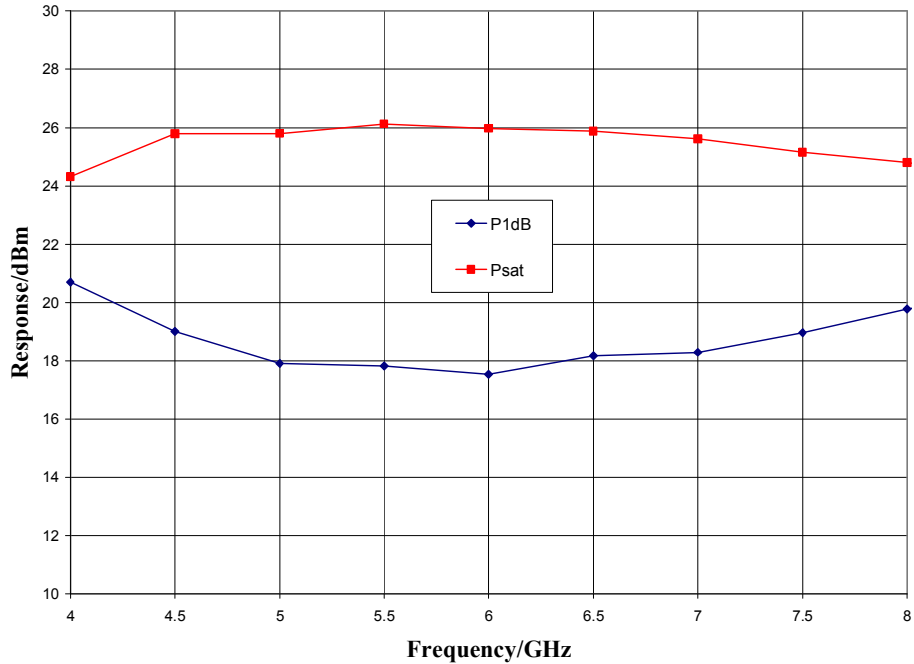

P1dB vs. Temperature, $V_{dd} = 10\text{ V}$, $V_{gg} = -2.3\text{ V}$

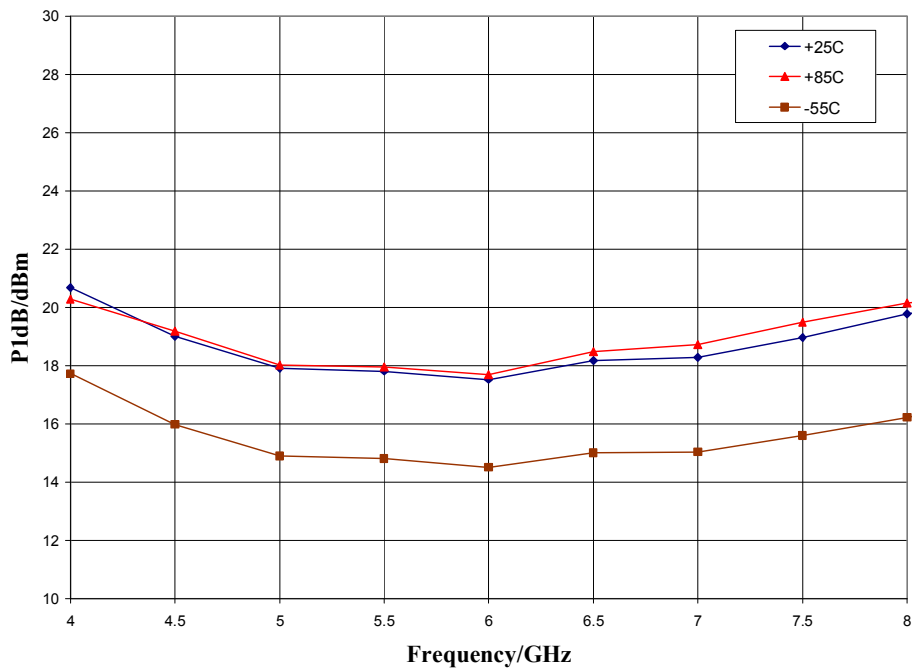

ver 1.3 0219

Typical Performance

P1dB vs. V_{dd} , $V_{gg} = -2.3$ V, $T_A = 25$ °C

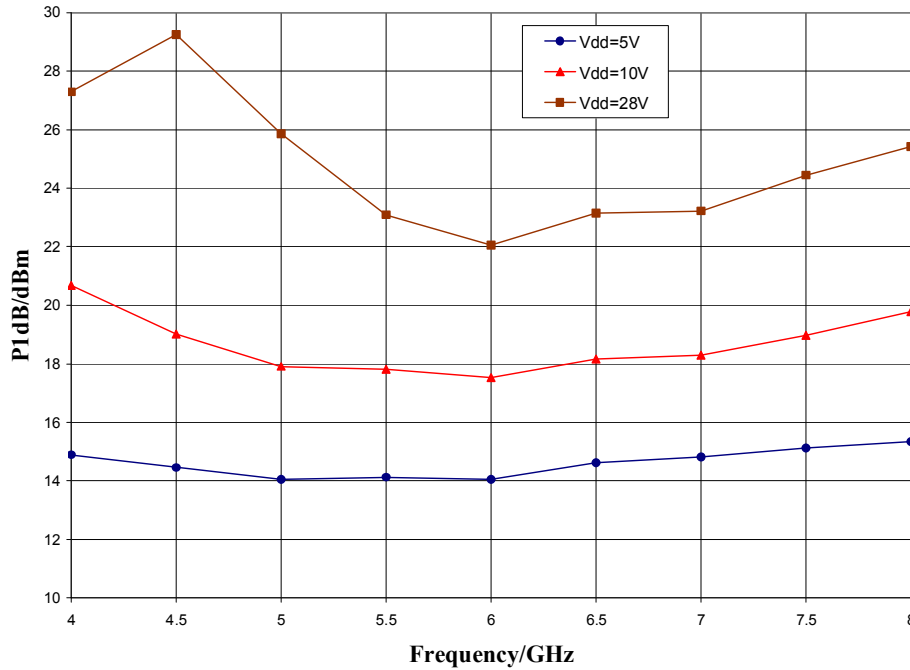

Output IP3 vs. Temperature, $V_{dd} = 10$ V, $V_{gg} = -2.3$ V

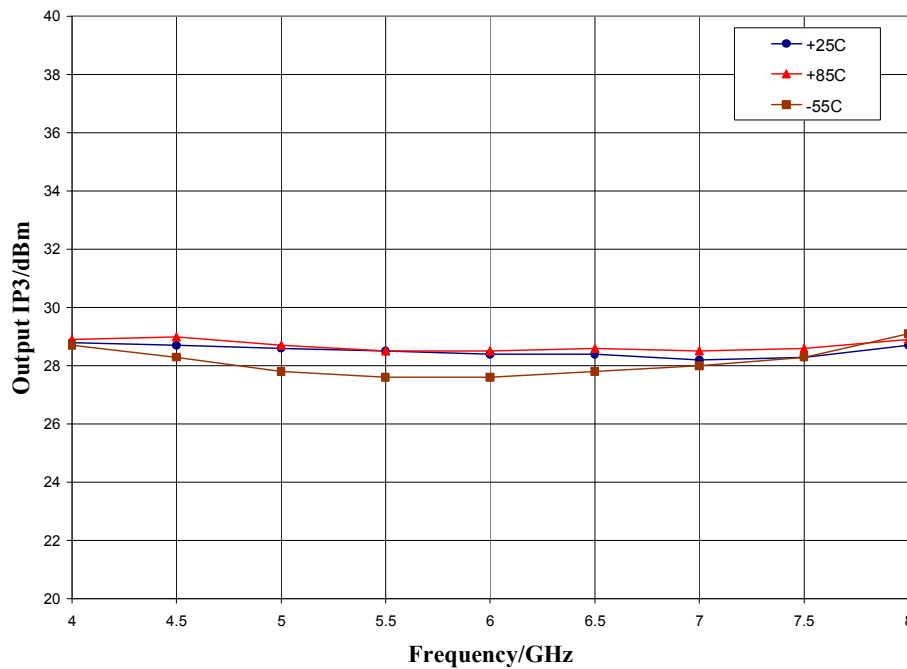

ver 1.3 0219

Typical Performance

Output IP3 vs. V_{dd} , $V_{gg} = -2.3$ V, $T_A = 25$ °C

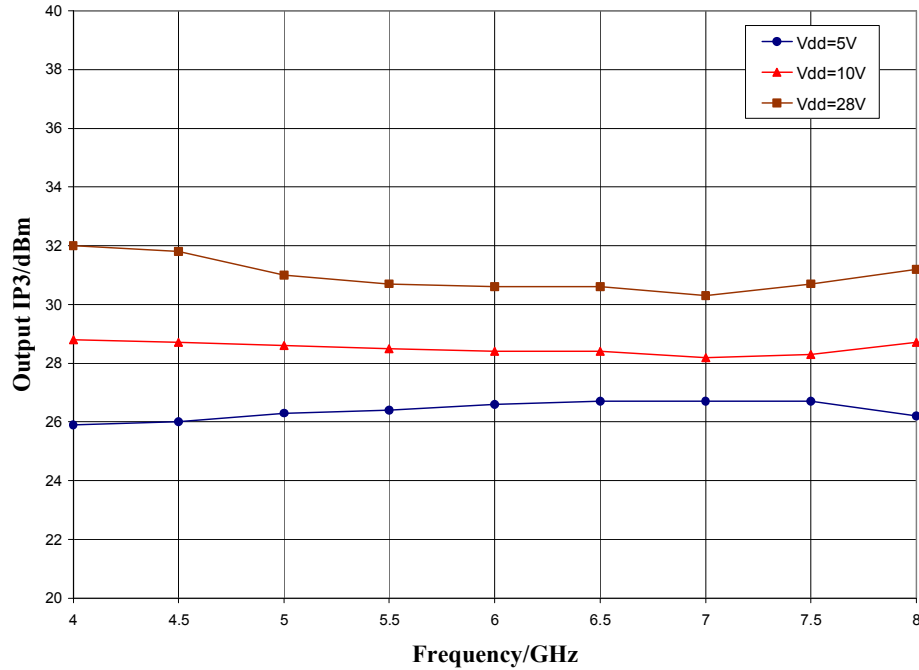

Mechanical Information

Die Outline (all dimensions in microns)

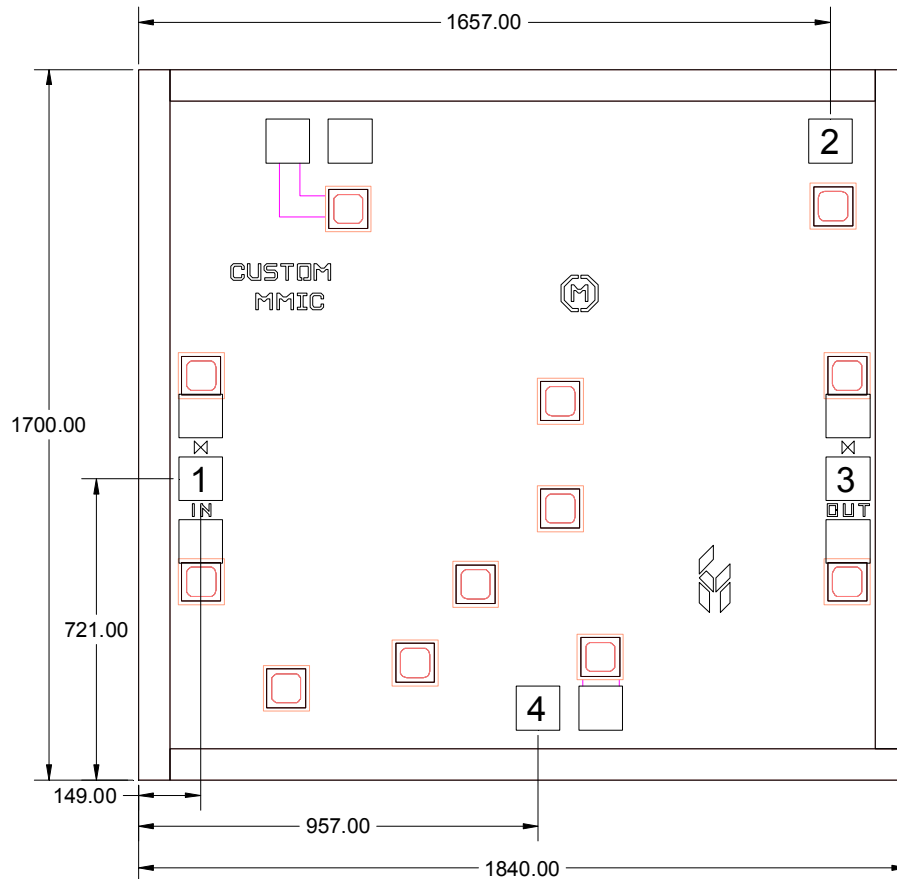

Notes:



1. No connection required for unlabeled pads
2. Backside is RF and DC ground
3. Backside and bond pad metal: Gold
4. Die is 100 microns thick
5. DC bond pads (2, 4) are 100 x 100 microns
6. RF bond pads (1, 3) are 100 x 100 microns

Pin Description

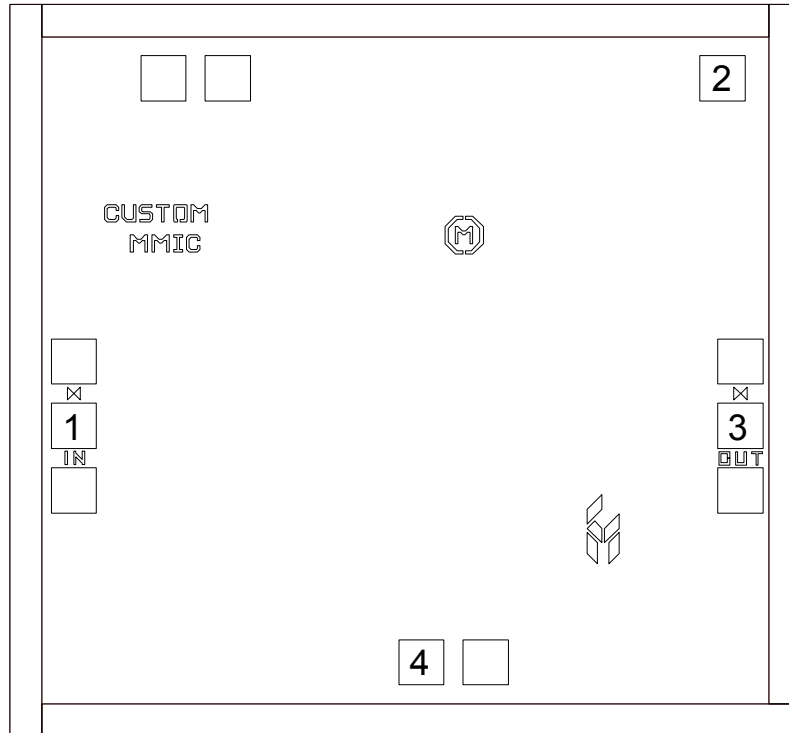
Pad Diagram

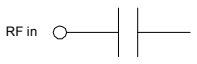
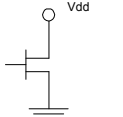
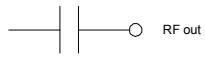
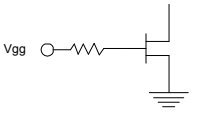

Functional Description

Pad	Function	Description	Schematic
1	RF in	DC blocked and 50 ohm matched	
2	Vdd	Power supply voltage Decoupling and bypass caps required	
3	RF out	DC blocked and 50 ohm matched	
4	Vgg	Power supply voltage Decoupling and bypass caps required	
Backside	Ground	Connect to RF / DC ground	

ver 1.3 0219

Applications Information

Assembly Guidelines

The backside of the CMD219 is RF ground. Die attach should be accomplished with electrically and thermally conductive epoxy or eutectic attach. Standard assembly procedures should be followed for high frequency devices. The top surface of the semiconductor should be made planar to the adjacent RF transmission lines, and the RF decoupling capacitors placed in close proximity to the DC connections on chip.

RF connections should be made as short as possible to reduce the inductive effect of the bond wire. Use of a 0.8 mil thermosonic wedge bonding is highly recommended as the loop height will be minimized. The RF input and output require a single bond wire as shown.

The semiconductor is 100 um thick and should be handled by the sides of the die or with a custom collet. Do not make contact directly with the die surface as this will damage the monolithic circuitry. Handle with care.

Assembly Diagram

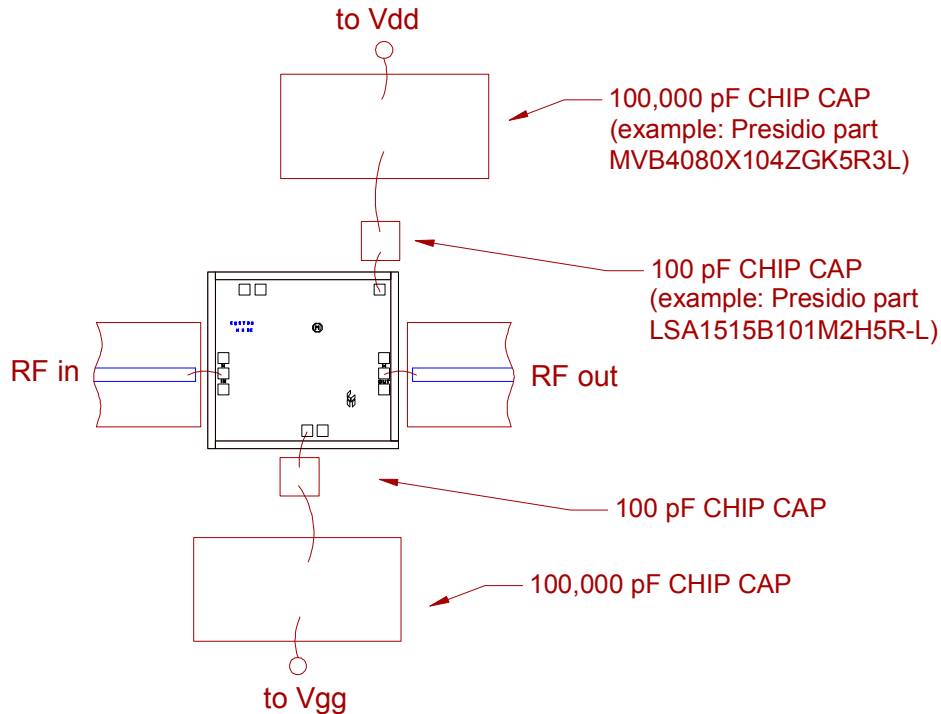

GaAs MMIC devices are susceptible to damage from Electrostatic Discharge. Proper precautions should be observed during handling, assembly and test.

Applications Information

Biasing and Operation

The CMD219 is biased with a positive drain supply and a negative gate supply. Performance is optimized when the drain voltage is set to +10 V but may be set between +5 V and +28 V.

Turn ON procedure:

1. Apply gate voltage V_{gg} and set to a voltage sufficient to pinch off drain current (~ -4 V)
2. Apply drain voltage V_{dd} and set to +10 V
3. Increase V_{gg} (less negative) to achieve a drain current of 75 mA

Turn OFF procedure:

1. Turn off drain voltage V_{dd}
2. Turn off gate voltage V_{gg}

RF power can be applied at any time