

Features

- ▶ High Power
- ▶ High linearity
- ▶ Excellent efficiency
- ▶ Small die size

Description

The CMD216 is a 5.6 W GaN MMIC power amplifier die ideally suited for Ku-band communications systems where high power and high linearity are needed. The device delivers greater than 16 dB of gain with a corresponding output 1 dB compression point of +37 dBm and a saturated output power of +38 dBm at 32% power added efficiency. The CMD216 is a 50 ohm matched design eliminating the need for external DC blocks and RF port matching. The CMD216 offers full passivation for increased reliability and moisture protection.

Functional Block Diagram

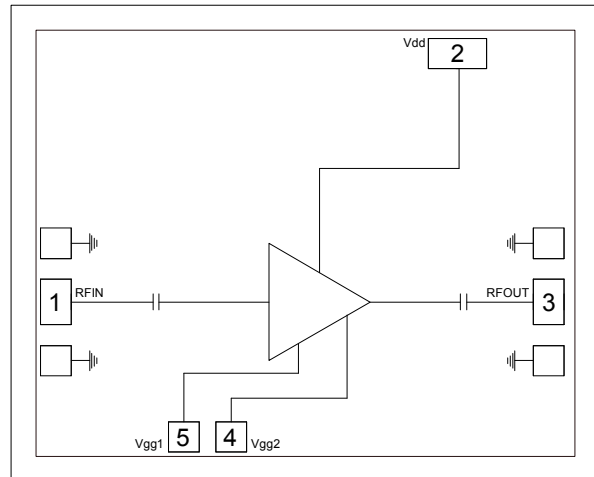

Electrical Performance - $V_{dd} = 28\text{ V}$, $V_{gg1} = V_{gg2} = -3.4\text{ V}$, $T_A = 25\text{ }^\circ\text{C}$, $F = 16\text{ GHz}$

Parameter	Min	Typ	Max	Units
Frequency Range	14 - 18			GHz
Gain		16		dB
Output P1dB		37		dBm
Output Psat		38		dBm
Input Return Loss		10		dB
Output Return Loss		15		dB
Supply Current		550		mA

Specifications

Absolute Maximum Ratings

Parameter	Rating
Drain Voltage, Vdd	
Gate Voltage, Vgg1, 2	
RF Input Power	
Channel Temperature, Tch	
Power Dissipation, P _{diss}	
Thermal Resistance	
Operating Temperature	-55 to 85 °C
Storage Temperature	-55 to 150 °C

Operation of this device outside the maximum ratings may cause permanent damage.

Recommended Operating Conditions

Parameter	Min	Typ	Max	Units
Vdd		28		V
I _{dd}		550		mA
V _{gg1, 2}		-3.4		

Electrical performance is measured at specific test conditions. Electrical specifications are not guaranteed over all recommended operating conditions.

Electrical Specifications - V = 28 V, V_{gg1} = V_{gg2} = -3.4 V, T_A = 25 °C

Parameter	Min	Typ	Max	Units
Frequency Range	14 - 18			GHz
Gain		16		dB
Input Return Loss		10		dB
Output Return Loss		15		dB
Output P _{1dB}		36.5		dBm
P _{sat}		37.5		dBm
Output IP ₃		43		dBm
Power Added Efficiency		28		%
Supply Current		550		mA

ver 1.3 0616

Typical Performance

Broadband Performance, $V_{dd} = 28\text{ V}$, $V_{gg1} = V_{gg2} = -3.4\text{ V}$, $I_{dd} = 550\text{ mA}$, $T_A = 25\text{ }^\circ\text{C}$

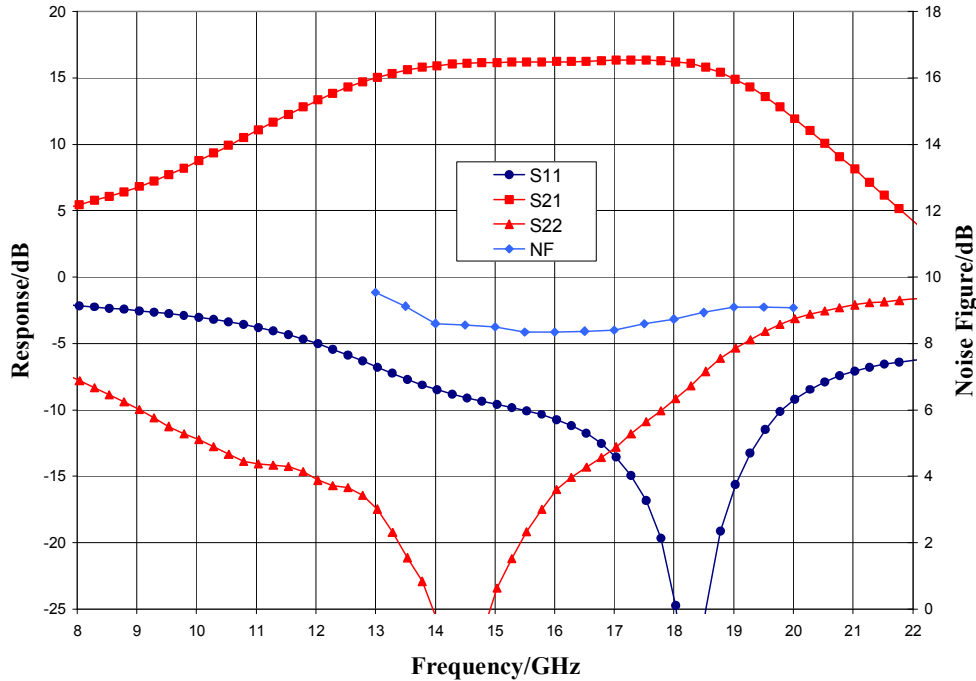

Narrow-band Performance, $V_{dd} = 28\text{ V}$, $V_{gg1} = V_{gg2} = -3.4\text{ V}$, $I_{dd} = 550\text{ mA}$, $T_A = 25\text{ }^\circ\text{C}$

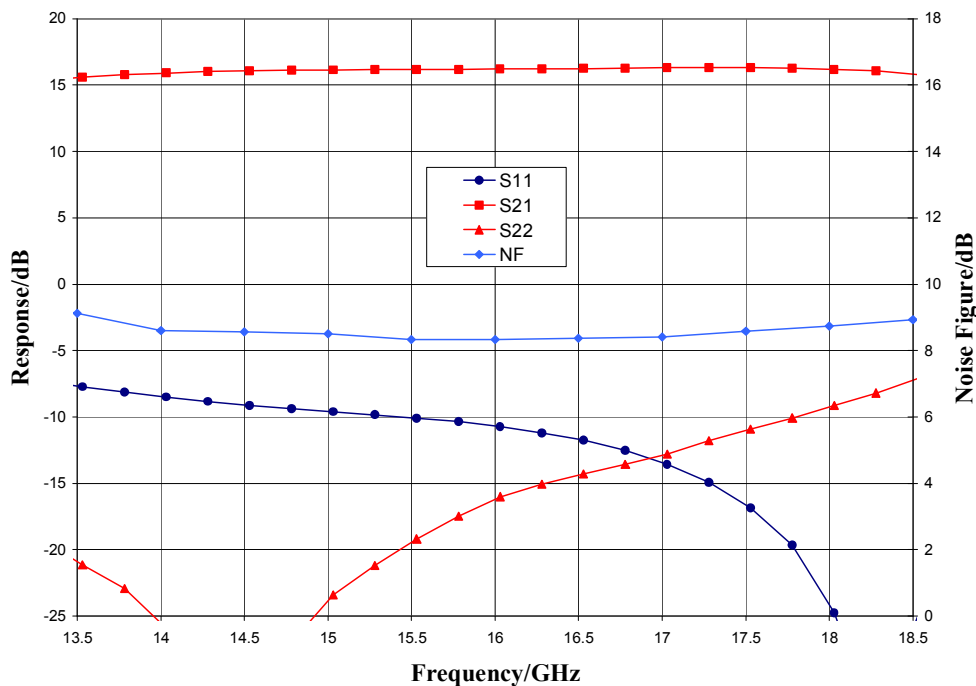

ver 1.3 0616

Typical Performance

Output Power, $V_{dd} = 28\text{ V}$, $V_{gg1} = V_{gg2} = -3.4\text{ V}$, $T_A = 25\text{ }^\circ\text{C}$

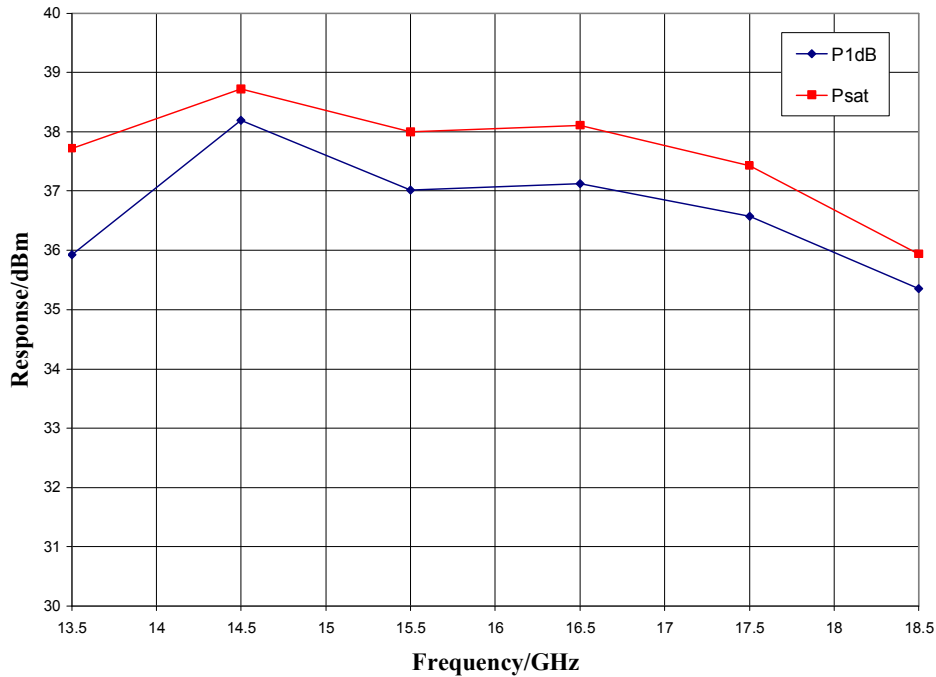

Output IP3, $V_{dd} = 28\text{ V}$, $V_{gg1} = V_{gg2} = -3.4\text{ V}$, $I_{dd} = 550\text{ mA}$, $T_A = 25\text{ }^\circ\text{C}$

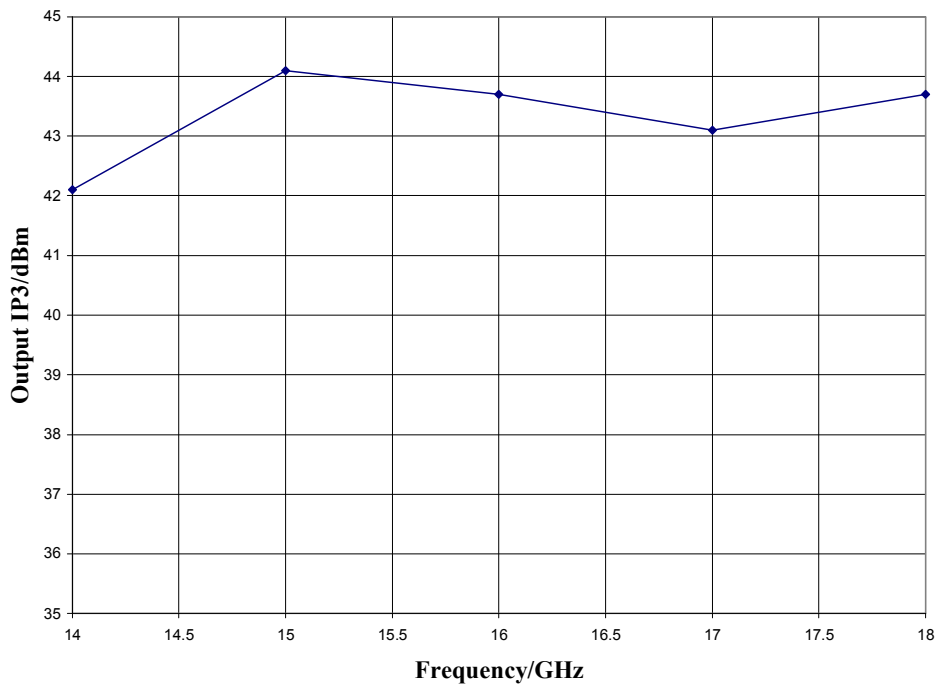

ver 1.3 0616

Mechanical Information

Die Outline (all dimensions in microns)

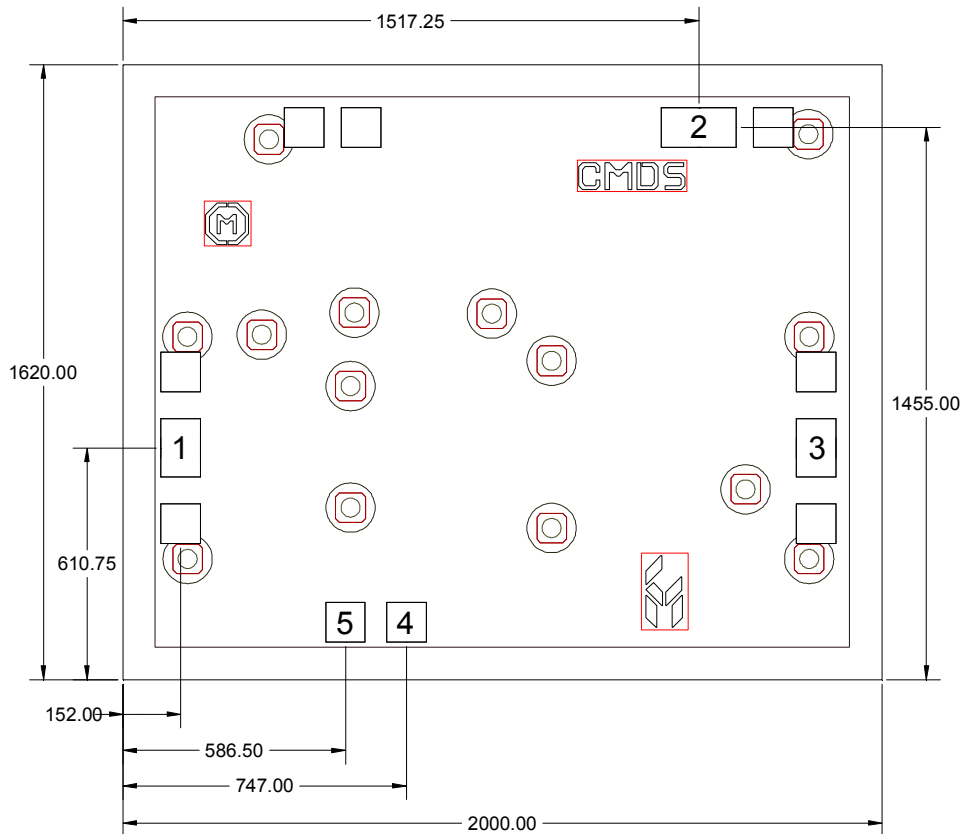

Notes:



1. No connection required for unlabeled pads
2. Backside is RF and DC ground
3. Backside and bond pad metal: Gold
4. Die is 85 microns thick
5. DC bond pads are 100 microns square

Pin Description

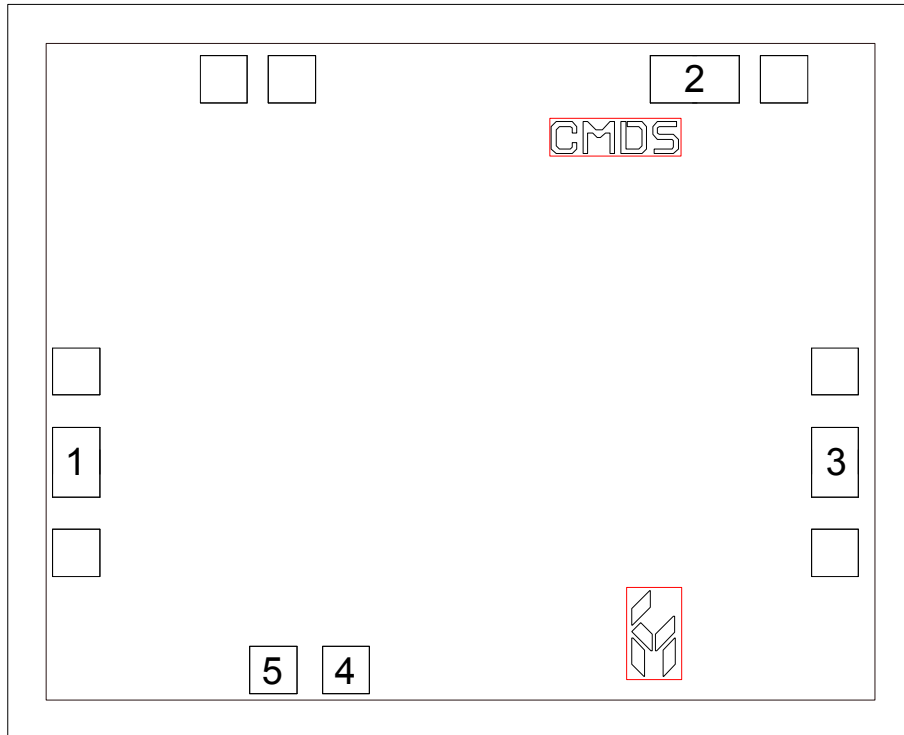
Pad Diagram

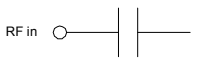
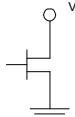
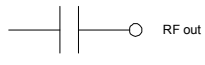
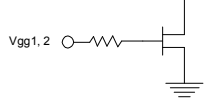

Functional Description

Pad	Function	Description	Schematic
1	RF in	DC blocked and 50 ohm matched	
2	Vdd	Power supply voltage Decoupling and bypass caps required	
3	RF out	DC blocked and 50 ohm matched	
4, 5	Vgg2, 1	Power supply voltage Decoupling and bypass caps required	
Backside	Ground	Connect to RF / DC ground	

ver 1.3 0616

Applications Information

Assembly Guidelines

The backside of the CMD216 is RF ground. Die attach should be accomplished with electrically and thermally conductive epoxy or eutectic attach. Standard assembly procedures should be followed for high frequency devices. The top surface of the semiconductor should be made planar to the adjacent RF transmission lines, and the RF decoupling capacitors placed in close proximity to the DC connections on chip.

RF connections should be made as short as possible to reduce the inductive effect of the bond wire. Use of a 0.8 mil thermosonic wedge bonding is highly recommended as the loop height will be minimized. The RF input and output require a double bond wire as shown.

The semiconductor is 85 um thick and should be handled by the sides of the die or with a custom collet. Do not make contact directly with the die surface as this will damage the monolithic circuitry. Handle with care.

Assembly Diagram

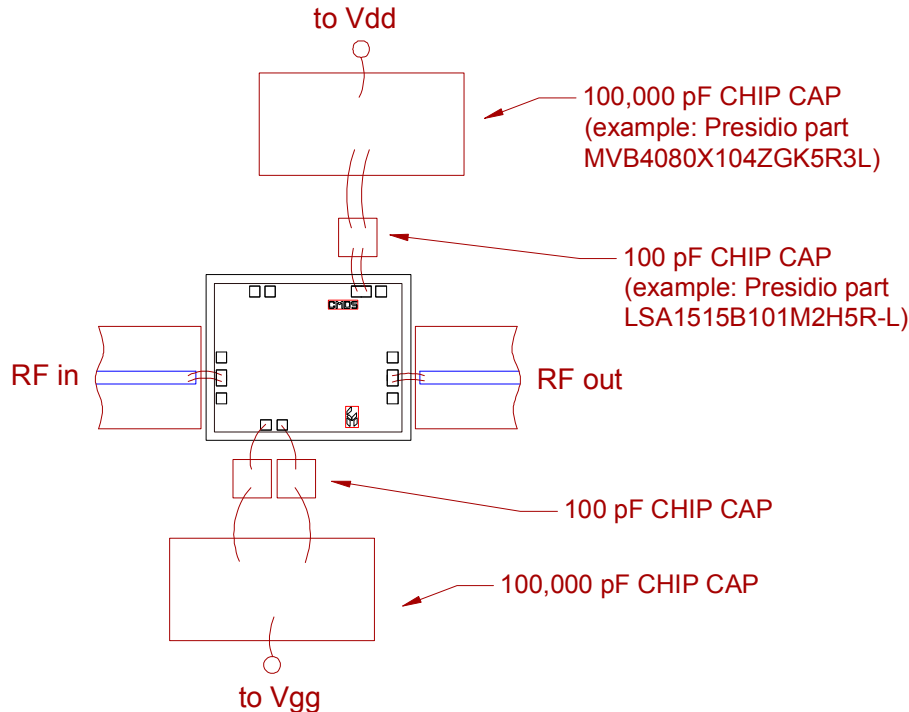

GaAs MMIC devices are susceptible to damage from Electrostatic Discharge. Proper precautions should be observed during handling, assembly and test.

ver 1.3 0616

*Applications Information***Biasing and Operation**

The CMD216 is biased with a positive drain supply and a negative gate supply. Performance is optimized when the drain voltage is set to +28.0 V and the gate voltage is set to -3.4 V.

Turn ON procedure:

1. Apply gate voltage V_{gg1} , V_{gg2} and set to -3.4 V
2. Apply drain voltage V_{dd} and set to +28 V

Turn OFF procedure:

1. Turn off drain voltage V_{dd}
2. Turn off gate voltage V_{gg1} , V_{gg2}

RF power can be applied at any time.