

Features

- ▶ High output power
- ▶ Excellent Fo isolation
- ▶ Broadband performance
- ▶ Small die size

Description

The CMD214 die is a broadband MMIC GaAs x2 active frequency multiplier. When driven by a +13dBm signal, the multiplier provides +17 dBm output power from 24 to 36 GHz. The Fo and 3Fo isolations are >32 dBc and >25 dBc respectively at 26 GHz. The CMD214 is a 50 ohm matched design eliminating the need for external DC blocks and RF port matching.

Functional Block Diagram

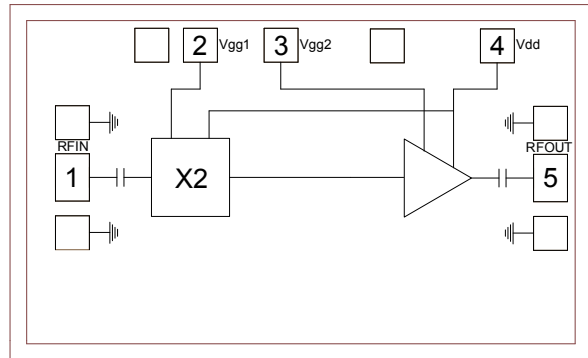

Electrical Performance - $V_{dd} = 5\text{ V}$, $V_{gg1} = -1.8\text{ V}$, $V_{gg2} = -0.7\text{ V}$, $T_A = 25\text{ }^\circ\text{C}$, $P_{in} = 13\text{ dBm}$

Parameter	Min	Typ	Max	Units
Frequency Range, Input	12 - 18			GHz
Frequency Range, Output	24 - 36			GHz
Output Power		17		dBm
Fo Isolation (with respect to output level)		32		dBc
3Fo Isolation (with respect to output level)		25		dBc
Input Return Loss		15		dB
Output Return Loss		13		dB
Supply Current		40		mA

Specifications

Absolute Maximum Ratings

Parameter	Rating
Drain Voltage, V _{dd}	6.0 V
RF Input Power	+20 dBm
Channel Temperature, T _{ch}	150 °C
Power Dissipation, P _{diss}	337 mW
Thermal Resistance	192 °C/W
Operating Temperature	-55 to 85 °C
Storage Temperature	-55 to 150 °C

Operation of this device outside the maximum ratings may cause permanent damage.

Recommended Operating Conditions

Parameter	Min	Typ	Max	Units
V _{dd}	3.0	5.0	5.5	V
I _{dd}		40		mA
V _{gg1}		-1.8		V
V _{gg2}		-0.7		V

Electrical performance is measured at specific test conditions. Electrical specifications are not guaranteed over all recommended operating conditions.

Electrical Specifications - V_{dd} = 5 V, V_{gg1} = -1.8 V, V_{gg2} = -0.7 V, T_A = 25 °C, P_{in} = 13 dBm

Parameter	Min	Typ	Max	Units
Frequency Range, Input	12 - 18			GHz
Frequency Range, Output	24 - 36			GHz
Output Power	14	17		dBm
F _o Isolation (with respect to output level)	27	32		dBc
3F _o Isolation (with respect to output level)		25		dBc
Input Return Loss		15		dB
Output Return Loss		13		dB
Supply Current		40		mA

ver 1.1 0616

Typical Performance

Output Power vs. Temperature @ 13 dBm Drive Level

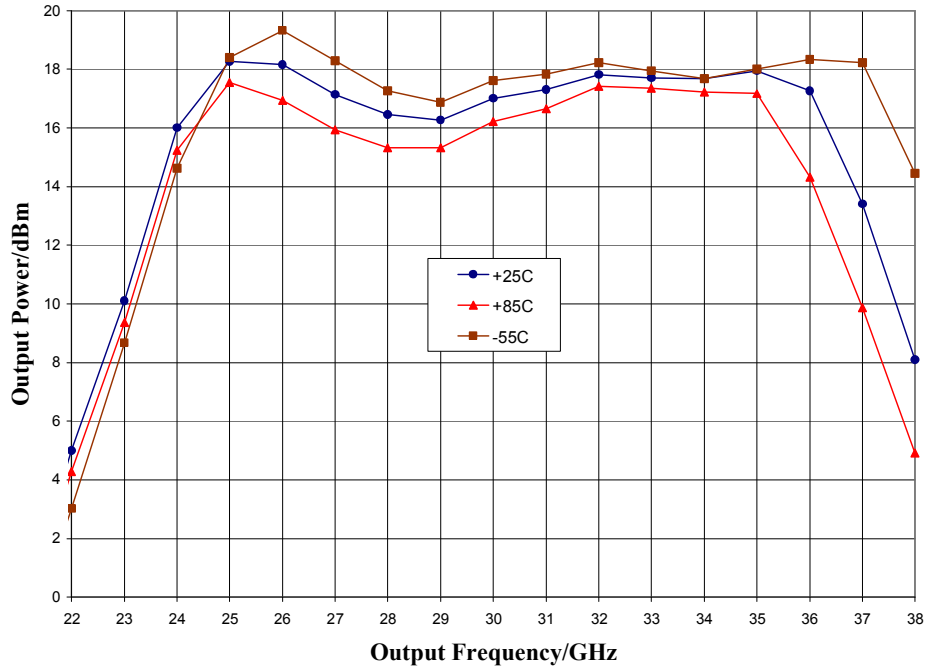

Output Power vs. Drive Level, T_A = 25 °C

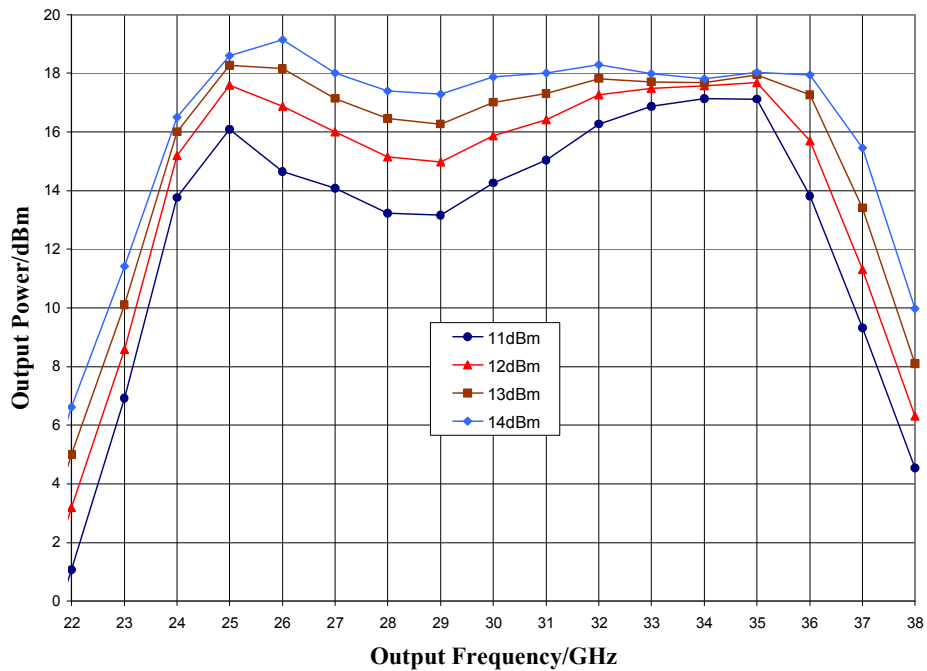

ver 1.1 0616

Typical Performance

Output Power vs. Input Power, $T_A = 25\text{ }^\circ\text{C}$

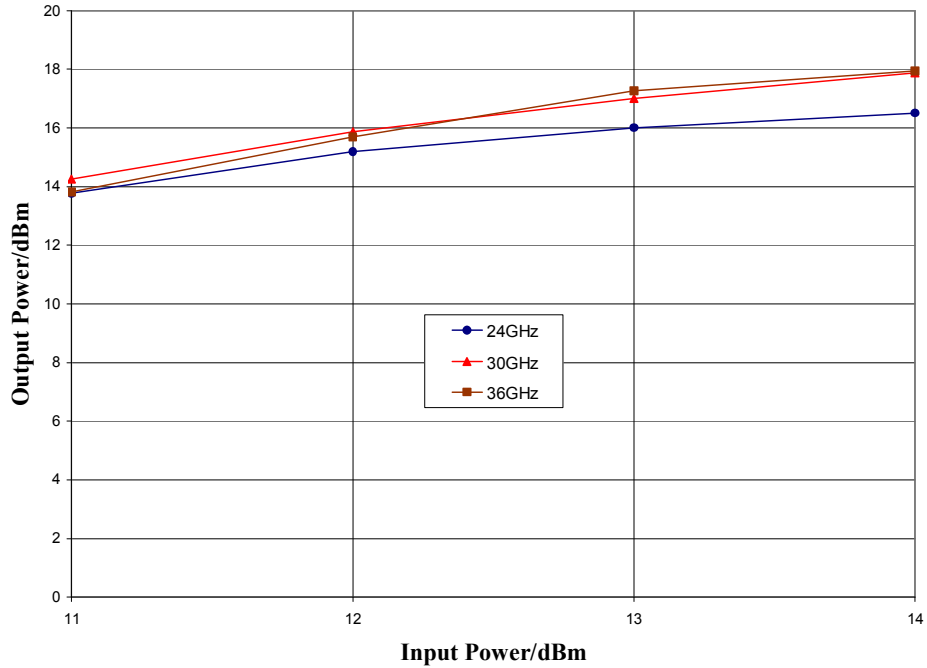

Isolation @ 13 dBm Drive Level, $T_A = 25\text{ }^\circ\text{C}$

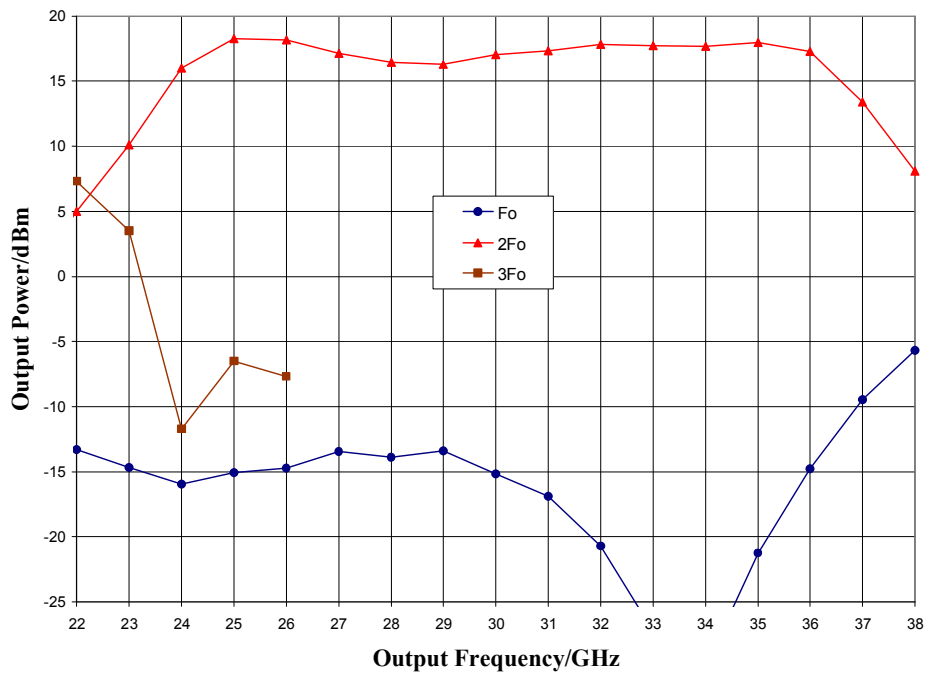

ver 1.1 0616

Typical Performance

Input Return Loss vs. Drive Level, $T_A = 25\text{ }^\circ\text{C}$

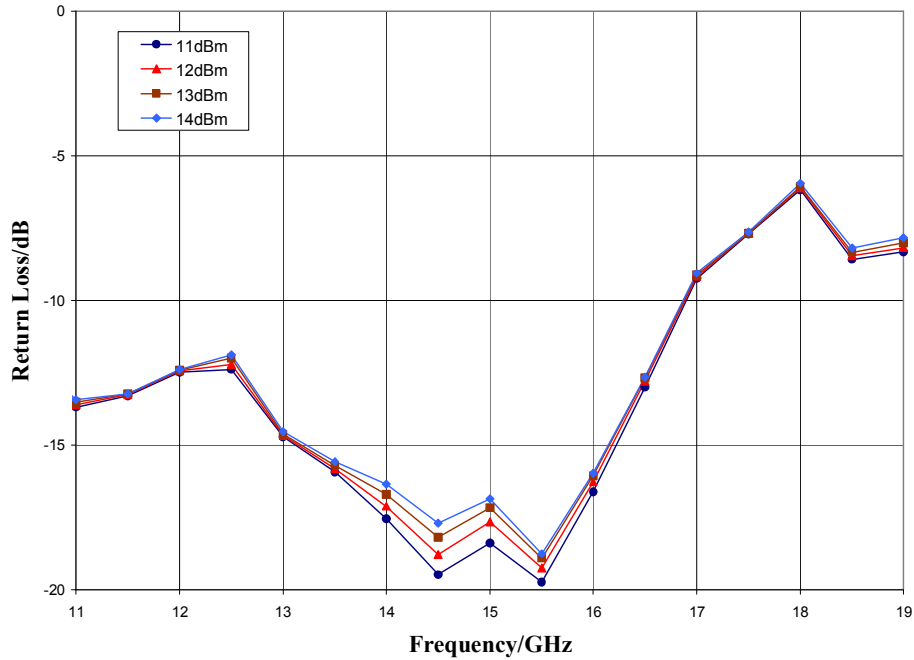

Output Return Loss, $T_A = 25\text{ }^\circ\text{C}$

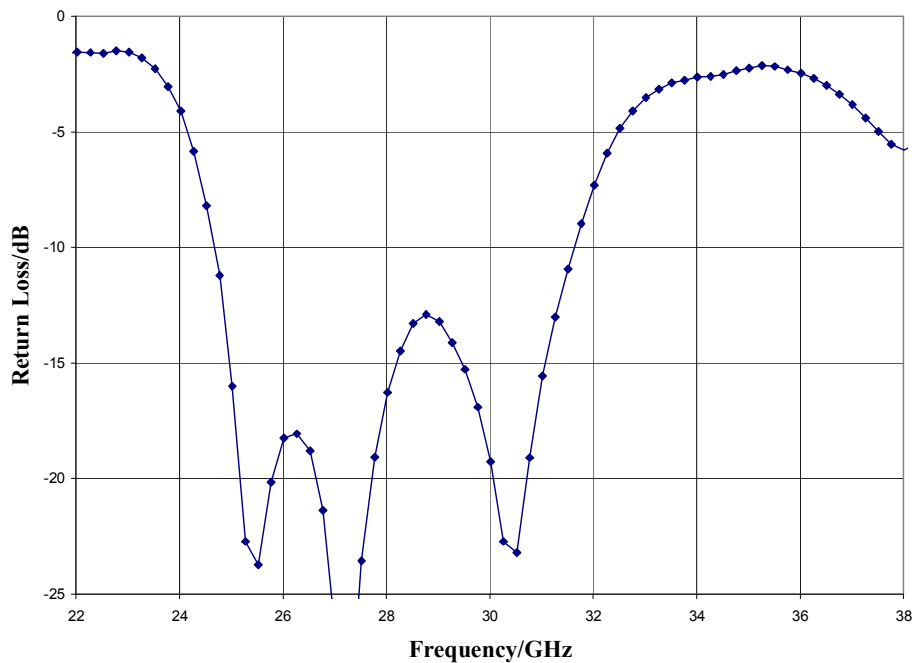

ver 1.1 0616

Mechanical Information

Die Outline (all dimensions in microns)

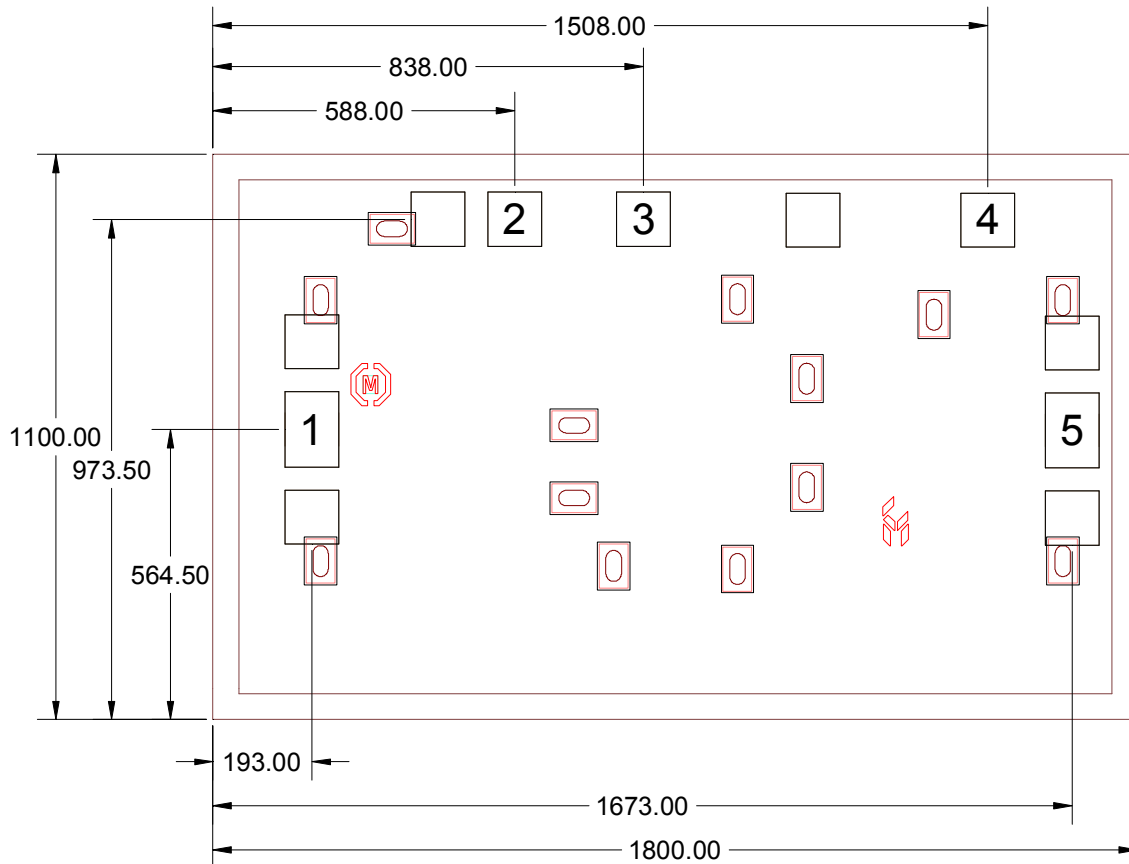

Notes:



1. No connection required for unlabeled pads
2. Backside is RF and DC ground
3. Backside and bond pad metal: Gold
4. Die is 100 microns thick
5. DC bond pads are 100 microns square

Pin Description

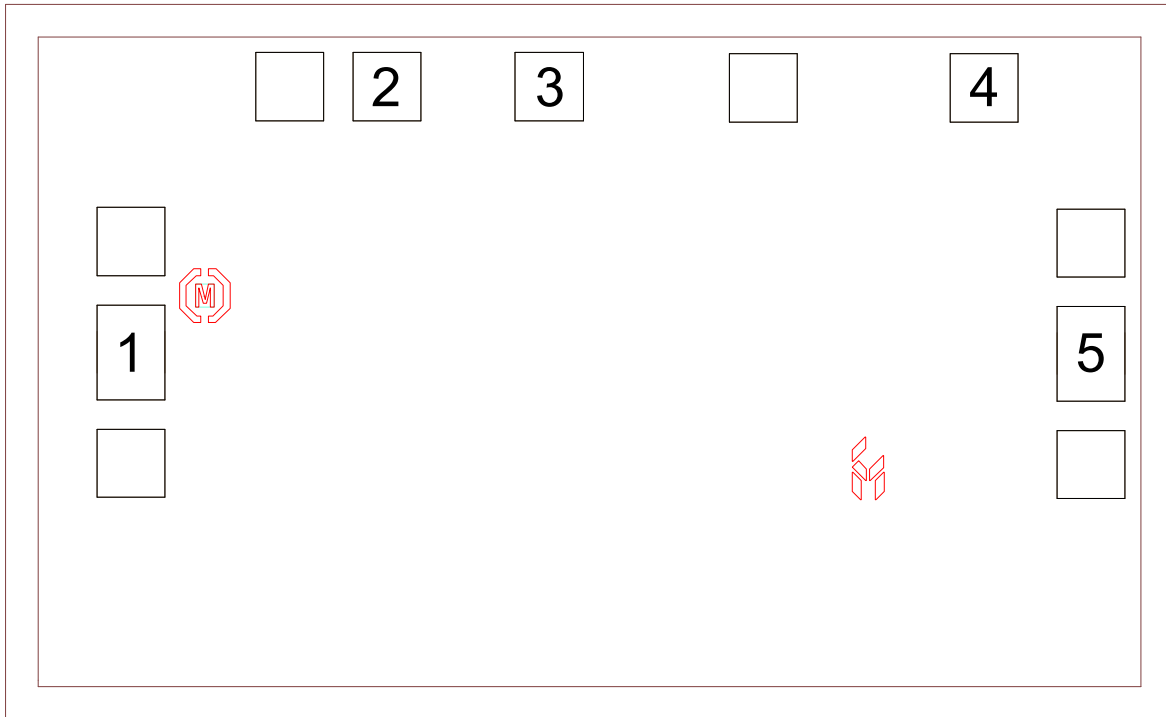
Pad Diagram

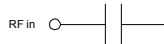
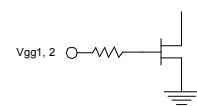
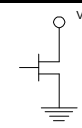

Functional Description

Pad	Function	Description	Schematic
1	RF in	DC blocked and 50 ohm matched	
2, 3	V _{gg1, 2}	Power supply voltage Decoupling and bypass caps required	
4	V _{dd}	Power supply voltage Decoupling and bypass caps required	
5	RF out	DC blocked and 50 ohm matched	
Backside	Ground	Connect to RF / DC ground	

ver 1.1 0616

Applications Information

Assembly Guidelines

The backside of the CMD214 is RF ground. Die attach should be accomplished with electrically and thermally conductive epoxy or eutectic attach. Standard assembly procedures should be followed for high frequency devices. The top surface of the semiconductor should be made planar to the adjacent RF transmission lines, and the RF decoupling capacitors placed in close proximity to the DC connections on chip.

RF connections should be made as short as possible to reduce the inductive effect of the bond wire. Use of a 0.8 mil thermosonic wedge bonding is highly recommended as the loop height will be minimized. The RF input and output require a single bond wire as shown.

The semiconductor is 100 um thick and should be handled by the sides of the die or with a custom collet. Do not make contact directly with the die surface as this will damage the monolithic circuitry. Handle with care.

Assembly Diagram

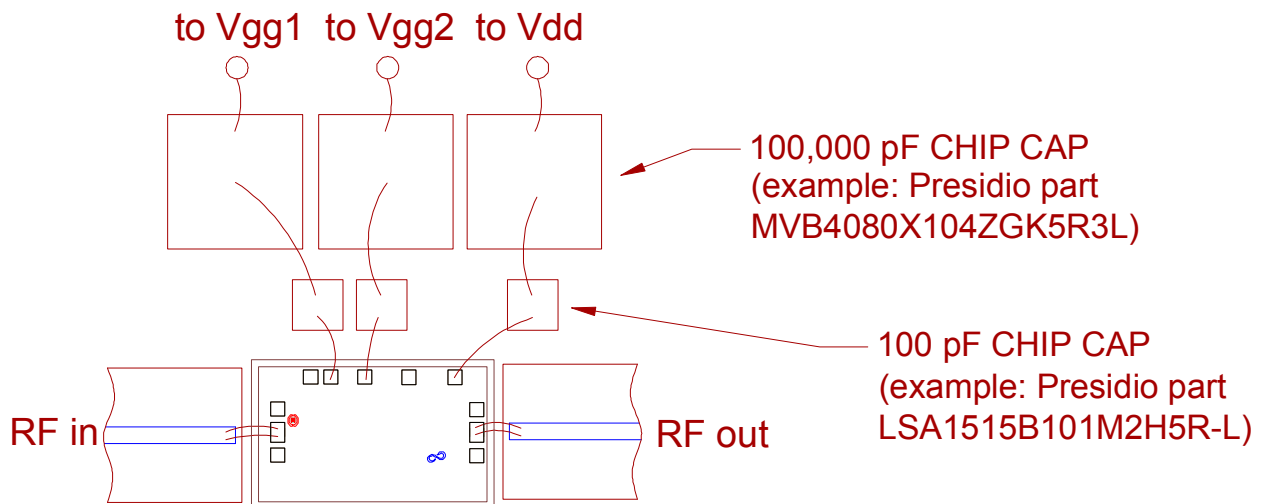

GaAs MMIC devices are susceptible to damage from Electrostatic Discharge. Proper precautions should be observed during handling, assembly and test.

ver 1.1 0616

Applications Information

Biasing and Operation

The CMD214 is biased with a positive drain supply and two negative gate supplies. Performance is optimized when the V_{dd} is set to +5.0 V, V_{gg1} is set to -1.8 V and V_{gg2} is set to -0.7 V.

Turn ON procedure:

1. Apply gate voltages V_{gg1} and V_{gg2} and set to -1.8 V
2. Apply drain voltage V_{dd} and set to +5 V
3. Adjust gate voltage V_{gg2} and set to -0.7 V

Turn OFF procedure:

1. Turn off drain voltage V_{dd}
2. Turn off gate voltages V_{gg1} and V_{gg2}