

Custom MMIC

CMD206

DC-50 GHz Distributed Low Noise Amplifier

Features

- ▶ Ultra wideband performance
- ▶ Low noise figure
- ▶ Low power consumption
- ▶ Excellent return losses
- ▶ Small die size

Description

The CMD206 is wideband GaAs MMIC distributed low noise amplifier die which operates from DC to 50 GHz. The amplifier delivers greater than 11 dB of gain with a corresponding noise figure of 3.5 dB and an output 1 dB compression point of +12 dBm at 30 GHz. The CMD206 is a 50 ohm matched design which eliminates the need for RF port matching. The CMD206 offers full passivation for increased reliability and moisture protection.

Functional Block Diagram

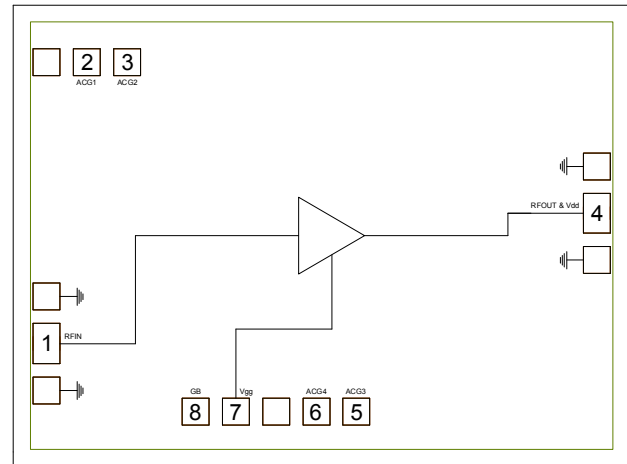

Electrical Performance - $V_{dd} = 4.0\text{ V}$, $V_{gg} = 3.0\text{ V}$, $T_A = 25\text{ }^\circ\text{C}$, $F = 30\text{ GHz}$

Parameter	Min	Typ	Max	Units
Frequency Range	DC - 50			GHz
Gain		11		dB
Noise Figure		3.5		dB
Input Return Loss		20		dB
Output Return Loss		10		dB
Output P1dB		12		dBm
Supply Current		32		mA

ver 1.2 0616



CMD206

DC-50 GHz Distributed Low Noise Amplifier

Specifications

Absolute Maximum Ratings

Parameter	Rating
Drain Voltage, V _{dd}	6.0 V
Gate Voltage, V _{gg}	4.0 V
RF Input Power	+20 dBm
Channel Temperature, T _{ch}	150 °C
Power Dissipation, P _{diss}	712 mW
Thermal Resistance	91.2 °C/W
Operating Temperature	-55 to 85 °C
Storage Temperature	-55 to 150 °C

Operation of this device outside the maximum ratings may cause permanent damage.

Recommended Operating Conditions

Parameter	Min	Typ	Max	Units
V _{dd}	3.0	4.0	5.0	V
I _{dd}		32		mA
V _{gg}	0	3.0	3.0	V

Electrical performance is measured at specific test conditions. Electrical specifications are not guaranteed over all recommended operating conditions.

Electrical Specifications, V_{dd} = 4.0 V, V_{gg} = 3.0 V, T_A = 25 °C

Parameter	Min	Typ	Max	Min	Typ	Max	Min	Typ	Max	Units
Frequency Range	DC - 10			10 - 30			30 - 50			GHz
Gain	7	10		7	10		8	12		dB
Noise Figure		4			3.5	4		4.5		dB
Input Return Loss		20			15			10		dB
Output Return Loss		25			15			10		dB
Output P _{1dB}		12.5			13			10		dBm
Output IP ₃		21			22			18		dBm
Supply Current	22	32	42	22	32	42	22	32	42	mA
Gain Temperature Coefficient		0.008			0.012			0.023		dB/°C
Noise Figure Temperature Coefficient		0.008			0.008			0.012		dB/°C

ver 1.2 0616

Typical Performance

Broadband Performance, $V_{dd} = 4\text{ V}$, $V_{gg} = 3\text{ V}$, $I_{dd} = 32\text{ mA}$, $T_A = 25\text{ }^\circ\text{C}$

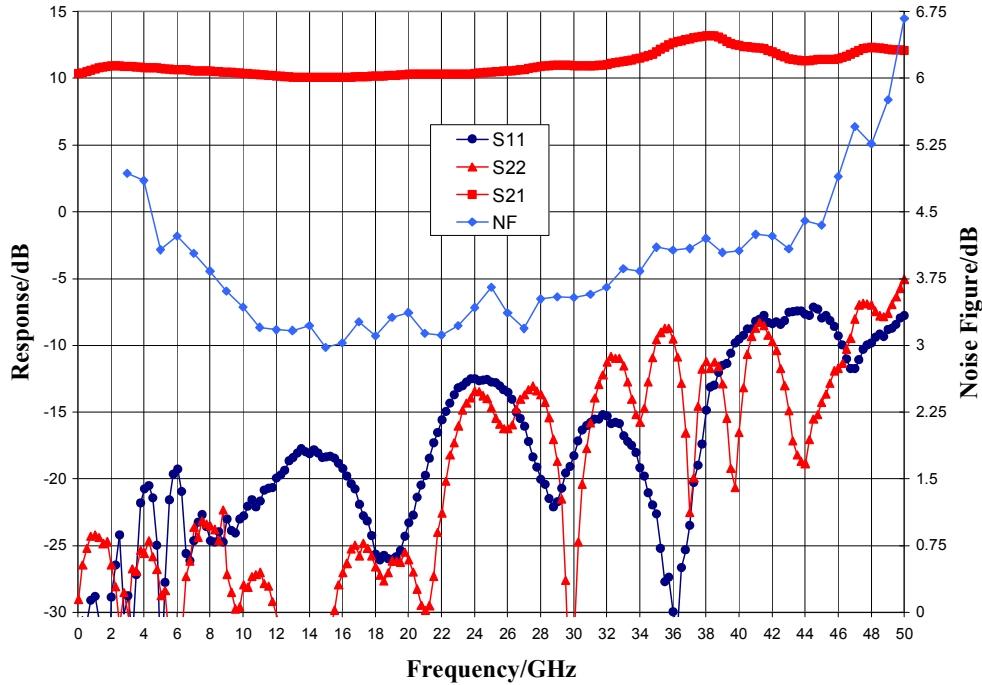

Gain vs. Temperature, $V_{dd} = 4\text{ V}$, $V_{gg} = 3\text{ V}$

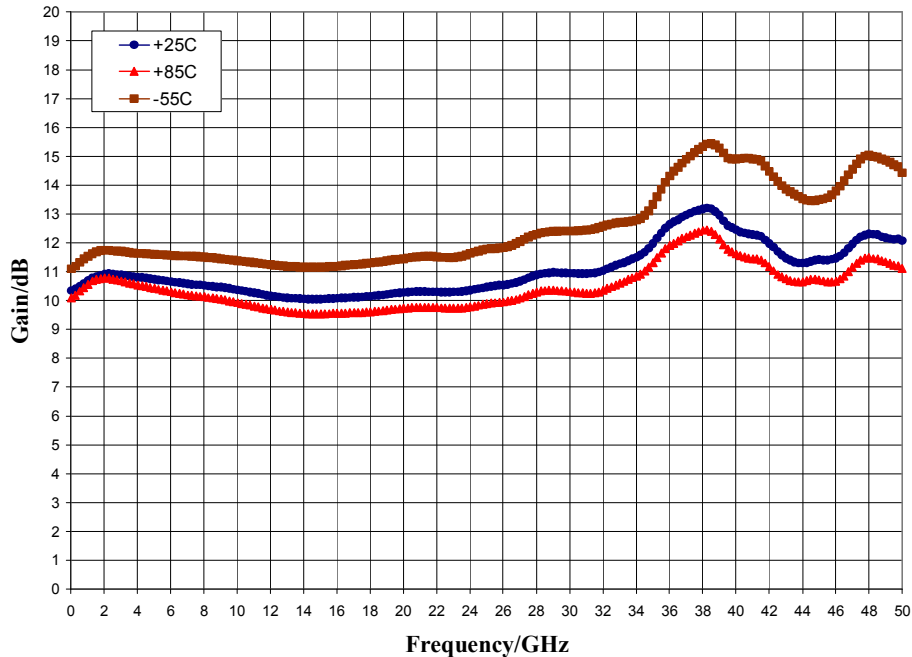

ver 1.2 0616

Typical Performance

Noise Figure vs. Temperature, $V_{dd} = 4\text{ V}$, $V_{gg} = 3\text{ V}$

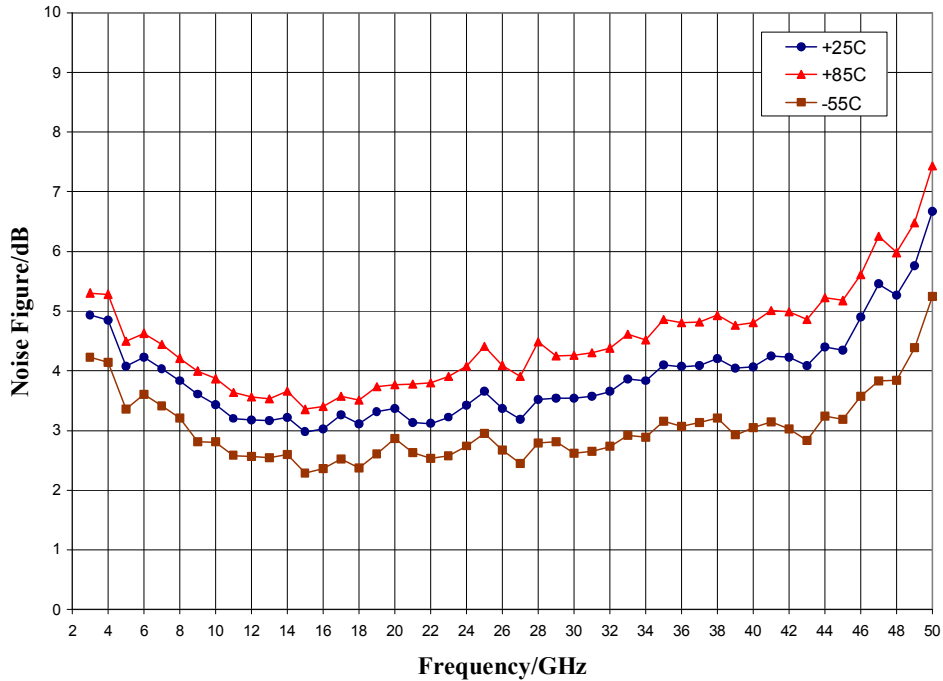

Output Power, $V_{dd} = 4\text{ V}$, $V_{gg} = 3\text{ V}$, $T_A = 25\text{ }^\circ\text{C}$

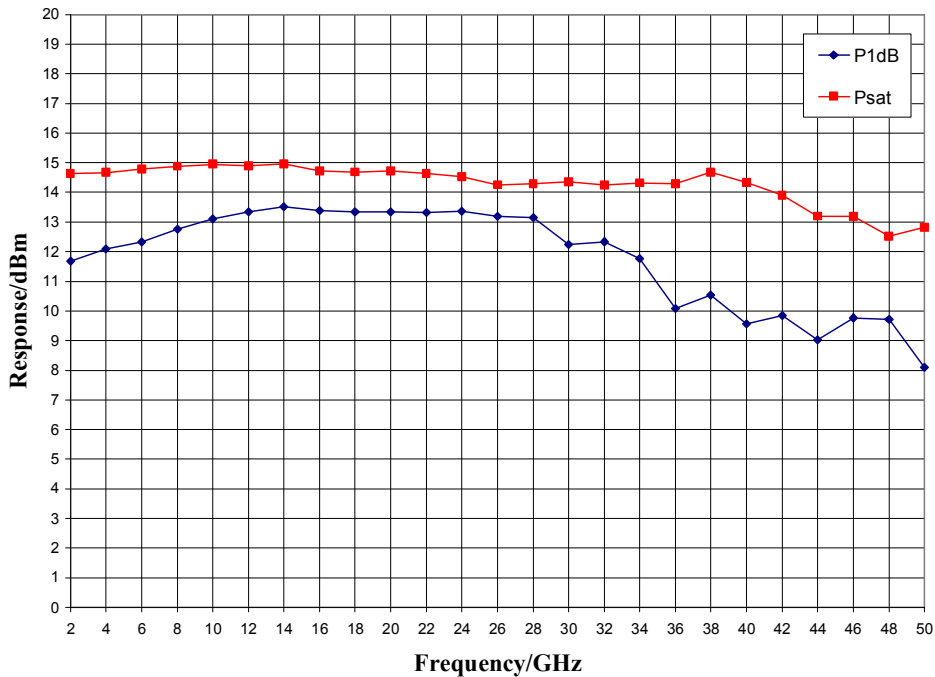

ver 1.2 0616

Typical Performance

P1dB vs. Temperature, $V_{dd} = 4\text{ V}$, $V_{gg} = 3\text{ V}$

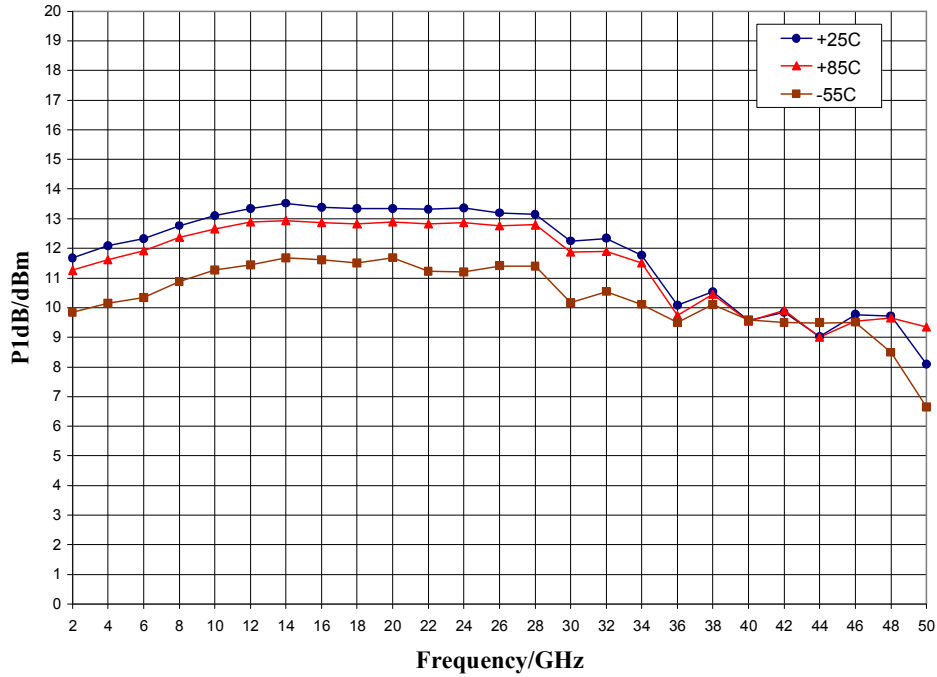

Output IP3 vs. Temperature, $V_{dd} = 4\text{ V}$, $V_{gg} = 3\text{ V}$

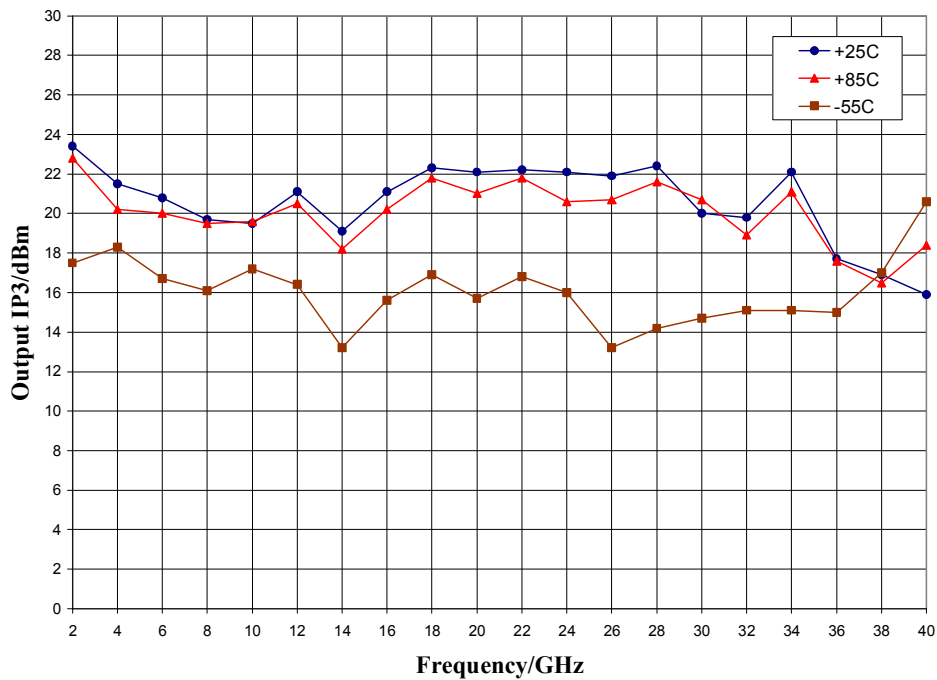

ver 1.2 0616

Mechanical Information

Die Outline (all dimensions in microns)

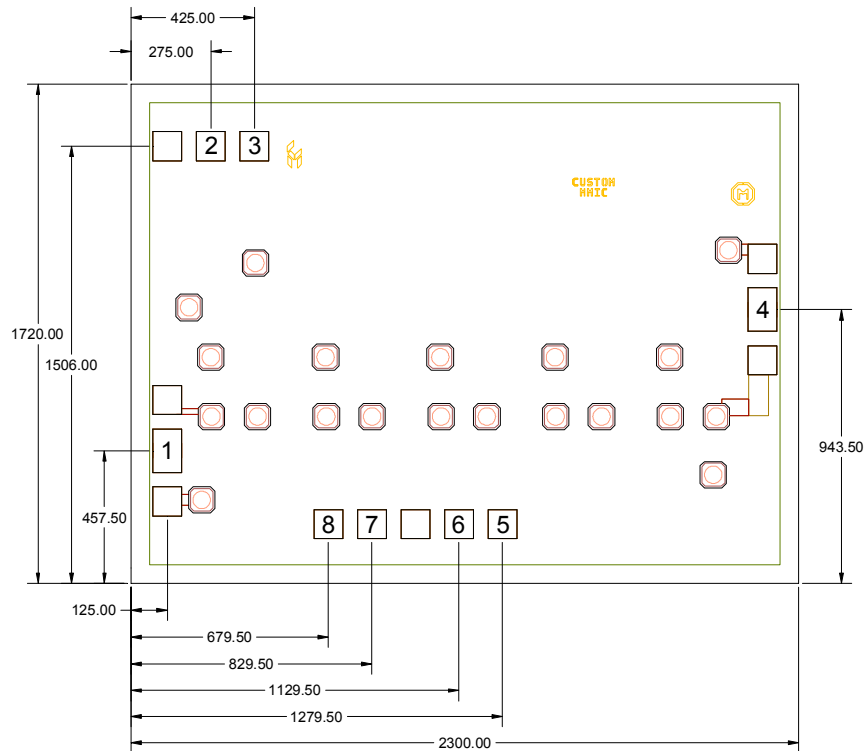

Notes:

1. No connection required for unlabeled pads
2. Backside is RF and DC ground
3. Backside and bond pad metal: Gold
4. Die is 85 microns thick
5. DC bond pads are 100 microns square

Pad Description

Pad Diagram

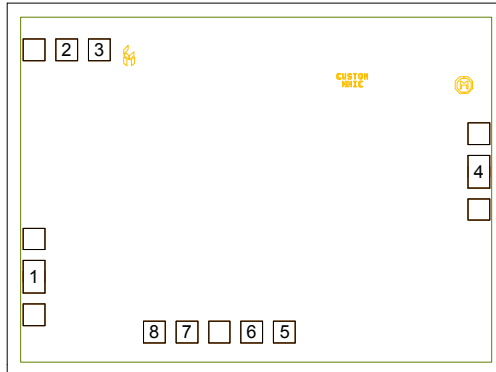

Functional Description

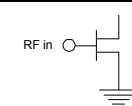
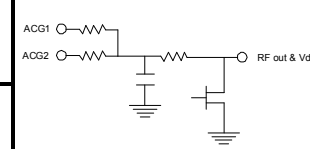
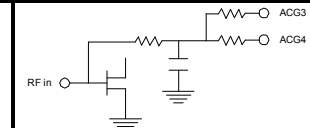
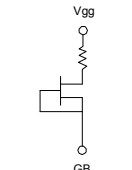
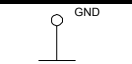
Pad	Function	Description	Schematic
1	RF in	50 ohm matched input	
2, 3	ACG1, 2	Low frequency termination. Attach bypass capacitor per application circuit	
4	RF out & Vdd	Power supply voltage and 50 ohm matched output	
5, 6	ACG3, 4	Low frequency termination. Attach bypass capacitor per application circuit	
7	Vgg	Power supply voltage Decoupling and bypass caps required	
8	GB	Connect to DC ground	
Backside	Ground	Connect to RF / DC ground	

Applications Information

Assembly Guidelines

The backside of the CMD206 is RF ground. Die attach should be accomplished with electrically and thermally conductive epoxy only. Eutectic attach is not recommended. Standard assembly procedures should be followed for high frequency devices. The top surface of the semiconductor should be made planar to the adjacent RF transmission lines, and the RF decoupling capacitors placed in close proximity to the DC connections on chip.

RF connections should be made as short as possible to reduce the inductive effect of the bond wire. Use of a 0.8 mil thermosonic wedge bonding is highly recommended as the loop height will be minimized. The RF input and output require a double bond wire as shown.

The semiconductor is 85 μm thick and should be handled by the sides of the die or with a custom collet. Do not make contact directly with the die surface as this will damage the monolithic circuitry. Handle with care.

Assembly Diagram

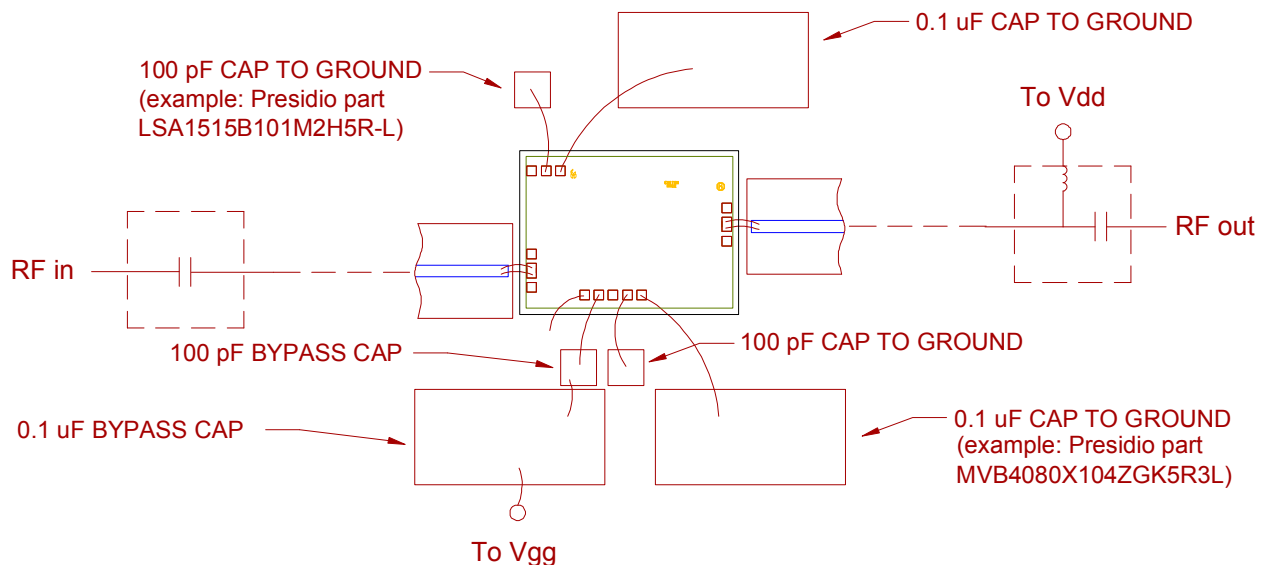

GaAs MMIC devices are susceptible to damage from Electrostatic Discharge. Proper precautions should be observed during handling, assembly and test.

ver 1.2 0616

Applications Information

Application Circuit

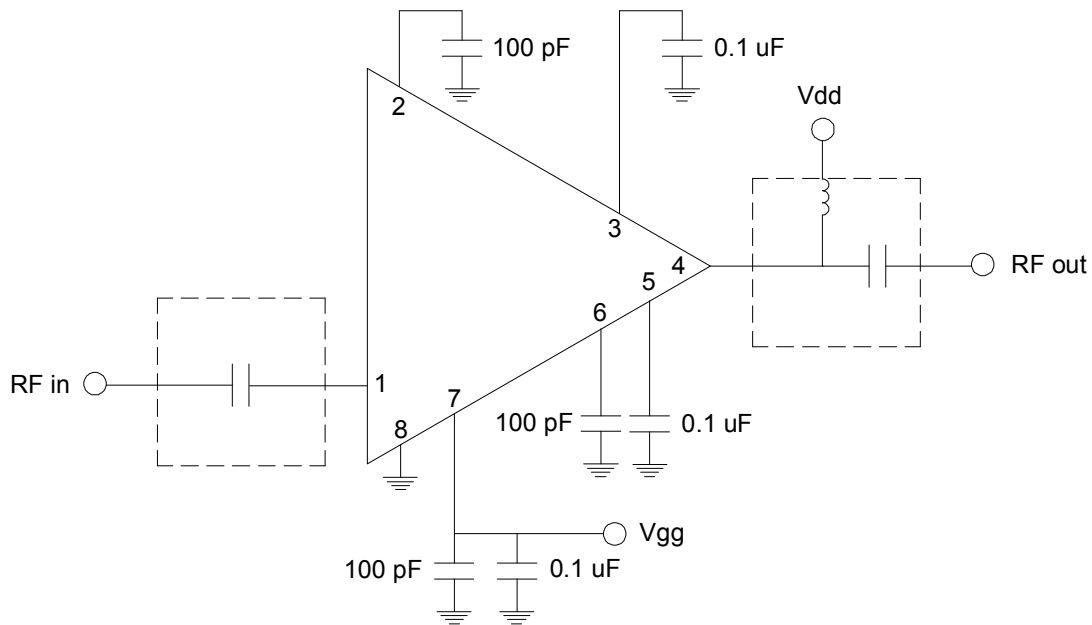

Note: Drain voltage (V_{dd}) must be applied through a broadband bias tee or external bias network. External DC block is required on RF input.

Biasing and Operation

The CMD206 is biased with a positive drain supply and a positive gate supply. Performance is optimized when the drain voltage is set to +4 V. The recommended gate voltage is +3 V.

Turn ON procedure:

1. Apply drain voltage V_{dd} and set to +4 V
2. Apply gate voltage V_{gg} and set to +3 V

Turn OFF procedure:

1. Turn off gate voltage V_{gg}
2. Turn off drain voltage V_{dd}

RF power can be applied at any time.