

### Features

- ▶ Wide bandwidth
- ▶ High linearity
- ▶ Single positive supply voltage
- ▶ On chip bias choke

### Description

The CMD197C4 is a wideband GaAs MMIC driver amplifier housed in a leadless surface mount package that is ideally suited for military, space and communications systems where small size and high linearity are needed. At 10 GHz the device delivers greater than 15 dB of gain with a corresponding output 1 dB compression point of +24 dBm and an output IP3 of 31 dBm. The CMD197C4 is a 50 ohm matched design which eliminates the need for RF port matching and includes an on chip bias choke.

### Functional Block Diagram

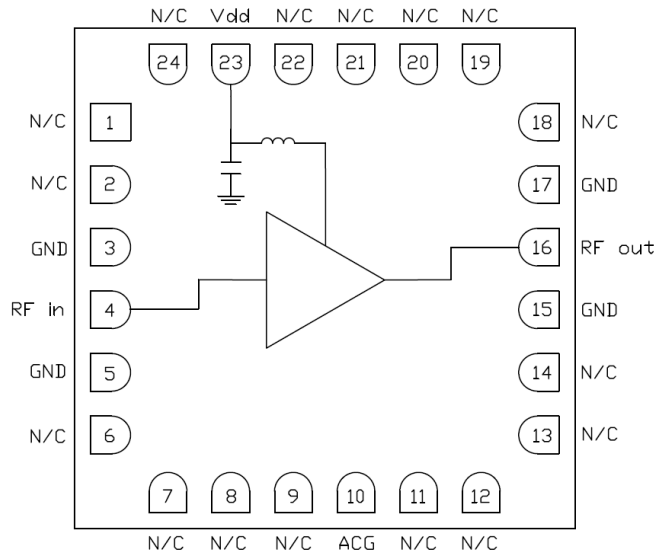

### Electrical Performance - $V_{dd} = 8.0 \text{ V}$ , $T_A = 25 \text{ }^\circ\text{C}$ , $F=10 \text{ GHz}$

Parameter	Min	Typ	Max	Units
Frequency Range	1 - 24			GHz
Gain		15.5		dB
Input Return Loss		20		dB
Output Return Loss		20		dB
Output P1dB		24		dBm
Output IP3		31		dBm
Supply Current		225		mA



# CMD197C4

## 1-24 GHz Distributed Driver Amplifier

### Specifications

#### Absolute Maximum Ratings

Parameter	Rating
Drain Voltage, V <sub>dd</sub>	10 V
RF Input Power	+20 dBm
Channel Temperature, T <sub>ch</sub>	150 °C
Power Dissipation, P <sub>diss</sub>	2.12 W
Thermal Resistance	30.6 °C/W
Operating Temperature	-40 to 85 °C
Storage Temperature	-55 to 150 °C

Exceeding any one or combination of the maximum ratings may cause permanent damage to the device.

#### Recommended Operating Conditions

Parameter	Min	Typ	Max	Units
V <sub>dd</sub>	5.0	8.0	9.0	V
I <sub>dd</sub>		225		mA

Electrical performance is measured at specific test conditions. Electrical specifications are not guaranteed over all recommended operating conditions.

#### Electrical Specifications, V<sub>dd</sub> = 8.0 V, T<sub>A</sub> = 25 °C

Parameter	Min	Typ	Max	Min	Typ	Max	Min	Typ	Max	Units
Frequency Range	1 - 6			6 - 18			18 - 22			GHz
Gain	12	15	18.5	12.5	15.5	19	12	16	19	dB
Noise Figure		3.5			2.5			4		dB
Input Return Loss		12			15			10		dB
Output Return Loss		15			15			13		dB
Output P <sub>1dB</sub>	20	24		20	24		17	21		dBm
Output IP <sub>3</sub>		33			32			29		dBm
Supply Current	155	225	280	155	225	280	155	225	280	mA
Gain Temperature Coefficient		.012			.012			.012		dB/°C
Noise Figure Temperature Coefficient		.009			.009			.009		dB/°C

ver. 3.0 0218

### Typical Performance

**Broadband Performance,  $V_{dd} = 8.0$  V,  $I_{dd} = 225$  mA,  $T_A = 25$  °C**

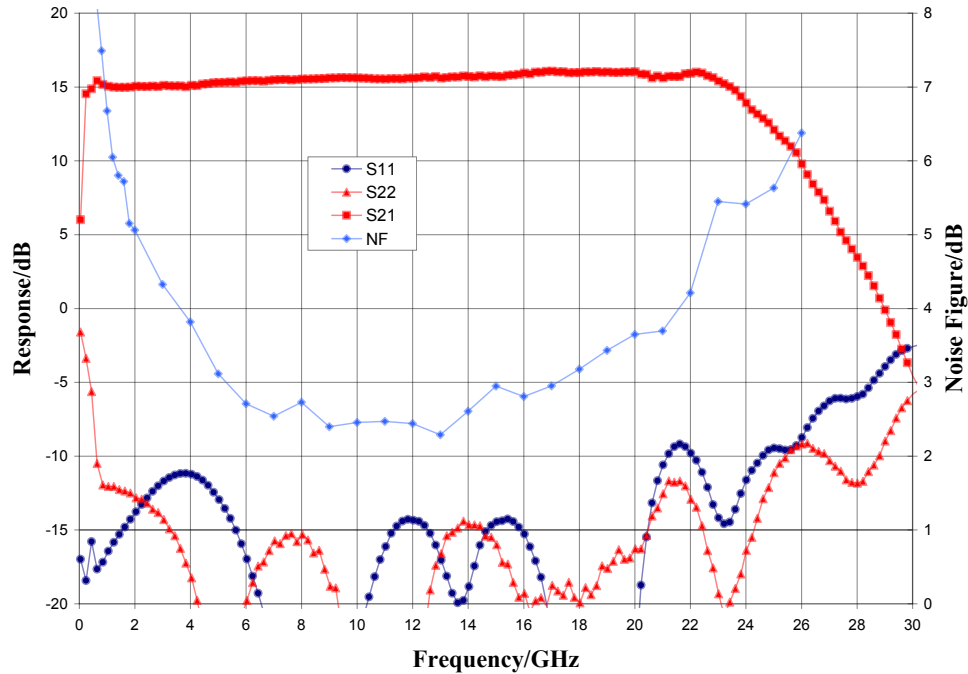

**Narrow-band Performance,  $V_{dd} = 8.0$  V,  $I_{dd} = 225$  mA,  $T_A = 25$  °C**

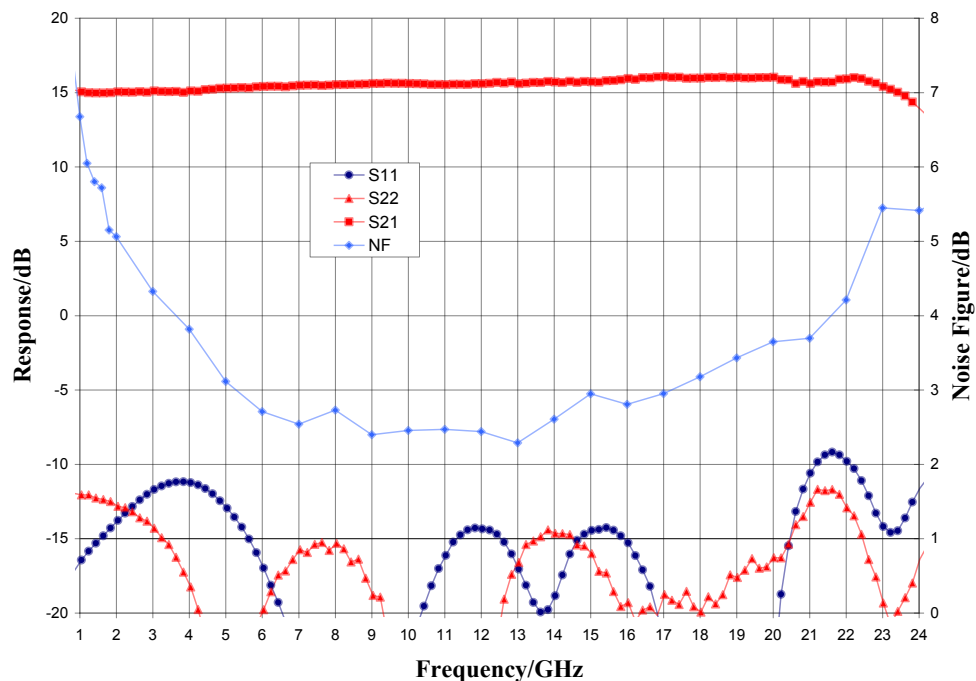

ver. 3.0 0218

### Typical Performance

**Gain vs. Temperature,  $V_{dd} = 8.0$  V**

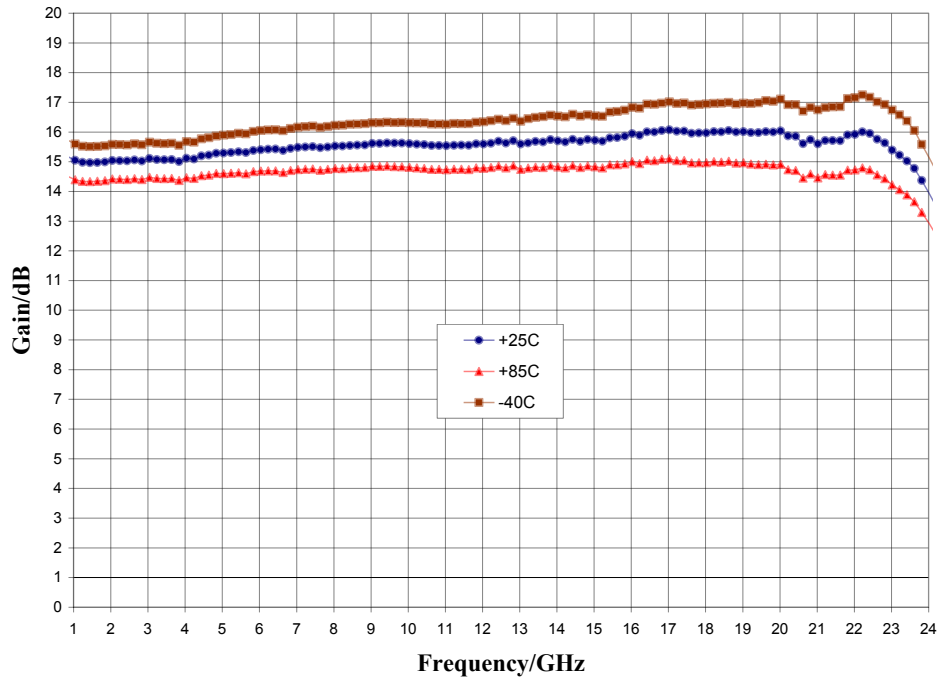

**Noise Figure vs. Temperature,  $V_{dd} = 8.0$  V**

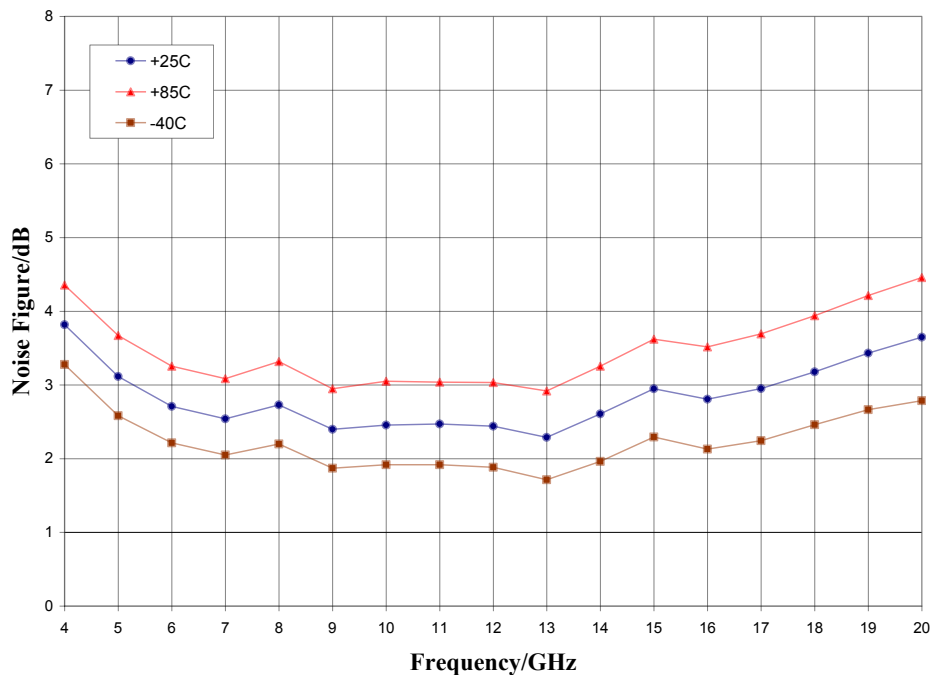

ver. 3.0 0218

### Typical Performance

#### Output Power, $V_{dd} = 8.0\text{ V}$

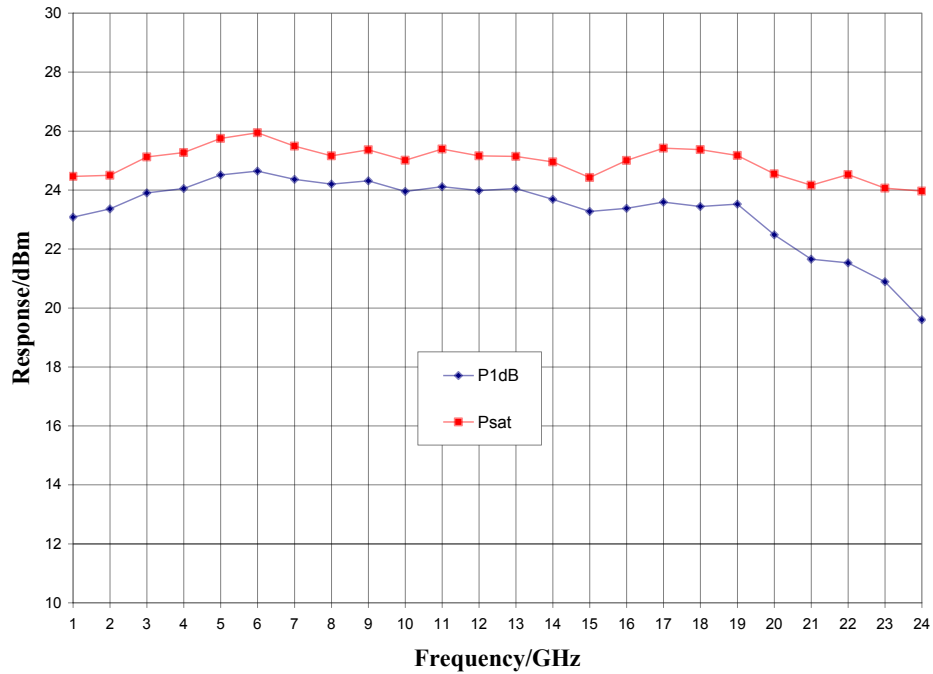

#### P1dB vs. Temperature, $V_{dd} = 8.0\text{V}$

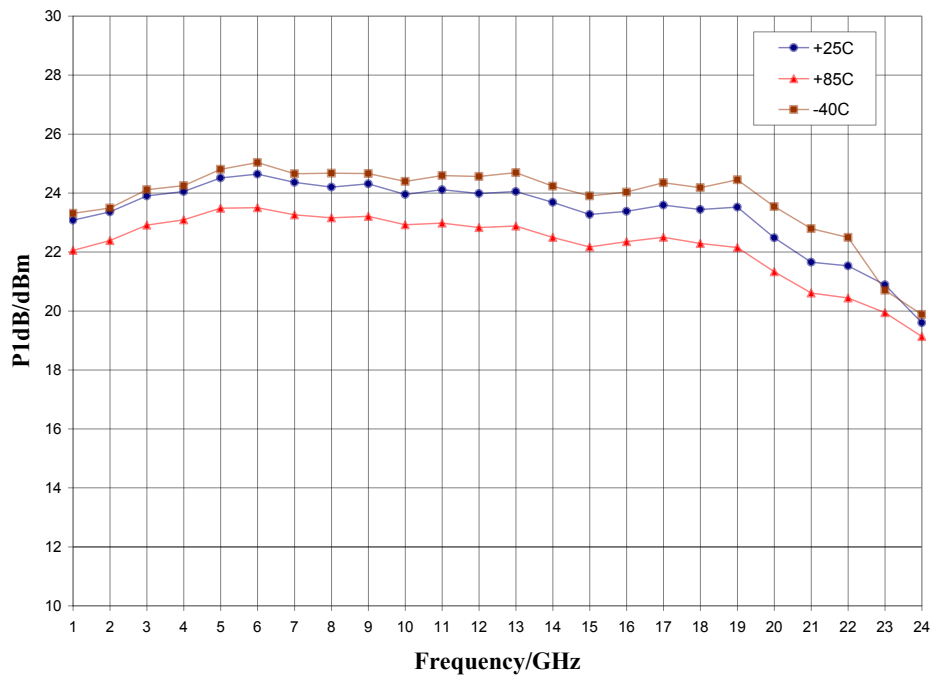

ver. 3.0 0218

### Typical Performance

Output IP3,  $V_{dd} = 8.0$  V

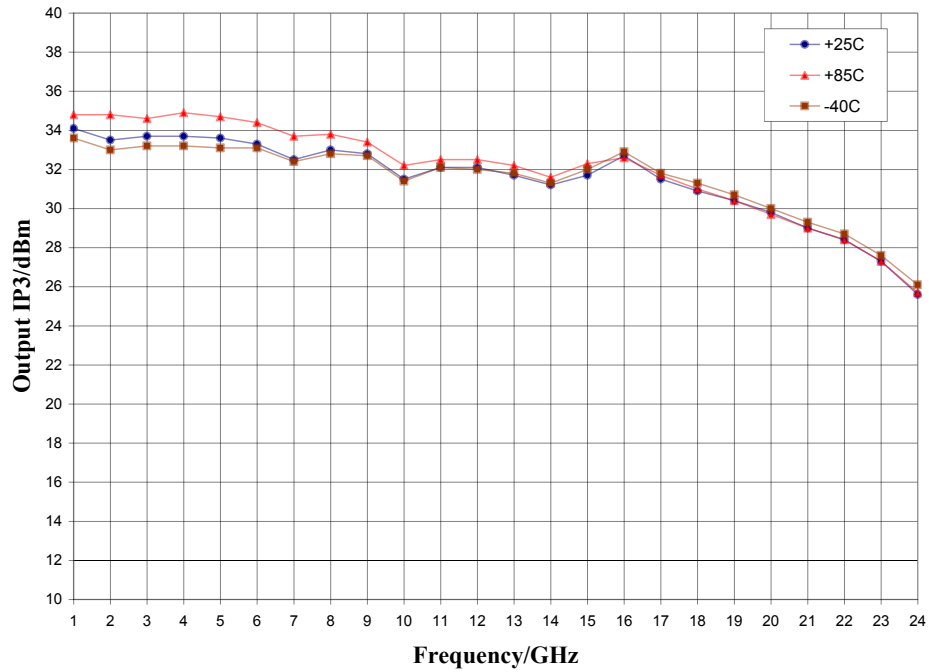

### Mechanical Information

#### Package Information and Dimensions

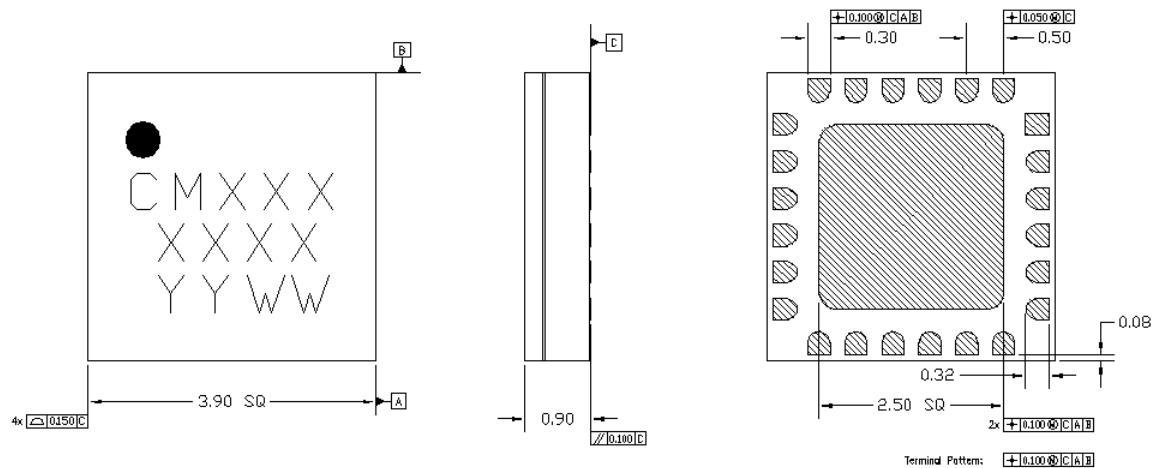

#### NOTES:

- ALL DIMENSIONS SHOWN IN mm.
- MATERIAL: BLACK ALUMINA
- LEAD FINISH:
  - Ni: 8.89um MAX, 1.27um MIN
  - Pd: 0.17um MAX, 0.07um MIN
  - Au: 0.254um MAX, 0.03um MIN
- MARKING
  - LINE 1: PART NUMBER
    - EXAMPLE: CMD197C4 SHALL BE MARKED AS CM197
  - LINE 2: LDT NUMBER
  - LINE 3: DATE CODE - LAST 2 DIGITS OF THE YEAR OF MANUFACTURE FOLLOWED BY A 2 DIGIT WEEK CODE
- ALTERNATE PIN #1 IDENTIFIER IS A SINGLE SQUARE PAD

#### Recommended PCB Land Pattern

Custom MMIC Design Services recommends that the user develop the land pattern that will provide the best design for proper solder reflow and device attach for their specific application. Please review CMDS Application Note AN 105 for a recommended land pattern approach.

#### Recommended Solder Reflow Profile

Custom MMIC Design Services recommends screen printing with belt furnace reflow to ensure proper solder reflow and device attach. Please review CMDS Application Note AN 102 for a recommended solder reflow profile.

### Pin Description

#### Pin Diagram

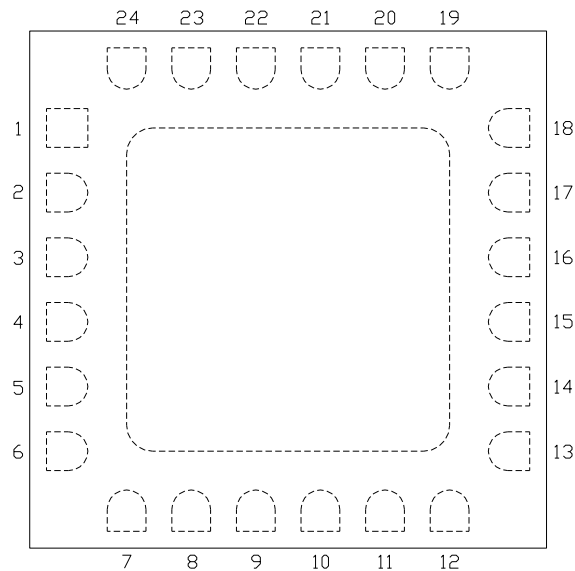

#### Functional Description

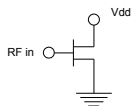
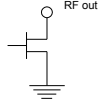
Pad	Function	Description	Schematic
1, 2, 6-9, 11-14, 18-22, 24	N/C	No connection required. These pins may be connected to RF/DC ground.	
3, 5, 15, 17 and die paddle	Ground	Connect to RF / DC ground	
4	RF in	50 ohm matched input External DC block required	
23	Vdd	Power supply voltage Decoupling and bypass caps required	
16	RF out	50 ohm matched output External DC block required	
10	ACG	Low frequency termination. Attach bypass capacitor per application circuit	



### Applications Information

#### Application Circuit

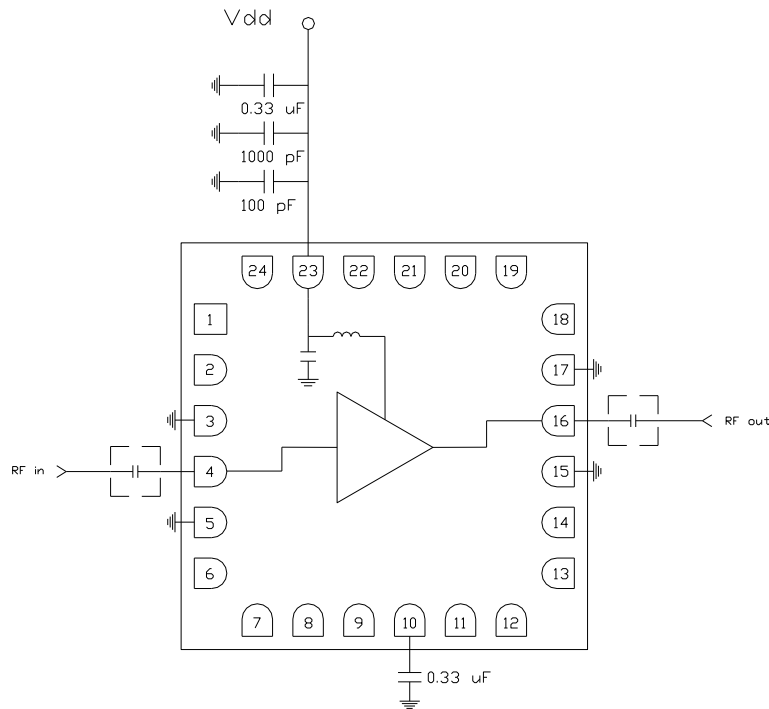

#### Biasing and Operation

The CMD197C4 is biased with a single positive drain supply. Performance is optimized when the drain voltage is set to +8.0 V.

Turn ON procedure:

1. Apply drain voltage  $V_{dd}$  and set to +8 V

Turn OFF procedure:

1. Turn off drain voltage  $V_{dd}$

RF power can be applied at any time.

**GaAs MMIC devices are susceptible to damage from Electrostatic Discharge. Proper precautions should be observed during handling, assembly and test.**

ver. 3.0 0218

### Applications Information

#### Evaluation Board

The circuit board shown has been developed for optimized assembly at Custom MMIC. A sufficient number of via holes should be used to connect the top and bottom ground planes. As surface mount processes vary, careful process development is recommended.

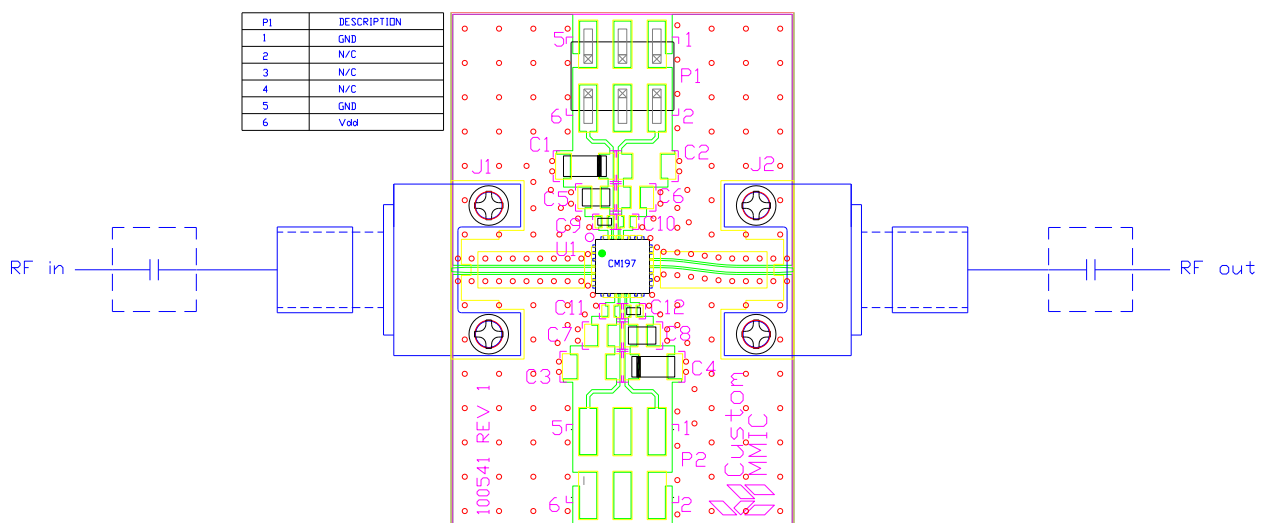

#### Bill of Material

Designator	Value	Description
J1, J2		SMA End Launch Connector
P1		6 Pin Header
C1, C4	0.33 $\mu$ F	Capacitor, Tantalum
C5, C8	1000 pF	Capacitor, 0603
C9, C12	100 pF	Capacitor, 0402
U1		CMD197C4 Driver Amplifier
PCB		100541 Evaluation PCB

*Please note, All information contained in this data sheet is subject to change without notice.* ver. 3.0 0218