

### Features

- ▶ Low conversion loss
- ▶ High isolation
- ▶ Image rejection: 30 dB
- ▶ Wide IF bandwidth
- ▶ Pb-free RoHs compliant 4x4 mm SMT package

### Description

The CMD182C4 is a compact I/Q mixer in a leadless surface mount package that can be used as either an image reject mixer or a single sideband upconverter. The CMD182C4 utilizes two double balanced mixer cells and a 90 degree hybrid. An external IF hybrid is needed to complete the image rejection. The CMD182C4 is a much smaller alternative to higher cost hybrid image reject mixers and single sideband upconverter assemblies.

### Functional Block Diagram

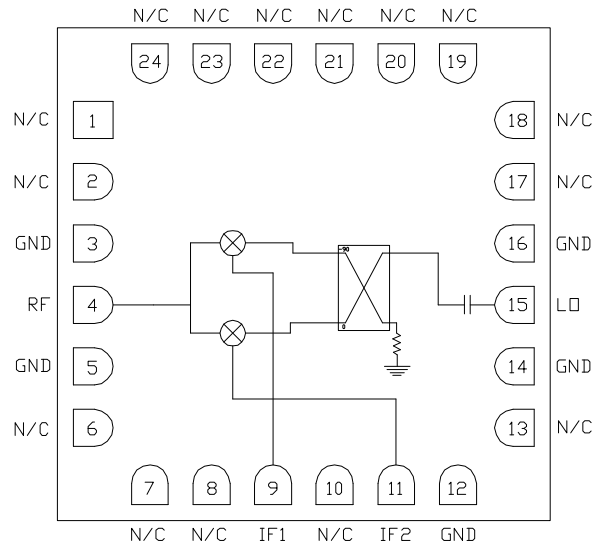

### Electrical Performance - IF = 100 MHz, LO = +15 dBm, T<sub>A</sub> = 25 °C, F = 8 GHz

Parameter	Min	Typ	Max	Units
Frequency Range, RF & LO	6 - 10			GHz
Frequency Range, IF	DC		3.5	GHz
Conversion Loss (as IRM)		6		dB
Image Rejection		30		dB
LO to RF Isolation		46		dB
LO to IF Isolation		20		dB
Input P1dB		9		dBm

Unless otherwise noted, all measurements performed as a downconverter, IF = 100 MHz

### Specifications

#### Absolute Maximum Ratings

Parameter	Rating
RF / IF Input Power	+25 dBm
LO Drive	+25 dBm
Operating Temperature	-40 to 85 °C
Storage Temperature	-55 to 150 °C

Operation of this device outside the maximum ratings may cause permanent damage.

#### Electrical Specifications - IF = 100 MHz, LO = +15 dBm, T<sub>A</sub> = 25 °C

Parameter	Min	Typ	Max	Min	Typ	Max	Units
Frequency Range, RF & LO	6 - 10			7.1 - 8.5			GHz
Frequency Range, IF	DC		3.5	DC		3.5	GHz
Conversion Loss (as IRM)		6	9		5.5	8	dB
Image Rejection	20	28		25	30		dB
LO to RF Isolation	39	50		39	50		dB
LO to IF Isolation	15	20		15	20		dB
Input P1dB		9			9		dBm
Input IP3		18			17.5		dBm

Unless otherwise noted, all measurements performed as a downconverter, IF = 100 MHz

### Typical Performance

Data Taken As IRM With External IF Hybrid

Conversion Gain vs. Temperature, LO = +15 dBm, IF = 100 MHz USB

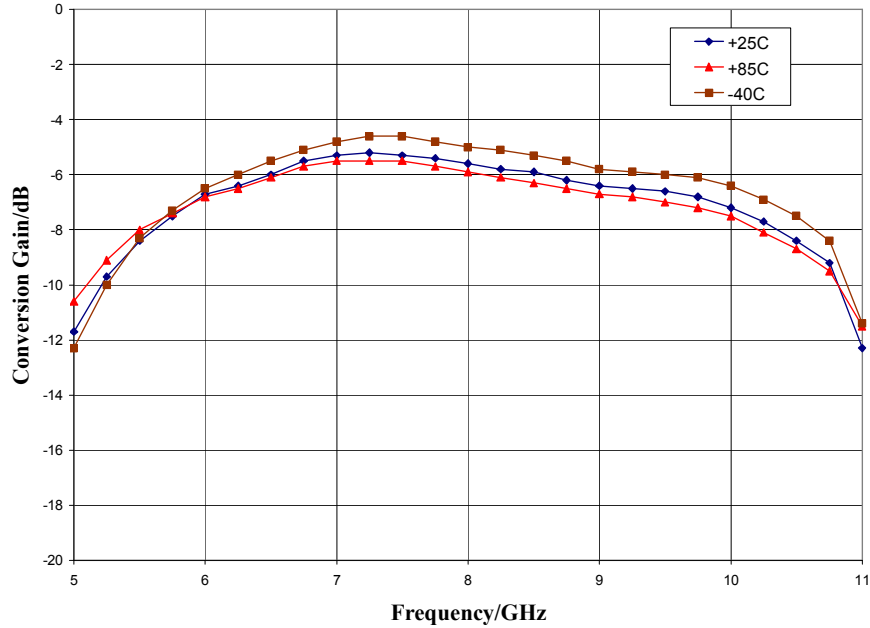

Conversion Gain vs. LO Drive, IF = 100 MHz USB

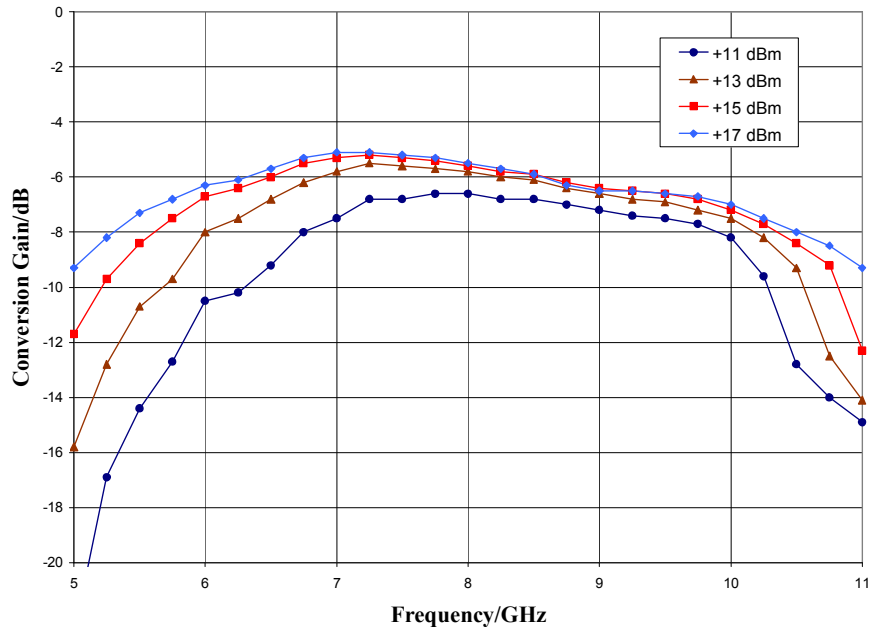

ver 1.7 1017

### Typical Performance

Data Taken As IRM With External IF Hybrid

Image Rejection, LO = +15 dBm, IF = 100 MHz USB

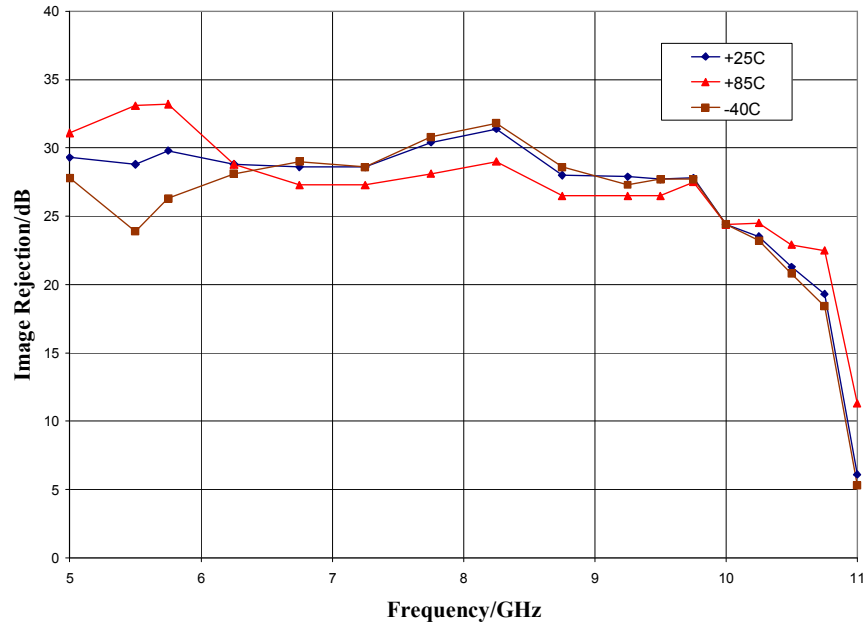

Return Loss, LO = +15 dBm

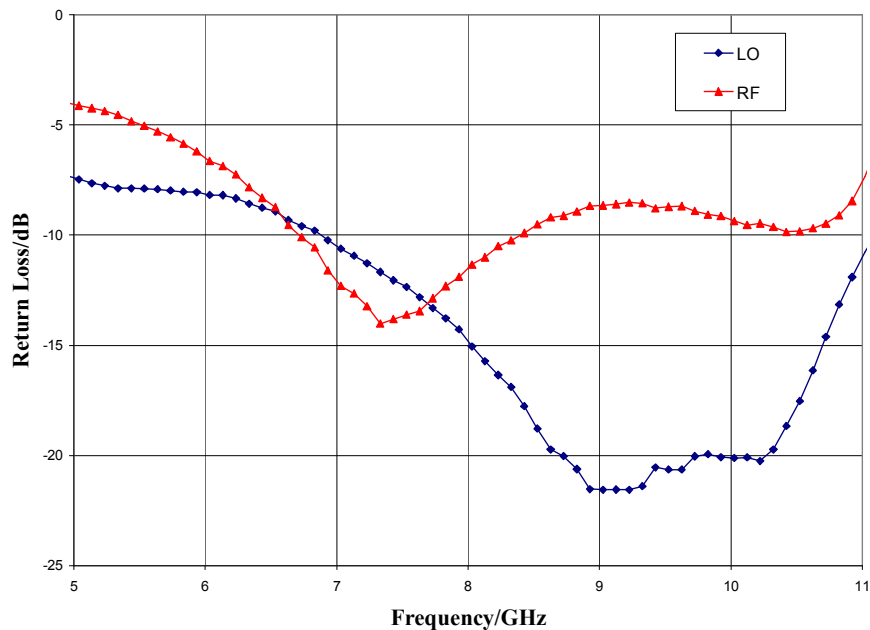

ver 1.7 1017

### Typical Performance

Data Taken As IRM With External IF Hybrid

Input P1dB vs. Temperature, LO = +15 dBm, IF = 100 MHz USB

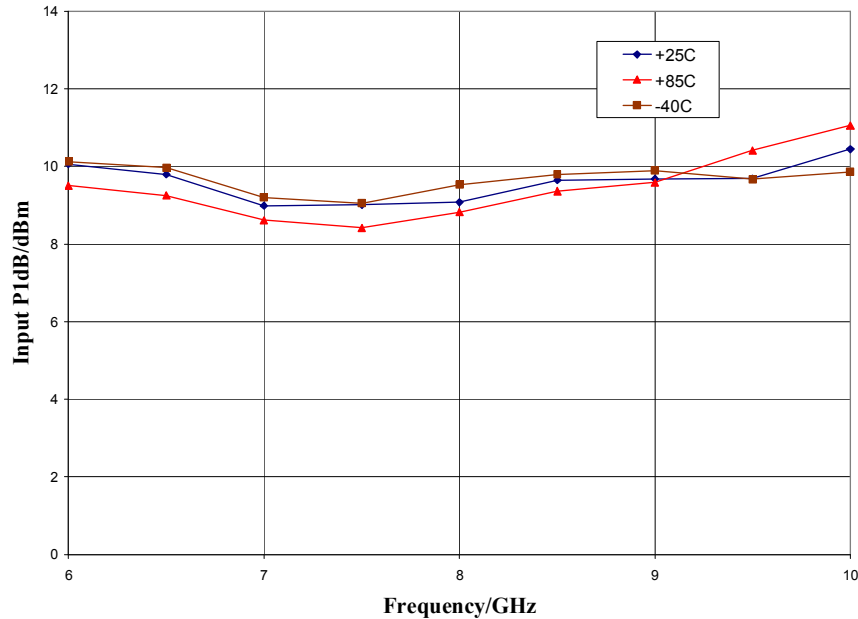

Input IP3 vs. Temperature, LO = +15 dBm, IF = 100 MHz USB

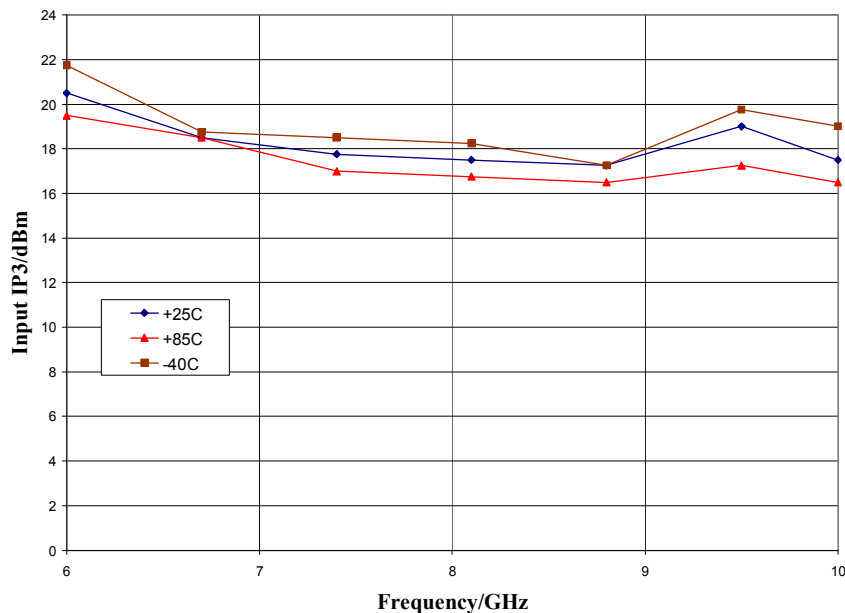

ver 1.7 1017

### Typical Performance

Data Taken As IRM With External IF Hybrid

Input IP3 vs. LO Drive, IF = 100 MHz USB

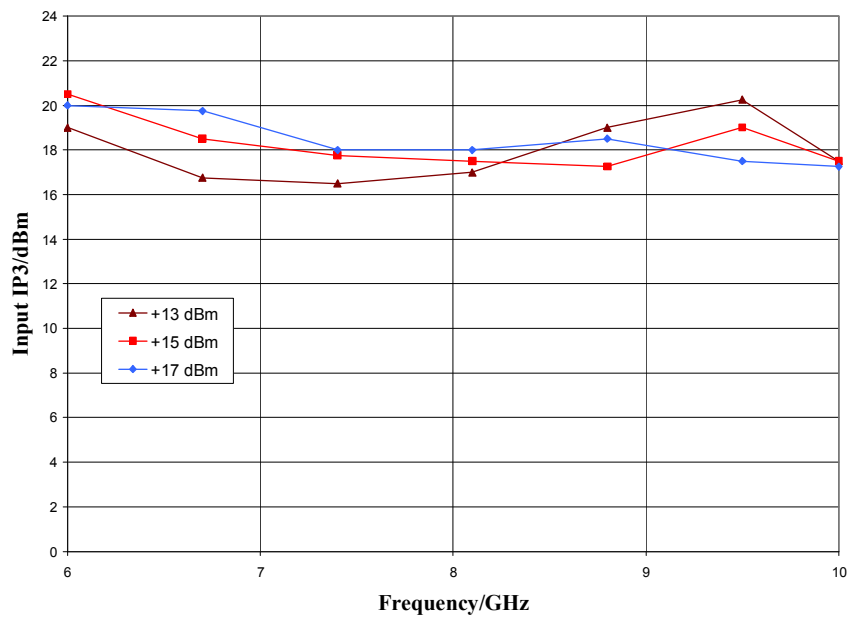

Upconverter Performance, Conversion Gain vs. LO Drive, IF = 1 GHz

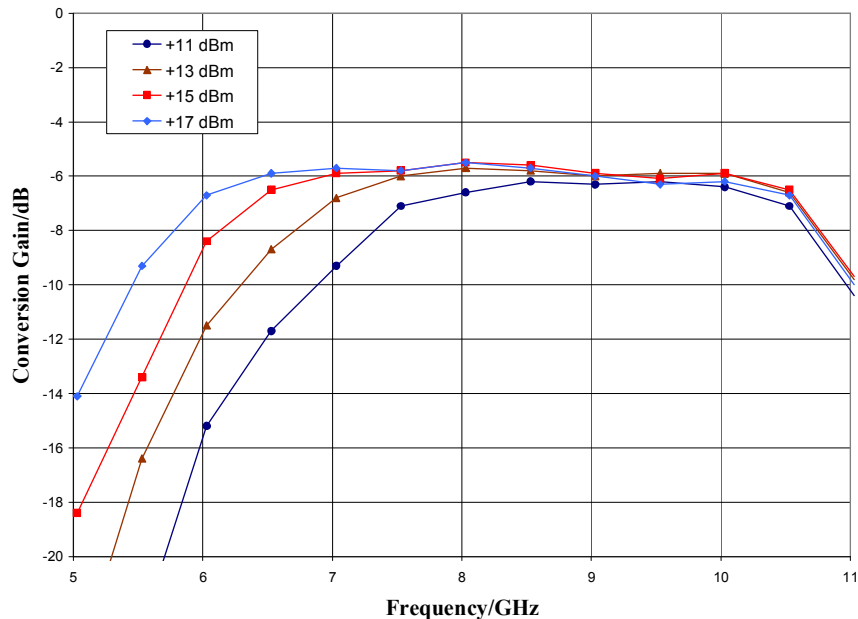

ver 1.7 1017

### Typical Performance

Data Taken As IRM With External IF Hybrid

Upconverter Performance, Input IP3 vs. LO Drive, IF = 500 MHz

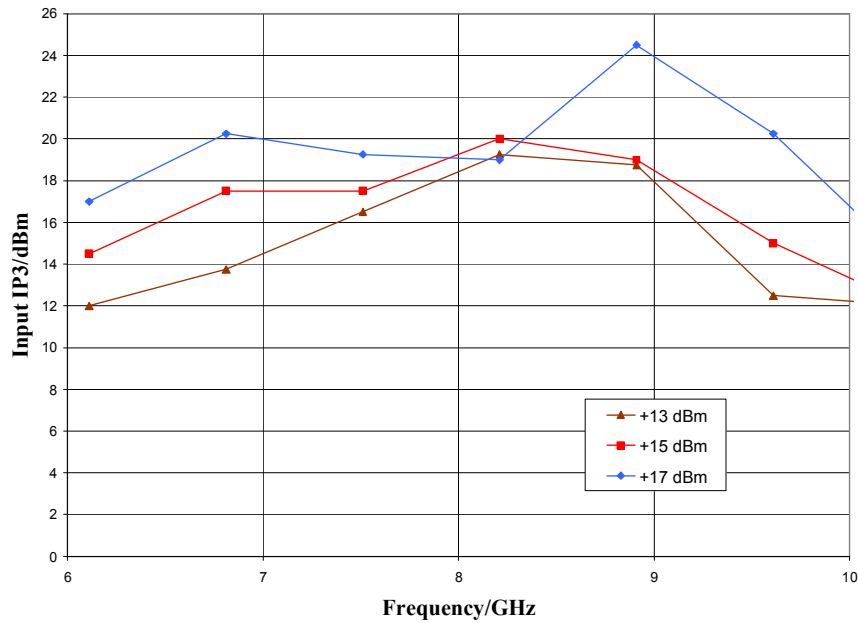

IF Bandwidth, LO = +15 dBm, Return Loss Data Taken Without IF Hybrid

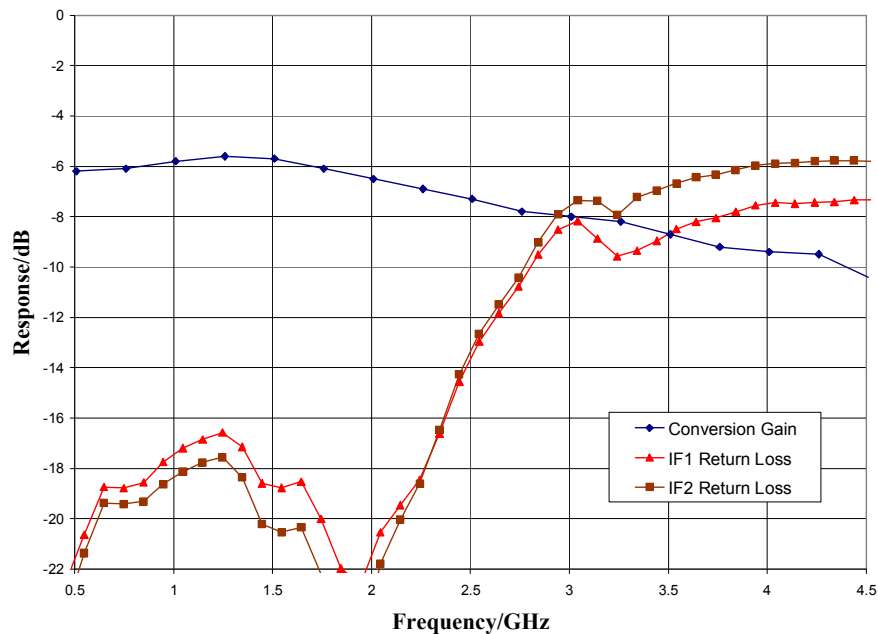

ver 1.7 1017

### Typical Performance

Isolation, LO = +15 dBm. Data Taken Without IF Hybrid

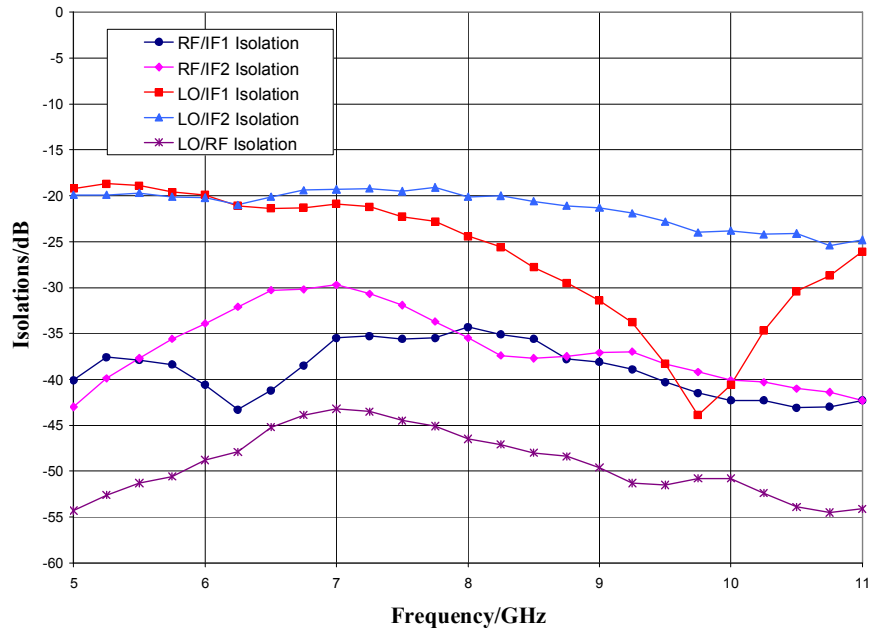



### Mechanical Information

### Package Information and Dimensions

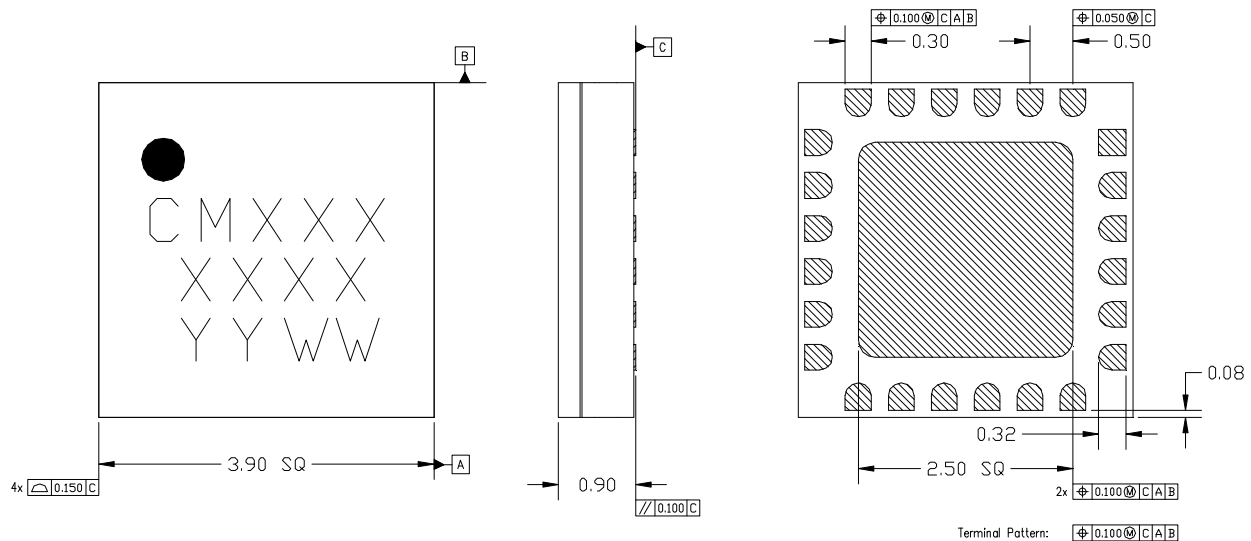

- NOTES:
1. ALL DIMENSIONS SHOWN IN mm.
  2. MATERIAL: BLACK ALUMINA
  3. LEAD FINISH:
    - 3.1. Ni: 8.89um MAX, 1.27um MIN
    - 3.2. Pd: 0.17um MAX, 0.07um MIN
    - 3.3. Au: 0.254um MAX, 0.03um MIN
  4. MARKING
    - 4.1. LINE 1: PART NUMBER
      - 4.1.1. EXAMPLE: CMD191C4 SHALL BE MARKED AS CM191
    - 4.2. LINE 2: LOT NUMBER
    - 4.3. LINE 3: DATE CODE - LAST 2 DIGITS OF THE YEAR OF MANUFACTURE FOLLOWED BY A 2 DIGIT WEEK CODE
  5. ALTERNATE PIN #1 IDENTIFIER IS A SINGLE SQUARE PAD
  6. ALTERNATE DIE PADDLE MAY HAVE CHAMFERED CORNERS

### Recommended PCB Land Pattern

Custom MMIC Design Services recommends that the user develop the land pattern that will provide the best design for proper solder reflow and device attach for their specific application. Please review Custom MMIC Application Note AN 105 for a recommended land pattern approach.

### Recommended Solder Reflow Profile



Custom MMIC Design Services recommends screen printing with belt furnace reflow to ensure proper solder reflow and device attach. Please review Custom MMIC Application Note AN 102 for a recommended solder reflow profile.

### Pin Description

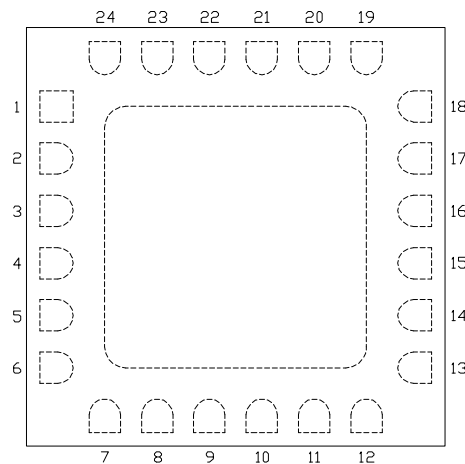
#### Pin Diagram

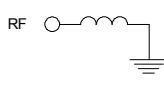
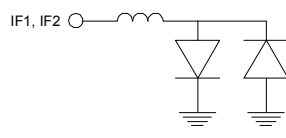

#### Functional Description

Pin	Function	Description	Schematic
1, 2, 6-8, 10, 13, 17-24	N/C	No connection required. These pins may be connected to RF/DC ground.	
3, 5, 12, 14, 16 and die paddle	Ground	Connect to RF / DC ground.	
4	RF	This pin is DC coupled and matched to 50 ohms.	
9	IF1	This pin is DC coupled. For applications not requiring operation to DC, this port should be DC blocked externally using a series capacitor whose value has been chosen to pass the necessary IF frequency range. For operation to DC, this pin must not source or sink more than 16 mA of current or part non-function or part failure may result.	
11	IF2		
15	LO	This pin is AC coupled and matched to 50 ohms.	

ver 1.7 1017

### Applications Information

#### Evaluation Board

The circuit board shown has been developed for optimized assembly at Custom MMIC. A sufficient number of via holes should be used to connect the top and bottom ground planes. As surface mount processes vary, careful process development is recommended.

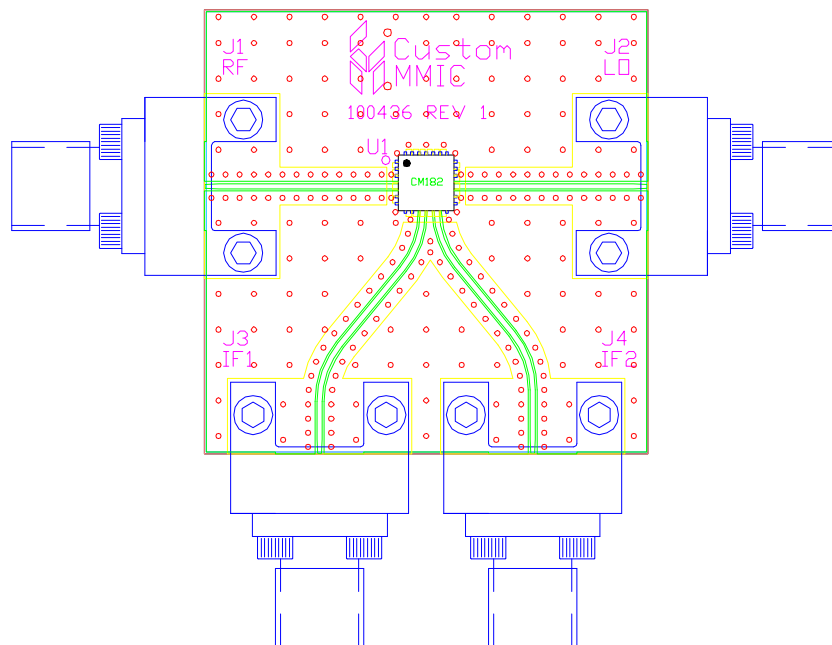

#### Bill of Material

Designator	Value	Description
J1 - J4		SMA End Launch Connector
U1		CMD182C4 I/Q Mixer
PCB		100436 Evaluation PCB

**GaAs MMIC devices are susceptible to damage from Electrostatic Discharge. Proper precautions should be observed during handling, assembly and test.**

ver 1.7 1017