

Features

- ▶ Low conversion loss
- ▶ High isolation
- ▶ Wide IF bandwidth
- ▶ Passive double balanced topology
- ▶ Pb-free RoHs compliant 3x3 mm SMT package

Description

The CMD178C3 is a general purpose double balanced mixer in a leadless surface mount package that can be used for up- and downconverting applications between 11 and 20 GHz. The CMD178C3 has very high isolation to both the RF and IF ports due to the optimized balun structures, and can operate with an LO drive level as low as +9 dBm. The CMD178C3 can easily be configured as an image reject mixer or single sideband modulator with external hybrids and power splitters.

Functional Block Diagram

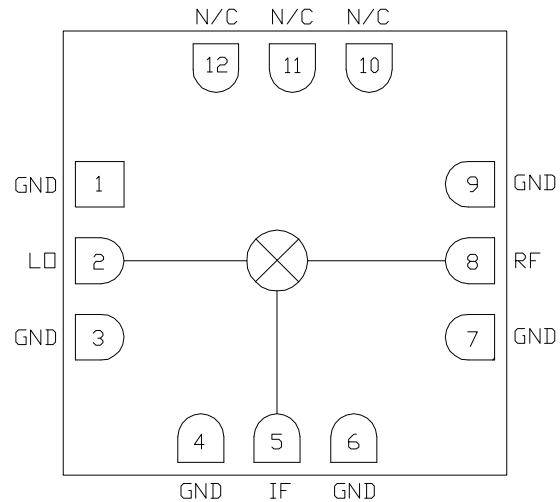

Electrical Performance - IF = 100 MHz, LO = +13 dBm, $T_A = 25^\circ\text{C}$, F = 15 GHz

Parameter	Min	Typ	Max	Units
Frequency Range, RF & LO	11 - 21			GHz
Frequency Range, IF	DC		6	GHz
Conversion Loss		6		dB
LO to RF Isolation		45		dB
LO to IF Isolation		45		dB
RF to IF Isolation		26		dB
Input P1dB		9		dBm

Unless otherwise noted, all measurements performed as a downconverter, IF = 100 MHz



CMD178C3

11-21 GHz Fundamental Mixer

Specifications

Absolute Maximum Ratings

Parameter	Rating
RF / IF Input Power	+25 dBm
LO Drive	+25 dBm
Operating Temperature	-40 to 85 °C
Storage Temperature	-55 to 150 °C

Operation of this device outside the maximum ratings may cause permanent damage.

Electrical Specifications - IF = 100 MHz, LO = +13 dBm, T_A = 25 °C

Parameter	Min	Typ	Max	Min	Typ	Max	Units
Frequency Range, RF & LO	13 - 17			11 - 21			GHz
Frequency Range, IF	DC		6	DC		6	GHz
Conversion Loss		6	8		7	10	dB
Noise Figure (SSB)		6	8		7	10	dB
LO to RF Isolation	35	43		31	43		dB
LO to IF Isolation	33	48		30	38		dB
RF to IF Isolation	17	25		15	25		dB
Input P1dB		9			9		dBm
Input IP3		16			16		dBm

Unless otherwise noted, all measurements performed as a downconverter, IF = 100 MHz

ver 1.4 0616

Typical Performance

Conversion Gain vs. Temperature, LO = +13 dBm, IF = 100 MHz USB

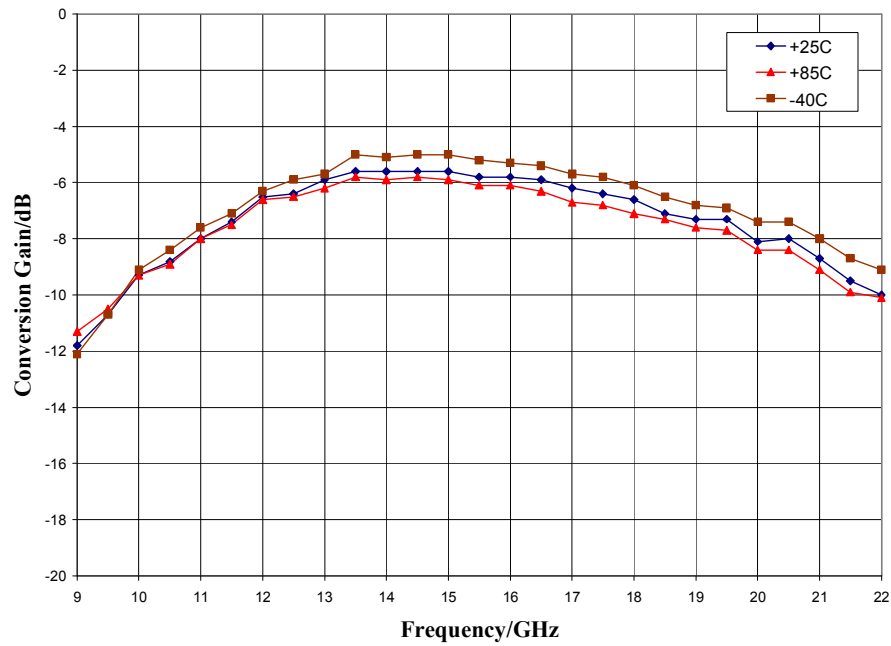

Isolation, LO = +13 dBm

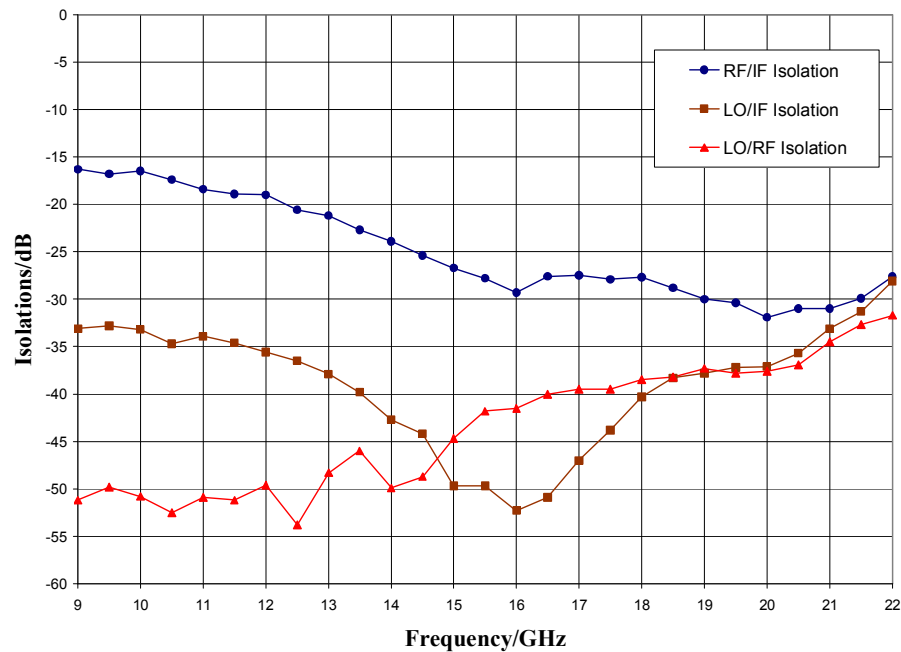

ver 1.4 0616

Typical Performance

Conversion Gain vs. LO Drive, IF = 100 MHz USB

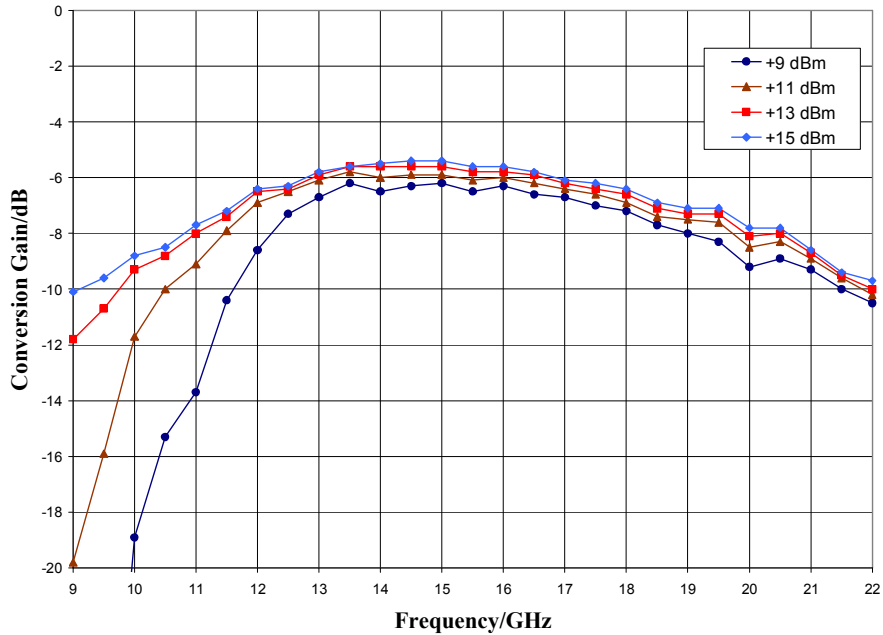

Return Loss, LO = + 13 dBm

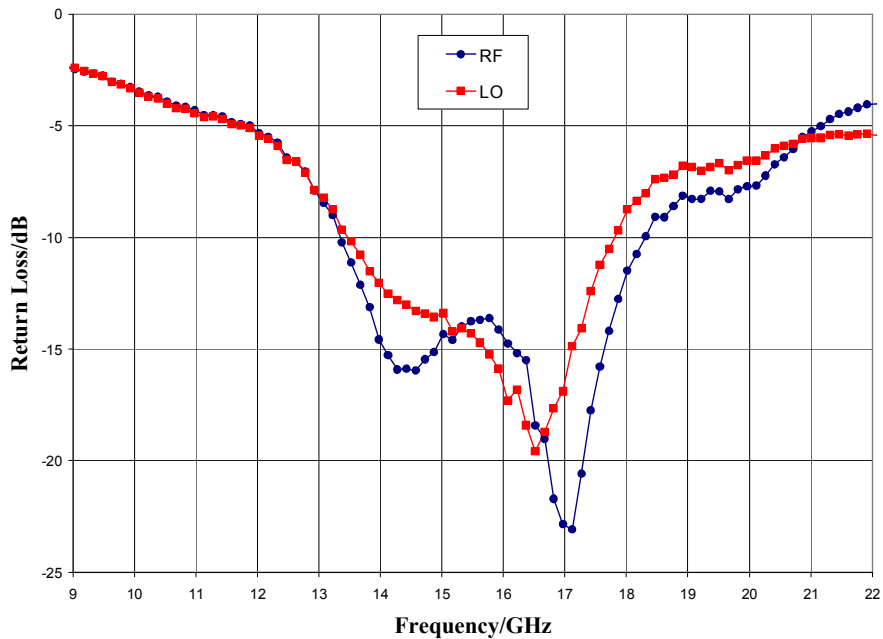

ver 1.4 0616

Typical Performance

IF Bandwidth, LO = +13 dBm

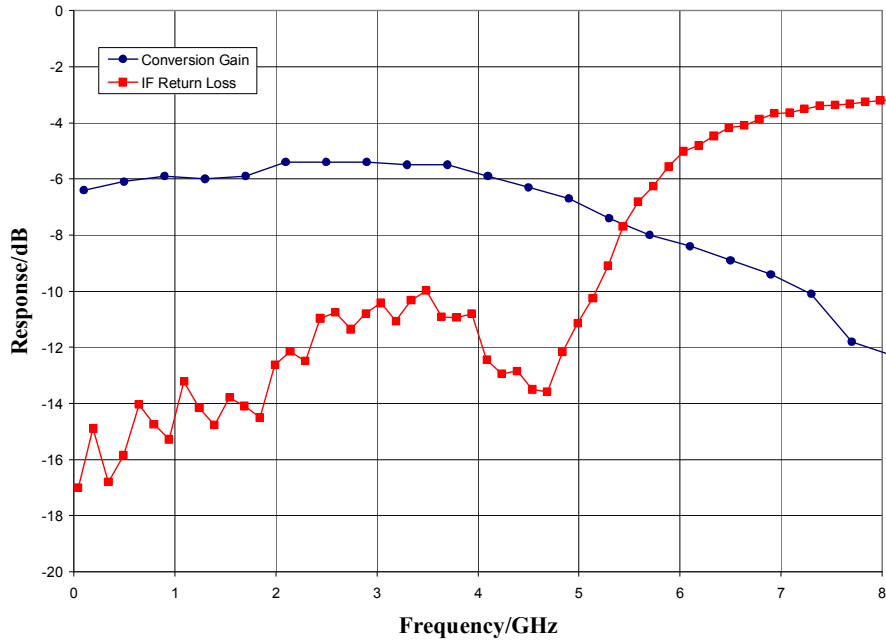

Upconverter Performance, Conversion Gain vs. LO Drive, IF input = 100 MHz

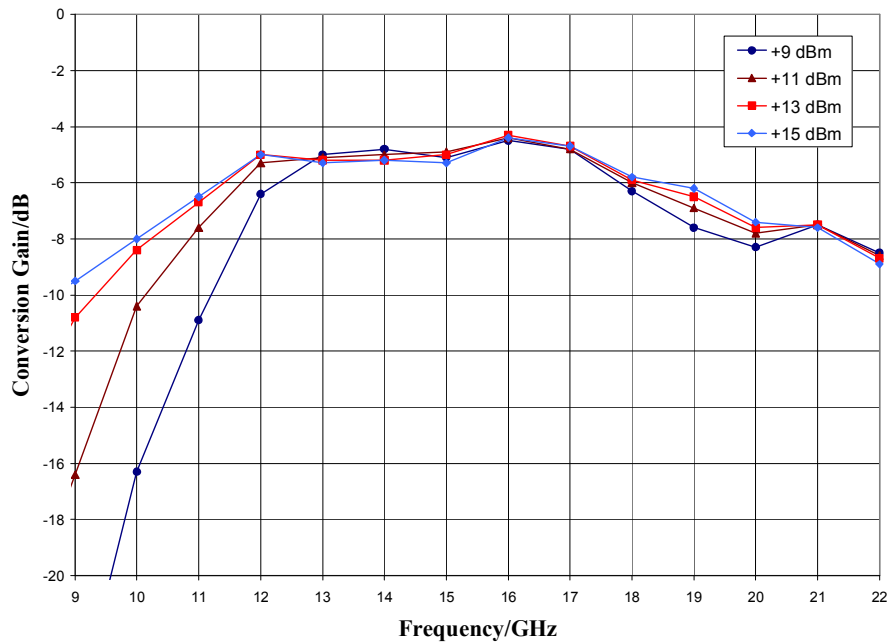

ver 1.4 0616

Typical Performance

Input IP3 vs. Temperature, LO = +13 dBm, IF = 100 MHz

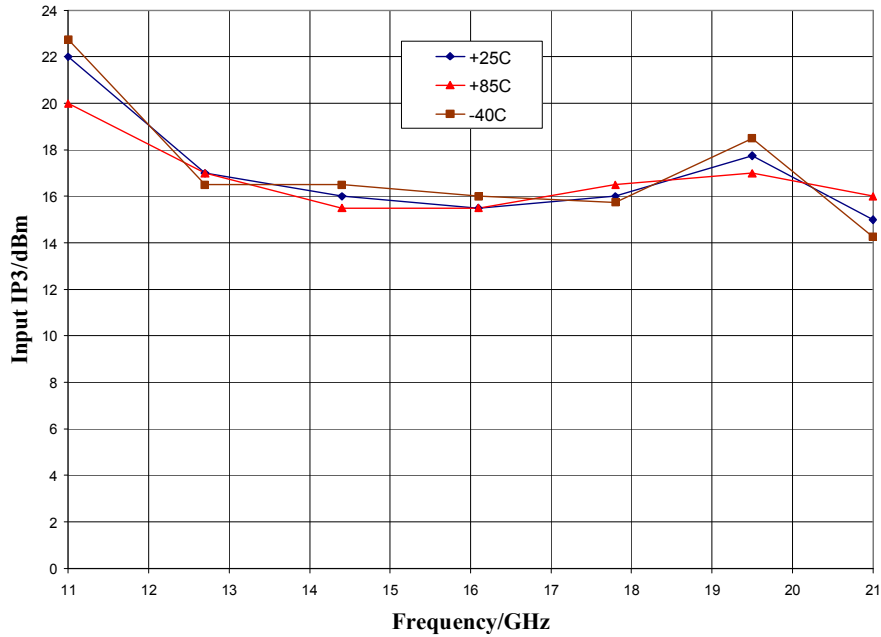

Input IP3 vs. LO Drive, IF = 100 MHz

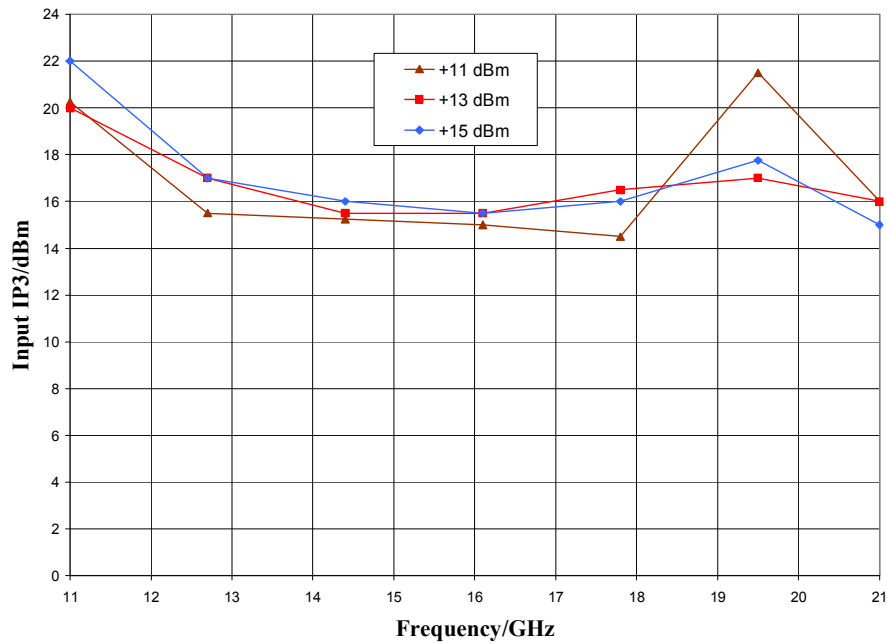

ver 1.4 0616

Typical Performance

Upconverter Performance, Input IP3 vs. LO Drive, IF = 500 MHz

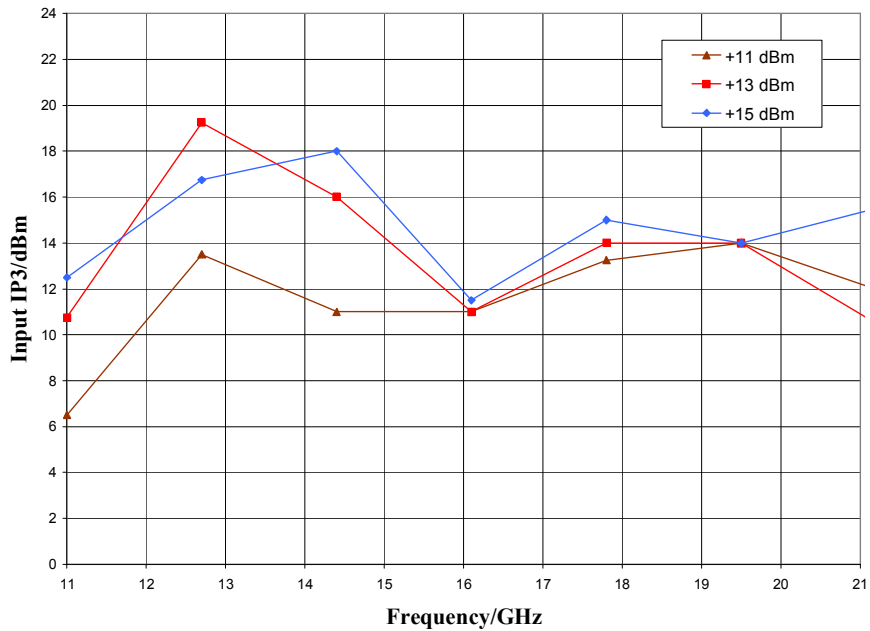

Input P1dB vs. Temperature, LO = +13 dBm, IF = 100 MHz USB

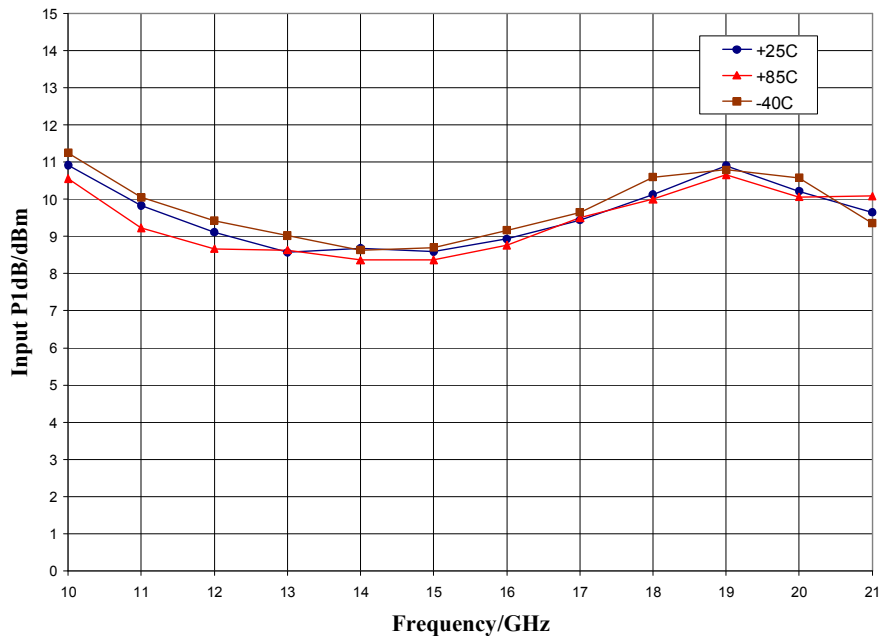

ver 1.4 0616

Typical Performance

MxN Spurious Outputs

mRF	nLO				
	0	1	2	3	4
0	xx	25	33	> 90	> 90
1	28	0	47	40	> 90
2	72	64	64	67	75
3	> 90	> 90	> 90	64	> 90
4	> 90	> 90	> 90	> 90	> 90

RF = 15.1 GHz @ -10 dBm
 LO = 15.0 GHz @ +13 dBm
 All values in dBc below the IF output power level (1RF - 1LO)

Mechanical Information

Package Information and Dimensions

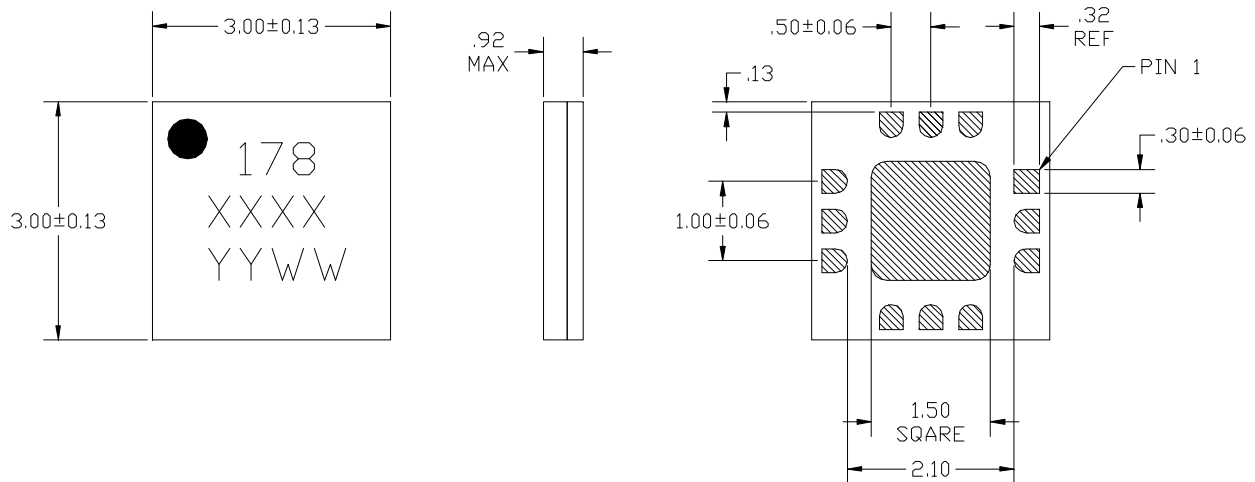

NOTES:

1. DIMENSIONS ARE IN MILLIMETERS
2. MATERIAL: BLACK ALUMINA
3. LEAD FINISH: 30-80 MICRONS GOLD OVER 50 MICRONS NICKEL.
4. ALTERNATE PIN #1 IDENTIFIER IS SINGLE SQUARE PAD.

Recommended PCB Land Pattern

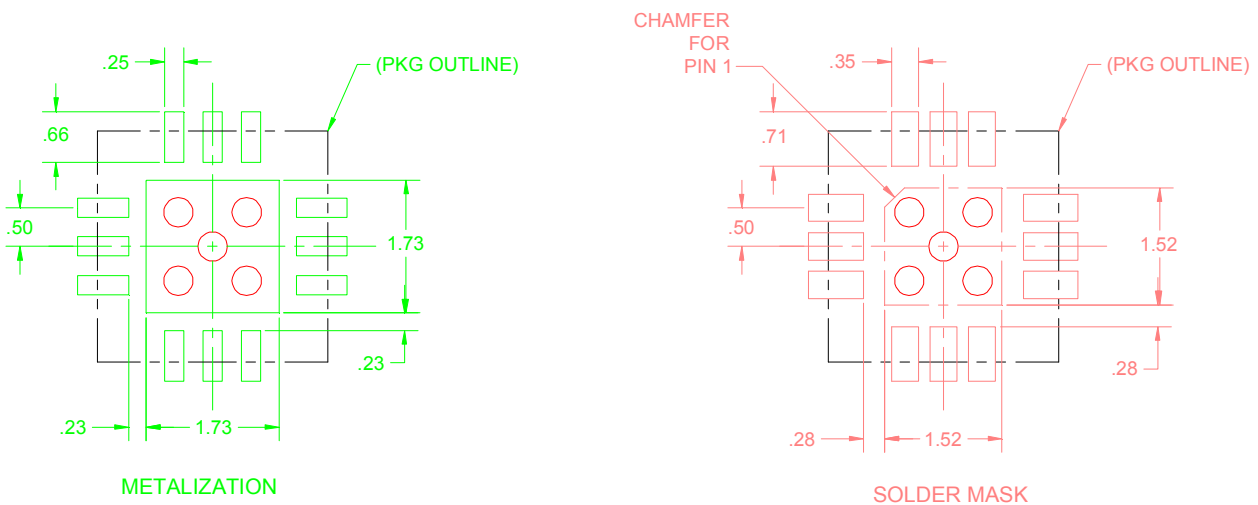

ver 1.4 0616

Pin Description

Pin Diagram

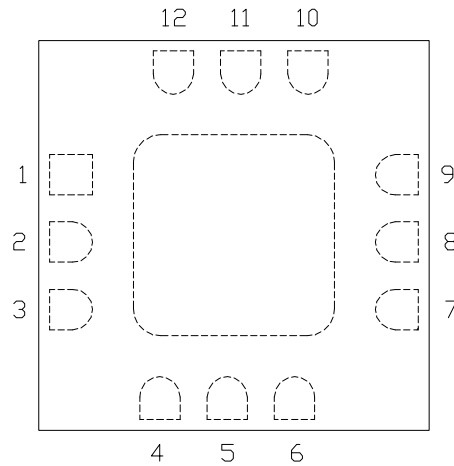

Functional Description

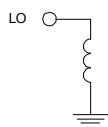
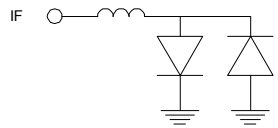
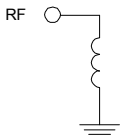
Pin	Function	Description	Schematic
1,3,4,6,7,9 and die paddle	Ground	Connect to RF / DC ground.	
2	LO	This pin is DC coupled and matched to 50 ohms.	
5	IF	This pin is DC coupled. For applications not requiring operation to DC, this port should be DC blocked externally using a series capacitor whose value has been chosen to pass the necessary IF frequency range. For operation to DC, this pin must not source or sink more than 16 mA of current or part non-function or part failure may result.	
8	RF	This pin is DC coupled and matched to 50 ohms.	
10-12	N/C	No connection required. These pins may be connected to RF/DC ground	

ver 1.4 0616

Applications Information

Evaluation Board

The circuit board shown has been developed for optimized assembly at Custom MMIC. A sufficient number of via holes should be used to connect the top and bottom ground planes. As surface mount processes vary, careful process development is recommended.

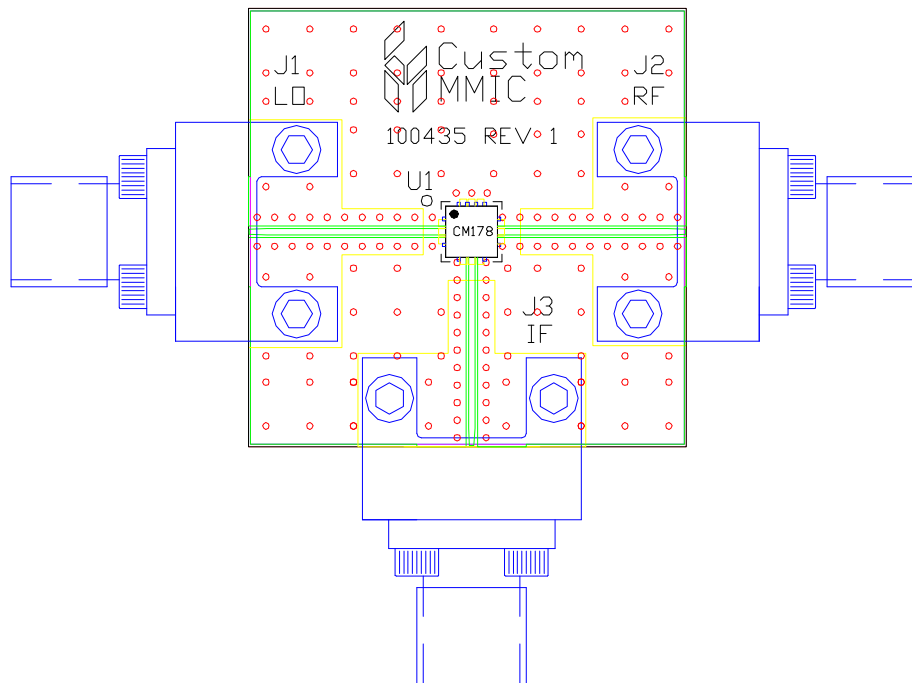

Bill of Material

Designator	Value	Description
J1 - J3		SMA End Launch Connector
U1		CMD178C3 Fundamental Mixer
PCB		100435 Evaluation PCB

GaAs MMIC devices are susceptible to damage from Electrostatic Discharge. Proper precautions should be observed during handling, assembly and test.

ver 1.4 0616