

Features

- ▶ Low phase error
- ▶ Low insertion loss
- ▶ 360° phase shift, LSB = 22.5°
- ▶ Single bit positive logic
- ▶ Pb-free RoHs compliant 4x4 QFN package

Description

The CMD176P4 is a GaAs MMIC 4-bit phase shifter housed in a leadless 4x4 mm plastic surface mount package. The CMD176P4 operates from 13 to 17 GHz and provides 0 to 360 degrees of monotonic phase coverage, with a LSB of 22.5 degrees. The device is controlled with single bit positive logic of 0 or +3 V and features an insertion loss of 8 dB and a phase error of ± 5 degrees. The CMD176P4 is a 50 ohm matched design which eliminates the need for external DC blocks and RF port matching.

Functional Block Diagram

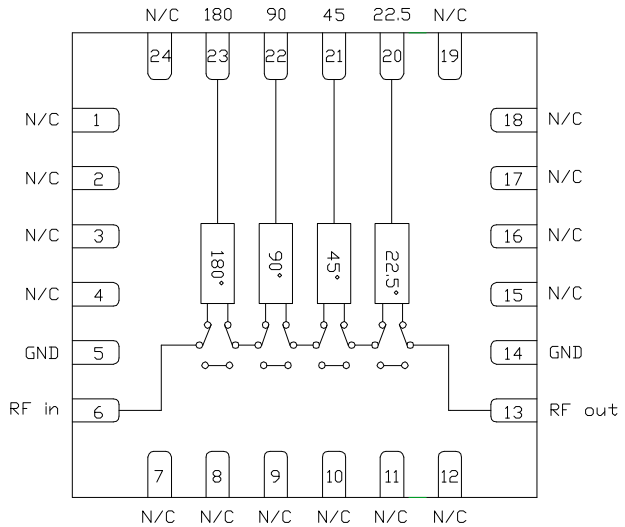

Electrical Performance - $V_{ctl} = 0/+3$ V, $T_A = 25$ °C, $F = 15$ GHz

Parameter	Min	Typ	Max	Units
Frequency Range	13 - 17			GHz
Insertion Loss		8		dB
Input Return Loss		18		dB
Output Return Loss		14		dB
Phase Error		+3 / -1		deg
Input P1dB		26		dBm
Input IP3		41		dBm

ver 1.4 0518



CMD176P4

13-17 GHz 4-Bit Digital Phase Shifter

Specifications

Absolute Maximum Ratings

Parameter	Rating
Control Voltage, Vctl	8.0 V
RF Input Power	+30 dBm
Operating Temperature	-40 to 85 °C
Storage Temperature	-55 to 150 °C

Exceeding any one or combination of the maximum ratings may cause permanent damage to the device.

Recommended Operating Conditions

Parameter	Min	Typ	Max	Units
Vctl	3.0		5.0	V
Iee	0	4	6	mA

Electrical performance is measured at specific test conditions. Electrical specifications are not guaranteed over all recommended operating conditions.

Truth Table

Control Voltage Input				Phase Shift (degrees)
22.5	45	90	180	
Low	Low	Low	Low	Reference
High	Low	Low	Low	22.5
Low	High	Low	Low	45
Low	Low	High	Low	90
Low	Low	Low	High	180
High	High	High	High	337.5

Control Voltage

State	Bias Condition
High	Vctl ± 0.3 V
Low	0 ± 0.3 V

ver 1.4 0518



CMD176P4

13-17 GHz 4-Bit Digital Phase Shifter

Specifications

Electrical Specifications - $V_{ctl} = 0/+3$ V, $T_A = 25$ °C

Parameter	Min	Typ	Max	Min	Typ	Max	Units
Frequency Range	13 - 17			14.4 - 15.6			GHz
Insertion Loss		8.5	10.5		8.5	9.5	dB
Input Return Loss		15			18		dB
Output Return Loss		10			12		dB
Phase Error		± 5	+15 / -10		± 5	± 9	deg
Insertion Loss Variation		± 0.5			± 0.5		dB
Input P1dB		26			26		dBm
Input IP3		40			40		dBm

Note: Specification applies to major states

ver 1.4 0518

Typical Performance

Insertion Loss, Major States, $T_A = 25\text{ }^\circ\text{C}$

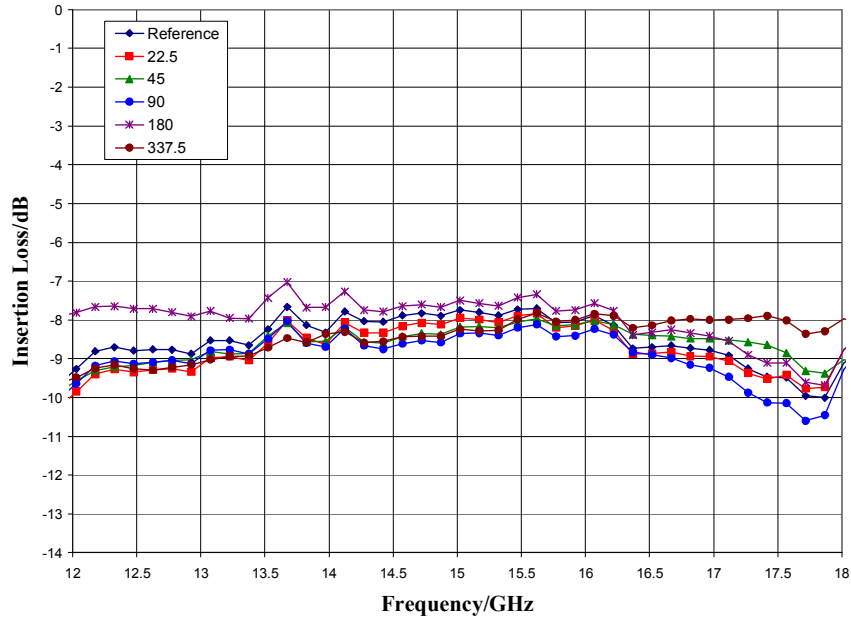

Relative Phase Shift, Major States and All On State, $T_A = 25\text{ }^\circ\text{C}$

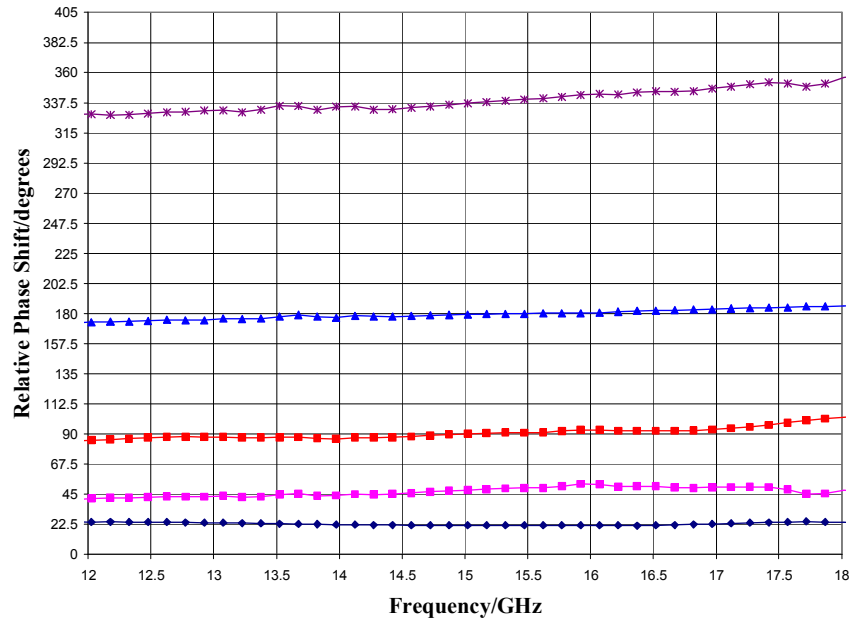

ver 1.4 0518

Typical Performance

Input Return Loss, Major States, $T_A = 25\text{ }^\circ\text{C}$

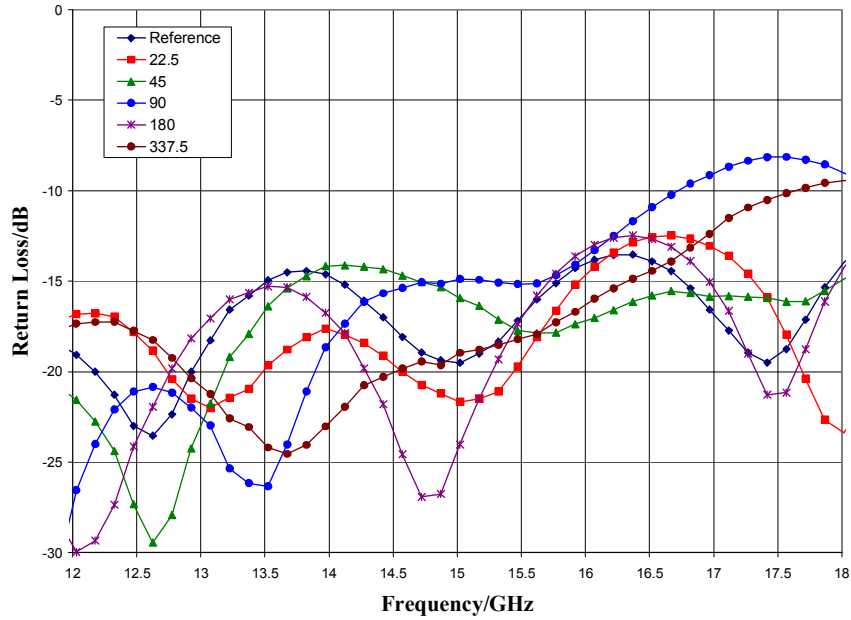

Output Return Loss, Major States, $T_A = 25\text{ }^\circ\text{C}$

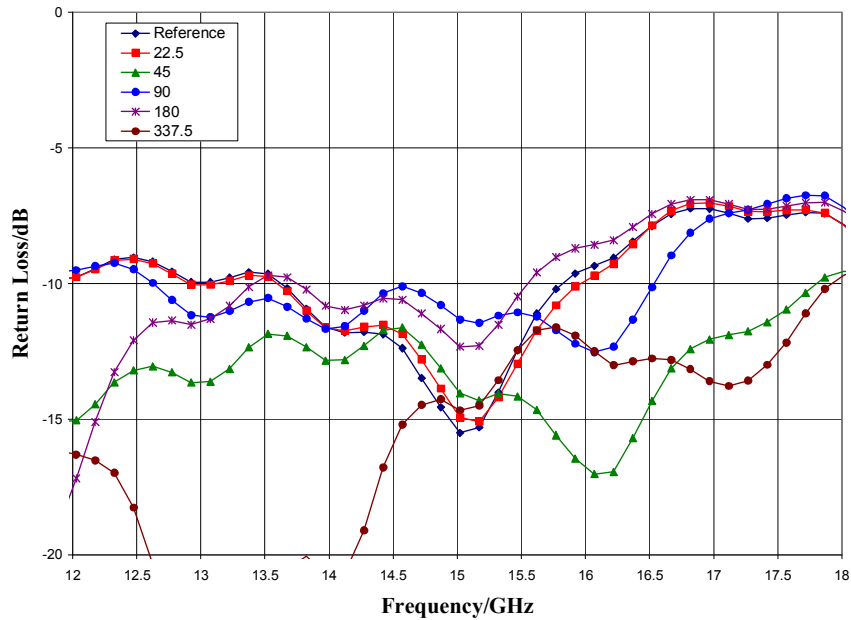

ver 1.4 0518

Typical Performance

Normalized Loss, Major States

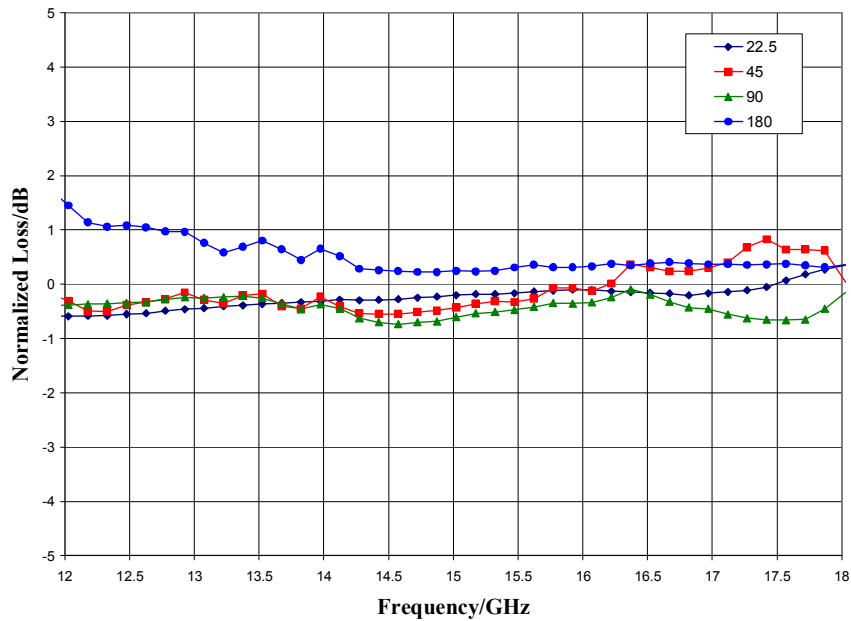

Phase Error, Major States and All On State

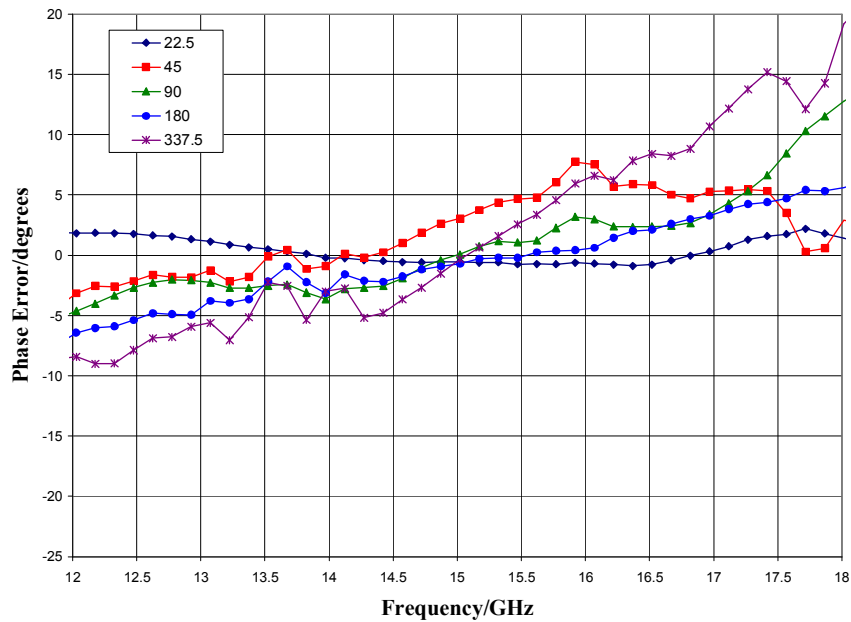

ver 1.4 0518

Typical Performance

Insertion Loss vs. Temperature, Reference State

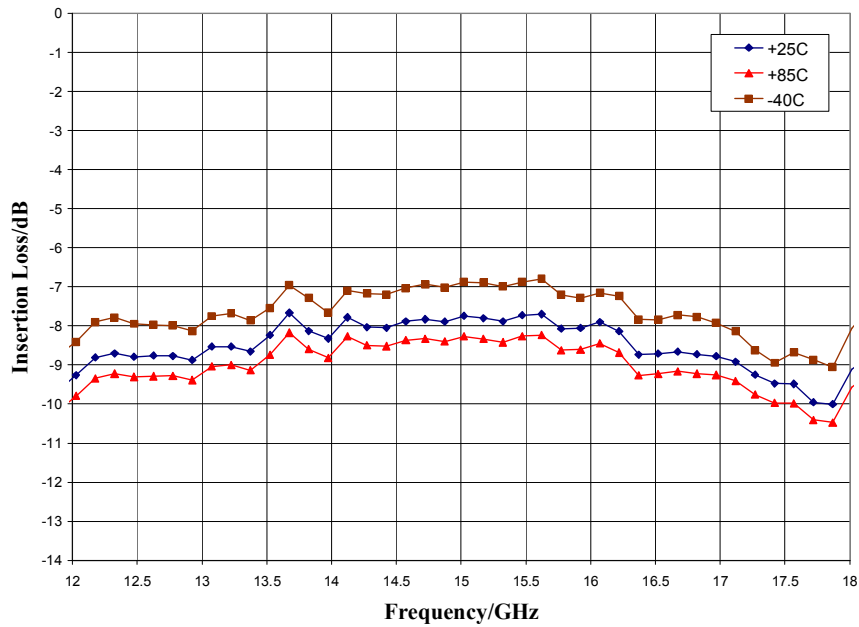

Input P1dB

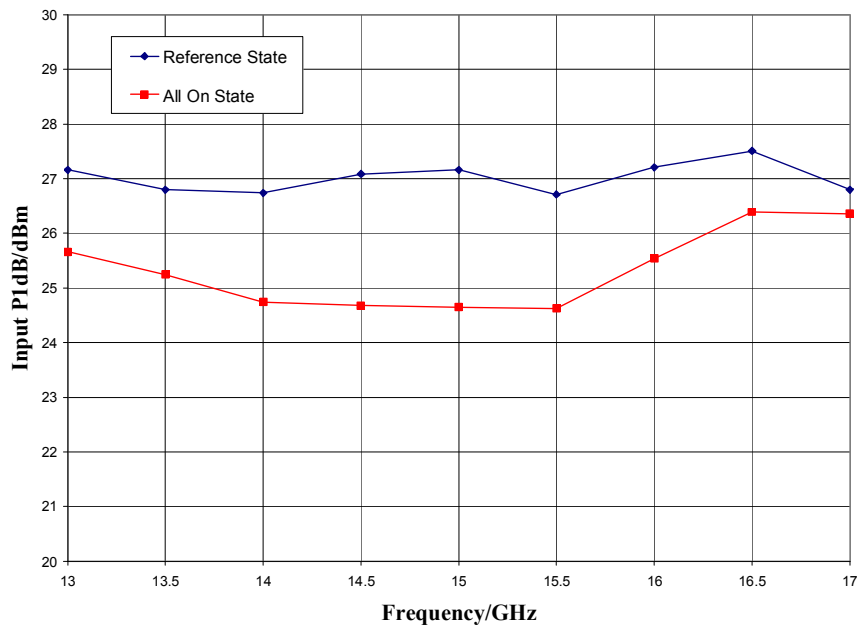

ver 1.4 0518

Typical Performance

Input IP3

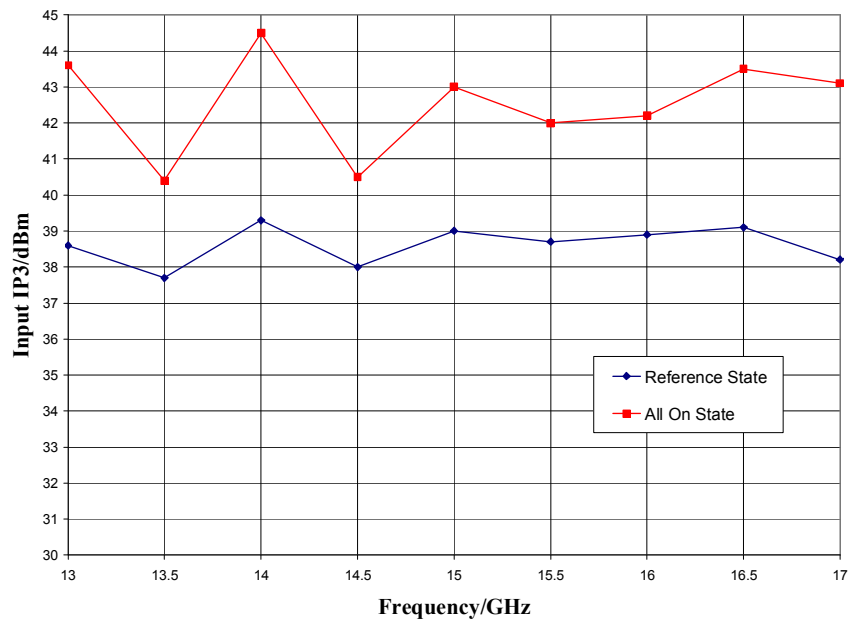

Mechanical Information

Package Information and Dimensions

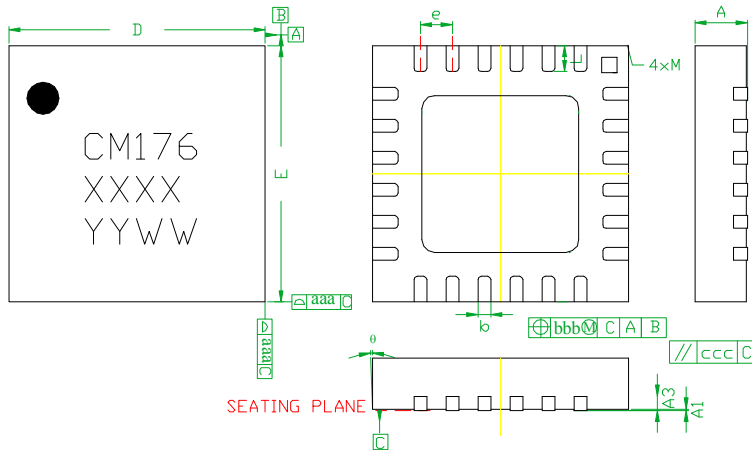

SYMBOLS	DIMENSIONS IN MILLIMETERS		
	MIN	NOM	MAX
A	0.80	0.90	1.00
A1	0	0.02	0.05
A3	---	0.25REF.	---
b	0.18	0.23	0.30
D	3.85	4.00	4.15
D1	---	2.45BSC	---
E	3.85	4.00	4.15
E1	---	2.45BSC	---
e	---	0.50BSC	---
L	0.30	0.40	0.50
theta	0	---	12
aaa	---	0.25	---
bbb	---	0.10	---
ccc	---	0.10	---
M	---	---	0.05

NOTES:

1. DIMENSIONS ARE IN MILLIMETERS
2. RoHS COMPLIANT MOLD COMPOUND
3. LEADFRAME MATERIAL: COPPER ALLOY
4. LEAD FINISH: 100% MATTE Sn
5. INDICATED DIMENSION/TOLERANCE APPLIES TO LEADS AND EXPOSED PAD

Recommended PCB Land Pattern

Custom MMIC Design Services recommends that the user develop the land pattern that will provide the best design for proper solder reflow and device attach for their specific application. Please review CMDS Application Note AN 105 for a recommended land pattern approach.

Recommended Solder Reflow Profile

Custom MMIC Design Services recommends screen printing with belt furnace reflow to ensure proper solder reflow and device attach. Please review CMDS Application Note AN 102 for a recommended solder reflow profile.

GaAs MMIC devices are susceptible to damage from Electrostatic Discharge. Proper precautions should be observed during handling, assembly and test.



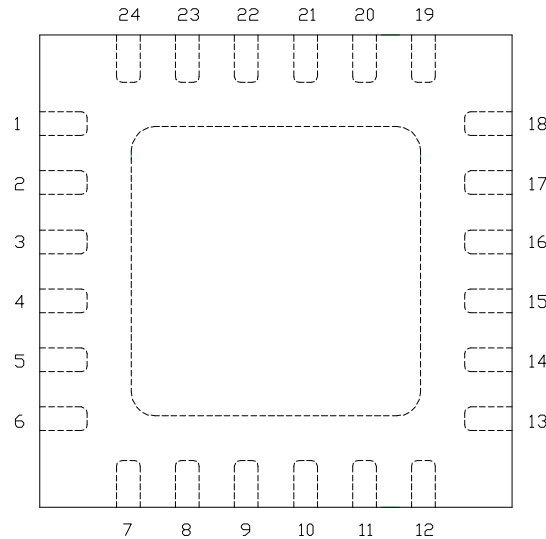

ver 1.4 0518

Pin Description

Pin Diagram

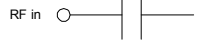

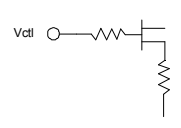
Functional Description

Pad	Function	Description	Schematic
1-4, 7-12, 15-19, 24	N/C	No connection required. These pins may be connected to RF / DC ground	
6	RF in	DC blocked and 50 ohm matched	
13	RF out	DC blocked and 50 ohm matched	
20	22.5	22.5° control input	
21	45	45° control input	
22	90	90° control input	
23	180	180° control input	
5, 14 and die pad-dle	Ground	Connect to RF / DC ground	

Applications Information

Evaluation Board

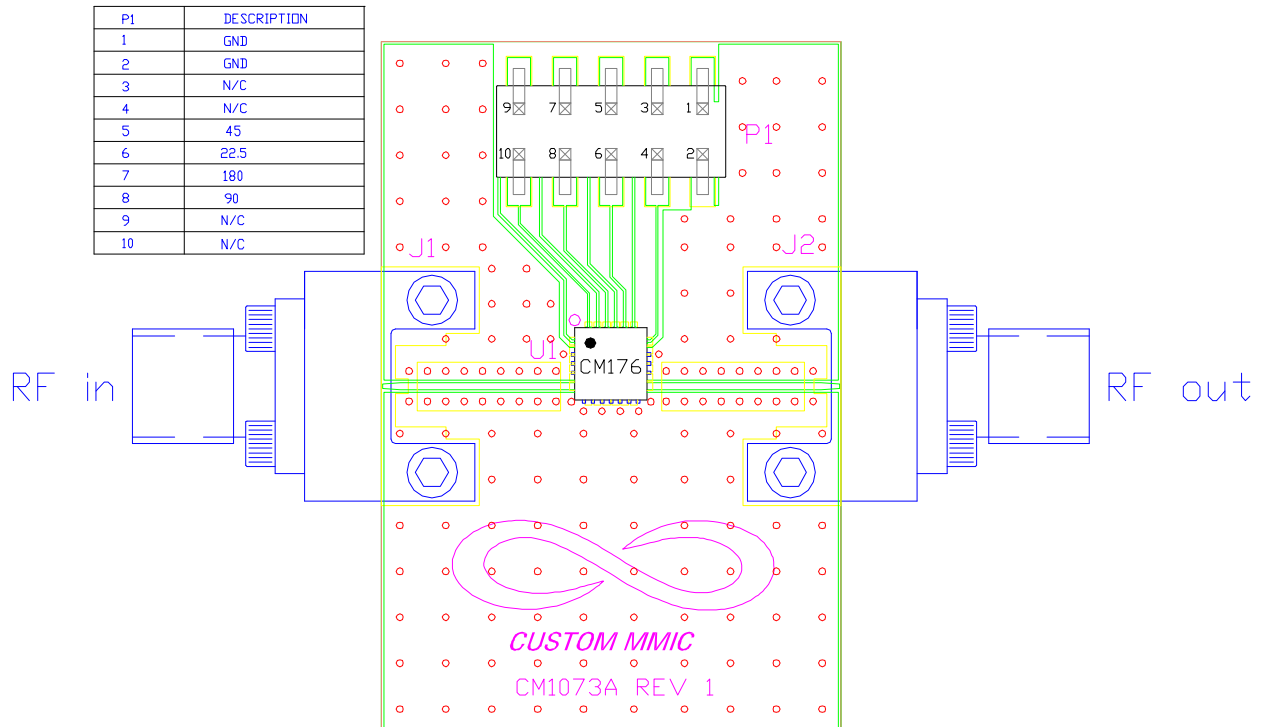

Bill of Material

Designator	Value	Description
J1, J2		SMA End Launch Connector
P1		10 Pin DC Header
U1		CMD176P4 4-Bit Phase Shifter
PCB		CM1073A Evaluation PCB