



# CMD174P4

## 3-6 GHz 5-Bit Digital Phase Shifter

### Features

- ▶ Low phase error
- ▶ Low insertion loss
- ▶ 360° phase shift, LSB = 11.25°
- ▶ Single bit negative logic
- ▶ Pb-free RoHs compliant 4x4 QFN package

### Description

The CMD174P4 is a GaAs MMIC 5-bit phase shifter housed in a leadless 4x4 mm plastic surface mount package. The CMD174P4 operates from 3 to 6 GHz and provides 0 to 360 degrees of monotonic phase coverage, with a LSB of 11.25 degrees. The device is controlled with single bit negative logic of 0 or -3 V and features an insertion loss of 7.6 dB and a phase error of  $\pm 2$  degrees. The CMD174P4 is a 50 ohm matched design which eliminates the need for external DC blocks and RF port matching.

### Functional Block Diagram

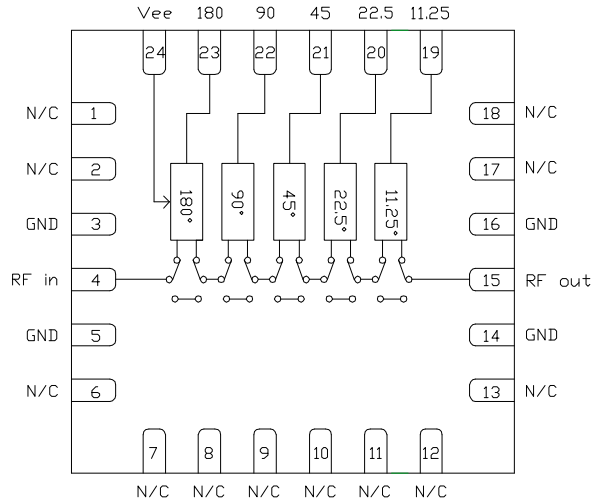

### Electrical Performance - $V_{ee} = -3$ V, $V_{ctl} = 0/-3$ V, $T_A = 25$ °C, $F = 4.5$ GHz

Parameter	Min	Typ	Max	Units
Frequency Range		3 - 6		GHz
Insertion Loss		7.6		dB
Input Return Loss		15		dB
Output Return Loss		20		dB
Phase Error		$\pm 2$		deg
Input P1dB		26.5		dBm
Supply Current		4		mA

ver 1.3 0516



# CMD174P4

## 3-6 GHz 5-Bit Digital Phase Shifter

### Specifications

#### Absolute Maximum Ratings

Parameter	Rating
Supply Voltage, V <sub>ee</sub>	-8.0 V
RF Input Power	+30 dBm
Operating Temperature	-40 to 85 °C
Storage Temperature	-55 to 150 °C

Operation of this device outside the maximum ratings may cause permanent damage.

#### Recommended Operating Conditions

Parameter	Min	Typ	Max	Units
V <sub>ee</sub>	-5.0		-3.0	V
I <sub>ee</sub>		4		mA

Electrical performance is measured at specific test conditions. Electrical specifications are not guaranteed over all recommended operating conditions.

#### Truth Table

Control Voltage Input					Phase Shift (degrees)
11.25	22.5	45	90	180	
High	High	High	High	High	Reference
Low	High	High	High	High	11.25
High	Low	High	High	High	22.5
High	High	Low	High	High	45
High	High	High	Low	High	90
High	High	High	High	Low	180
Low	Low	Low	Low	Low	348.75

#### Control Voltage

State	Bias Condition
High	V <sub>ee</sub> ± 0.3 V
Low	0 ± 0.3 V

ver 1.3 0516



# CMD174P4

## 3-6 GHz 5-Bit Digital Phase Shifter

### Specifications

Electrical Specifications -  $V_{ee} = -3.0$  V,  $V_{ctl} = 0/-3$  V,  $T_A = 25$  °C

Parameter	Min	Typ	Max	Min	Typ	Max	Min	Typ	Max	Units
Frequency Range	3 - 3.5			3.5 - 5			5 - 6			GHz
Insertion Loss		8.5	11		7.6	9		8.5	10	dB
Input Return Loss		17			17			12		dB
Output Return Loss		17			17			12		dB
Phase Error		+5 / -1	+13 / -5		± 2	+7 / -5		± 4	± 8	deg
Insertion Loss Variation		± 0.5			± 0.25			± 0.5		dB
Input P1dB		26.5			26.5			26		dBm
Input IP3		38			37			37		dBm
Supply Current		4			4			4		mA

Note: Specification applies to major states

ver 1.3 0516

### Typical Performance

Insertion Loss, Major States,  $V_{ee} = -3.0\text{ V}$ ,  $T_A = 25\text{ }^\circ\text{C}$

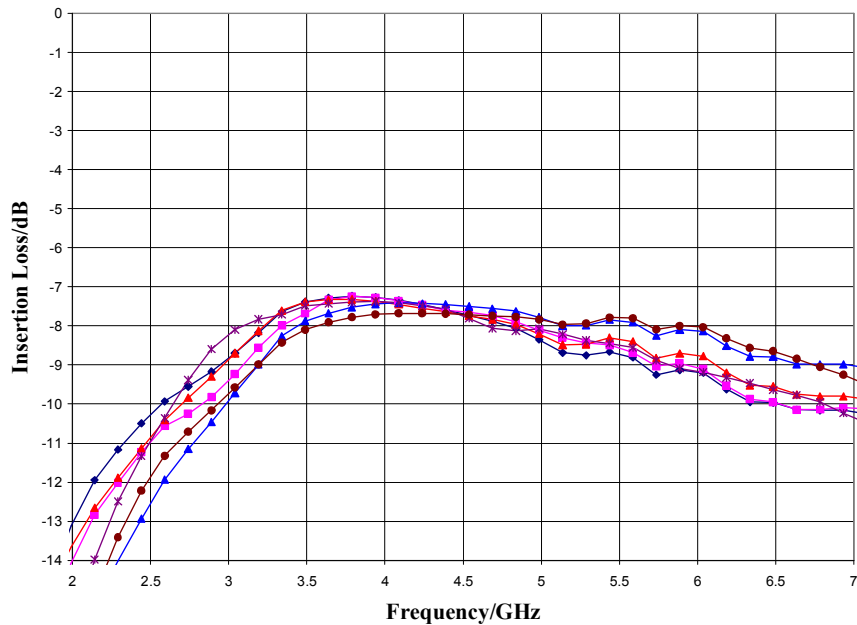

Relative Phase Shift, Major States and All On State,  $V_{ee} = -3.0\text{ V}$ ,  $T_A = 25\text{ }^\circ\text{C}$

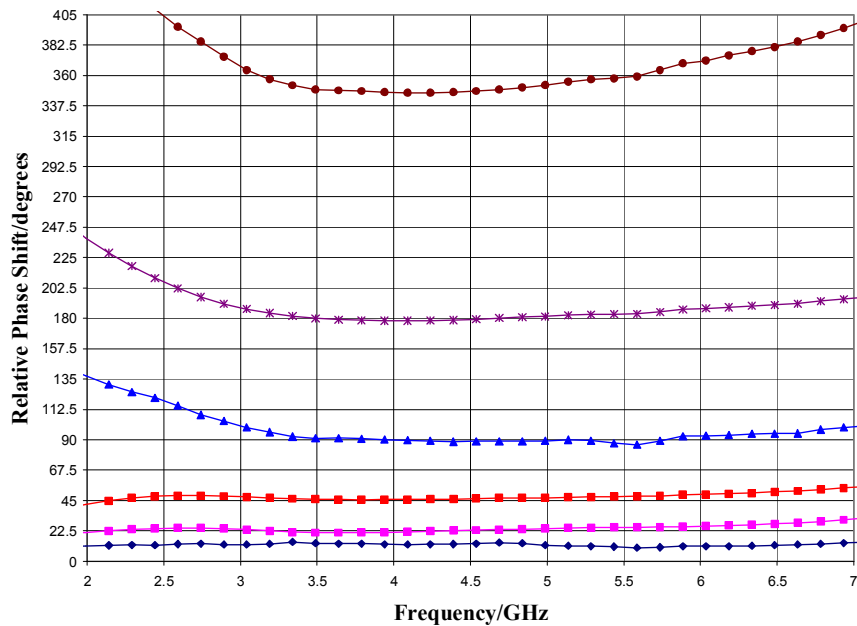

ver 1.3 0516

### Typical Performance

Input Return Loss, Major States,  $V_{cc} = -3.0\text{ V}$ ,  $T_A = 25\text{ }^\circ\text{C}$

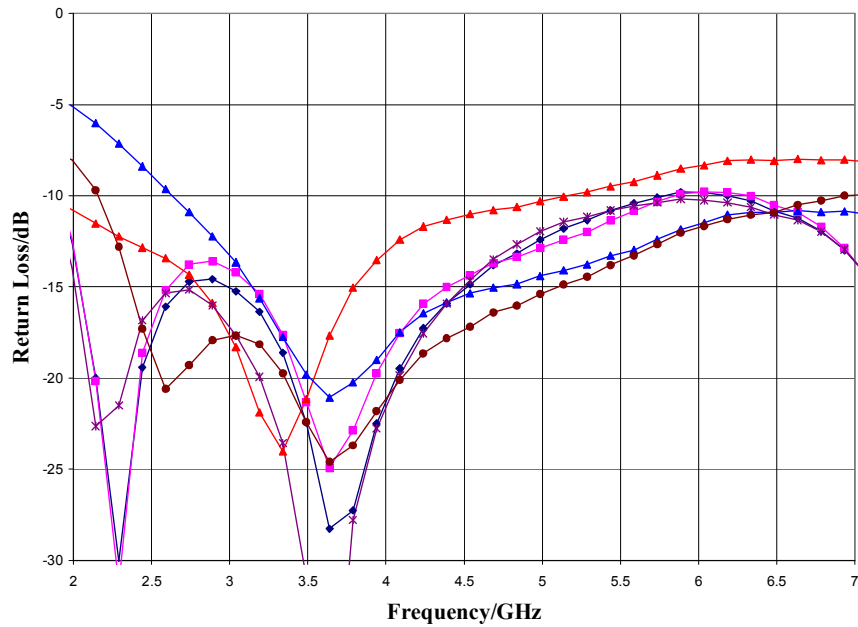

Output Return Loss, Major States,  $V_{cc} = -3.0\text{ V}$ ,  $T_A = 25\text{ }^\circ\text{C}$

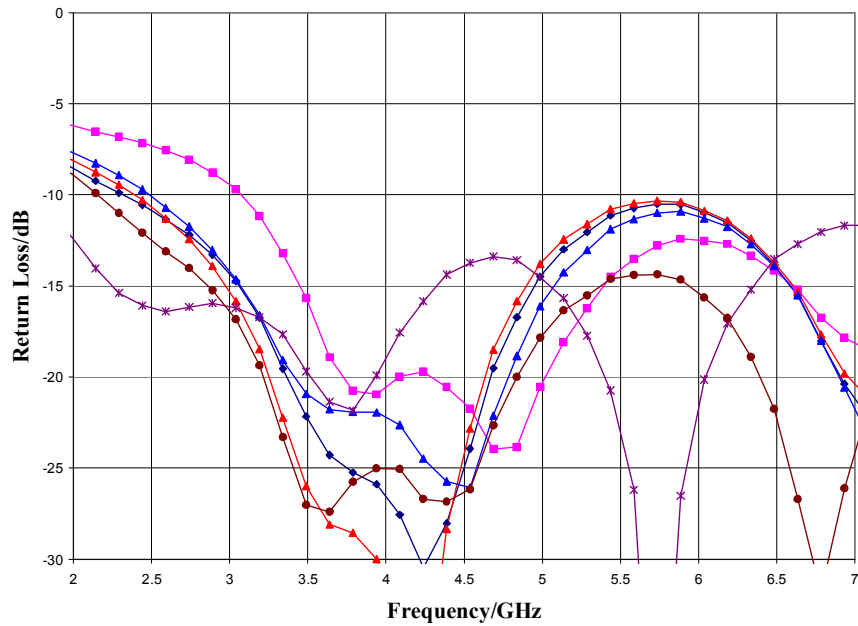

ver 1.3 0516

### Typical Performance

Normalized Loss, Major States,  $V_{ee} = -3.0$  V

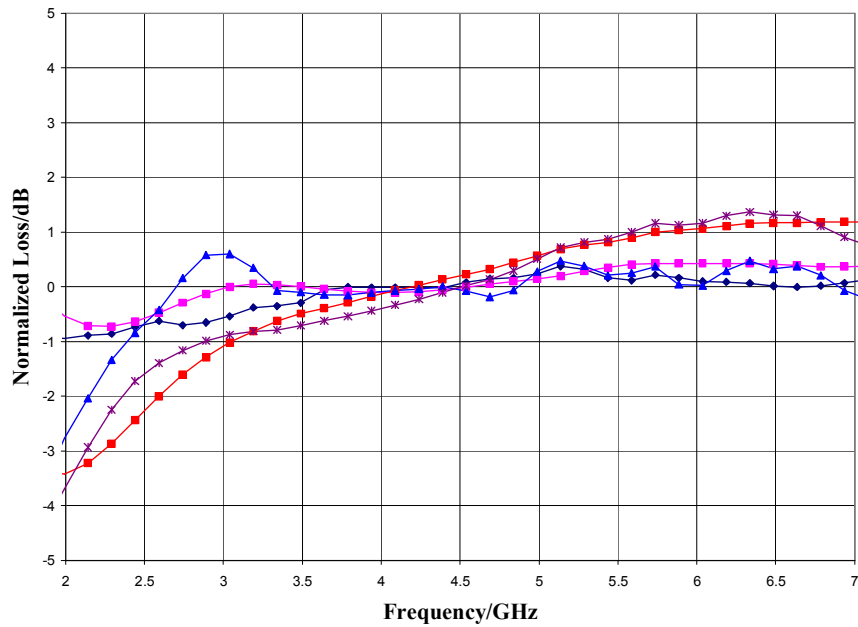

Phase Error, Major States and All On State,  $V_{ee} = -3.0$  V

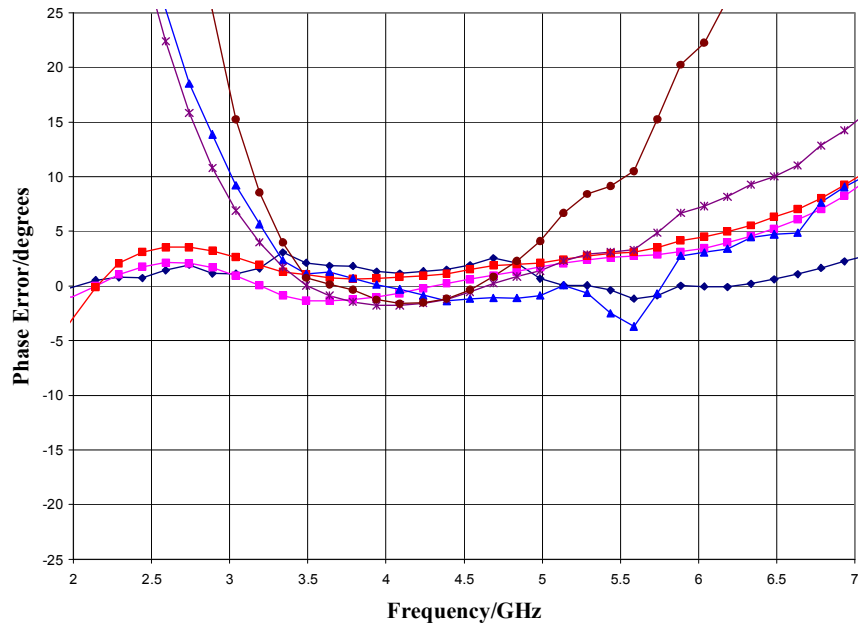

ver 1.3 0516

### Typical Performance

**Insertion Loss vs. Temperature, Reference State,  $V_{ee} = -3.0$  V**

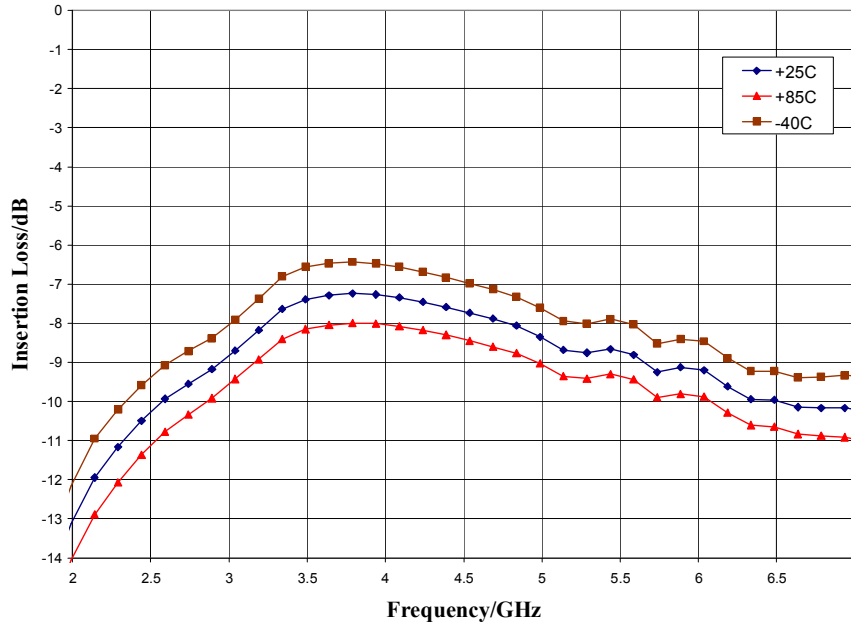

**Input P1dB,  $V_{ee} = -3.0$  V**

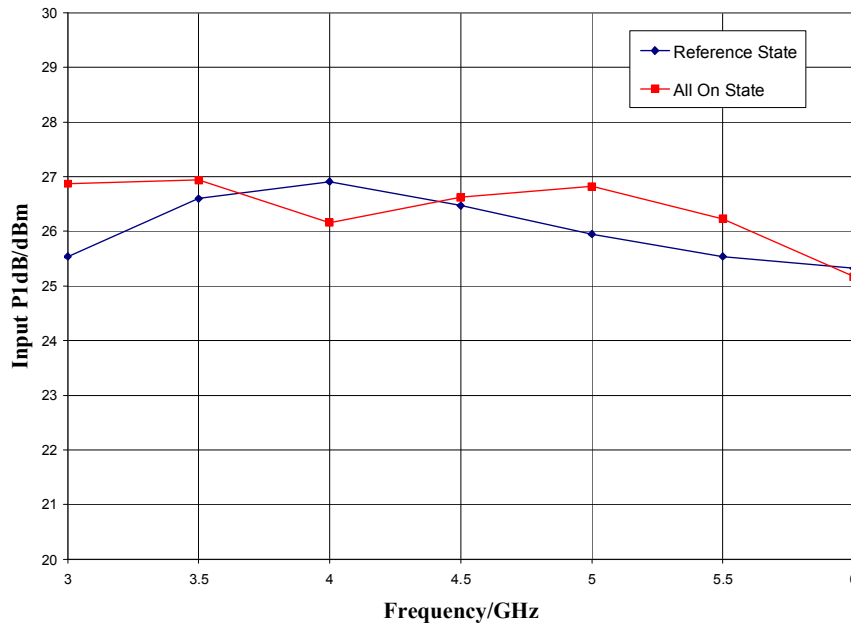

ver 1.3 0516

### Typical Performance

Input IP3,  $V_{cc} = -3.0$  V

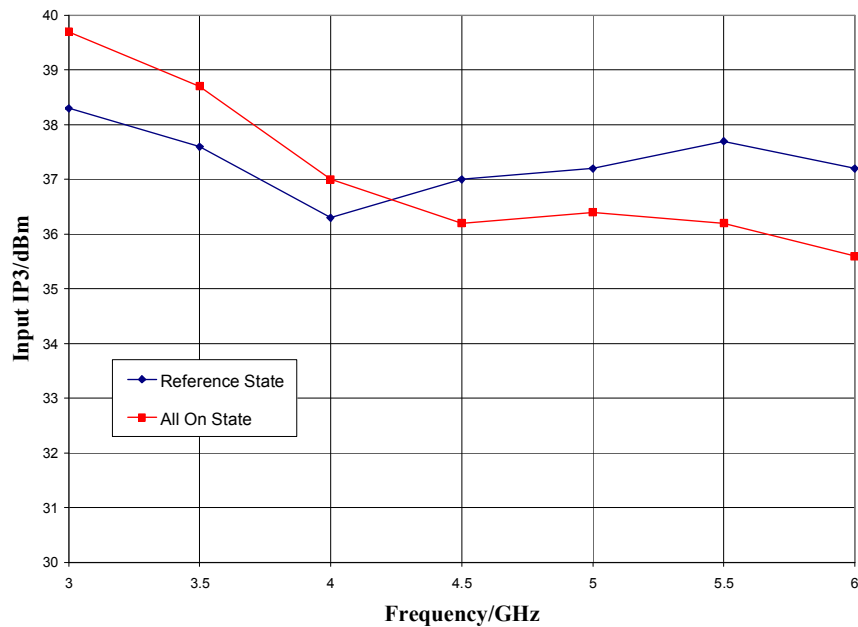



### Mechanical Information

#### Package Information and Dimensions

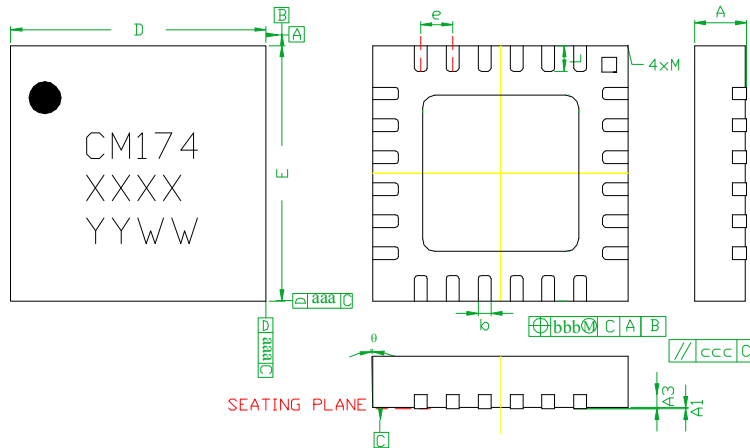

SYMBOLS	DIMENSIONS IN MILLIMETERS		
	MIN	NOM	MAX
A	0.80	0.90	1.00
A1	0	0.02	0.05
A3	---	0.25REF.	---
b	0.18	0.23	0.30
D	3.85	4.00	4.15
D1	---	2.45BSC	---
E	3.85	4.00	4.15
E1	---	2.45BSC	---
e	---	0.50BSC	---
L	0.30	0.40	0.50
theta	0	---	12
aaa	---	0.25	---
bbb	---	0.10	---
ccc	---	0.10	---
M	---	---	0.05

**NOTES:**

1. DIMENSIONS ARE IN MILLIMETERS
2. RoHS COMPLIANT MOLD COMPOUND
3. LEADFRAME MATERIAL: COPPER ALLOY
4. LEAD FINISH: 100% MATTE Sn
5. INDICATED DIMENSION/TOLERANCE APPLIES TO LEADS AND EXPOSED PAD

#### Recommended PCB Land Pattern

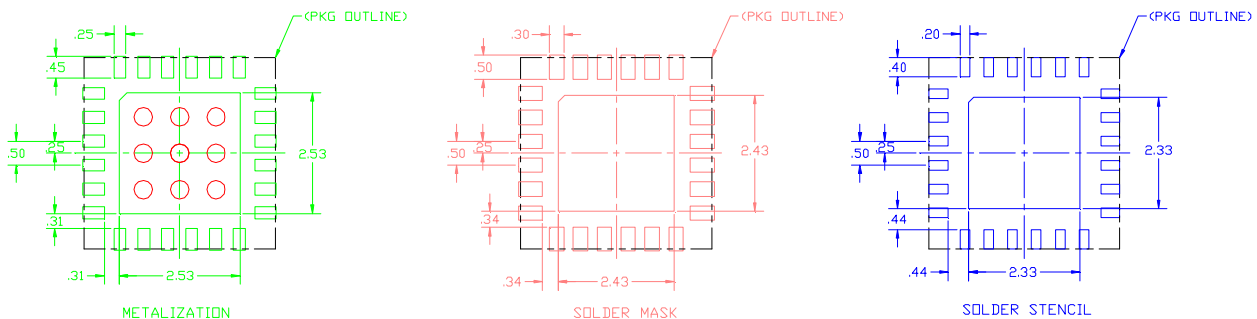

**GaAs MMIC devices are susceptible to damage from Electrostatic Discharge. Proper precautions should be observed during handling, assembly and test.**



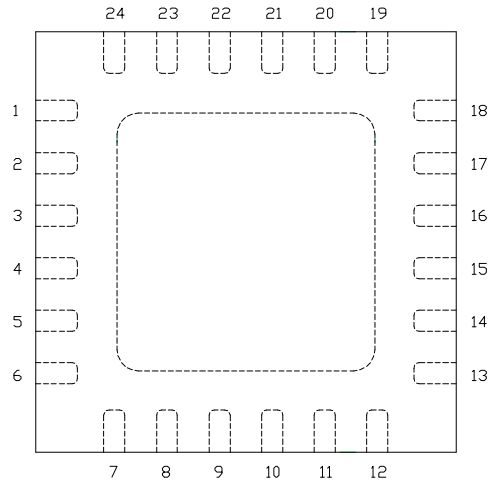

ver 1.3 0516

### Pin Description

#### Pin Diagram

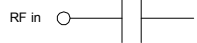

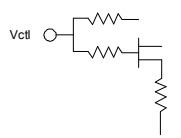
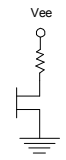
#### Functional Description

Pad	Function	Description	Schematic
1, 2, 6-13, 17, 18	N/C	No connection required. These pins may be connected to RF / DC ground	
4	RF in	DC blocked and 50 ohm matched	RF in 
15	RF out	DC blocked and 50 ohm matched	 RF out
19	11.25	11.25° control input	
20	22.5	22.5° control input	
21	45	45° control input	
22	90	90° control input	
23	180	180° control input	
24	Vee	Supply Voltage	
3,5,14,16 and die paddle	Ground	Connect to RF / DC ground	

ver 1.3 0516

### Applications Information

#### Evaluation Board

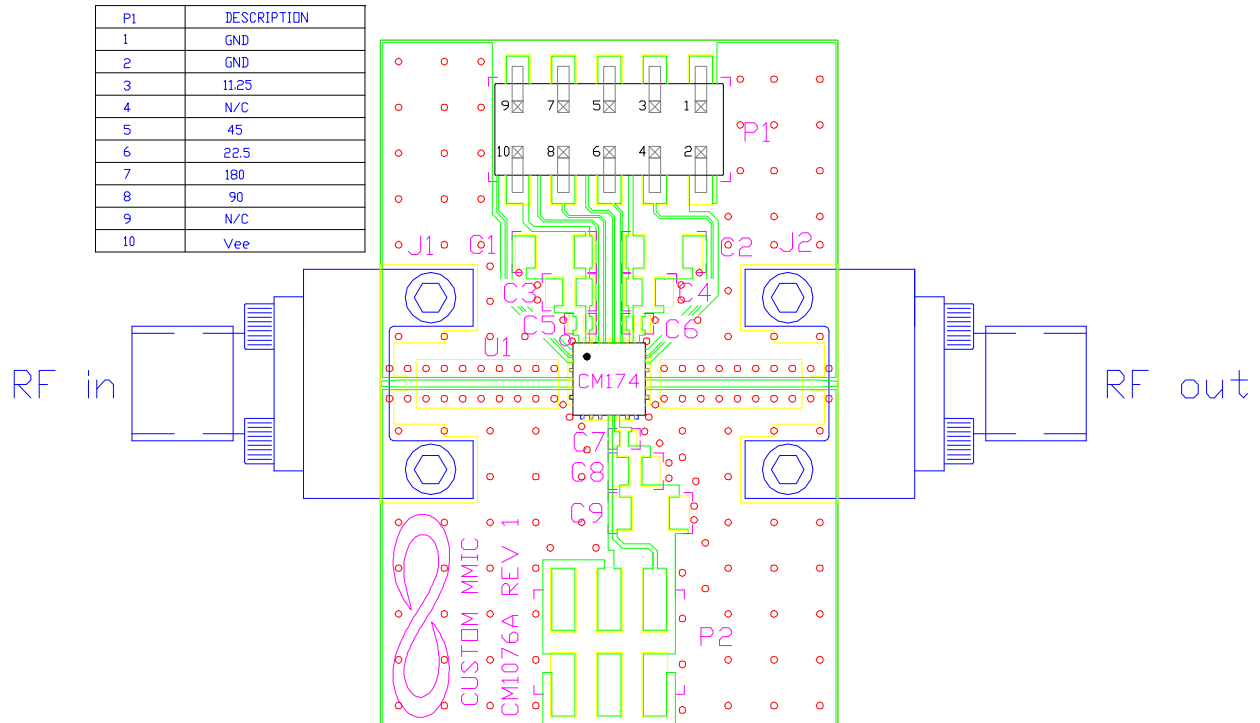

#### Bill of Material

Designator	Value	Description
J1, J2		SMA End Launch Connector
P1		10 Pin DC Header
U1		CMD174P4 5-Bit Phase Shifter
PCB		CM1076A Evaluation PCB