



CMD170P4

7.5-9 GHz Driver Amplifier

Features

- ▶ High output power
- ▶ On-chip detector
- ▶ All positive bias
- ▶ Pb-free RoHs compliant 4x4 QFN package

Description

The CMD170P4 is a GaAs MMIC driver amplifier housed in a leadless 4x4 mm plastic surface mount package. The CMD170P4 is ideally suited for complex communications systems where small size and high linearity are needed. At 8 GHz the device delivers 30 dB of gain with a corresponding output 1 dB compression point of greater than +28 dBm. The CMD170P4 is a 50 ohm matched design which eliminates the need for external DC blocks and RF port matching. The CMD170P4 is also equipped with an on-chip detector for applications where power leveling is required.

Functional Block Diagram

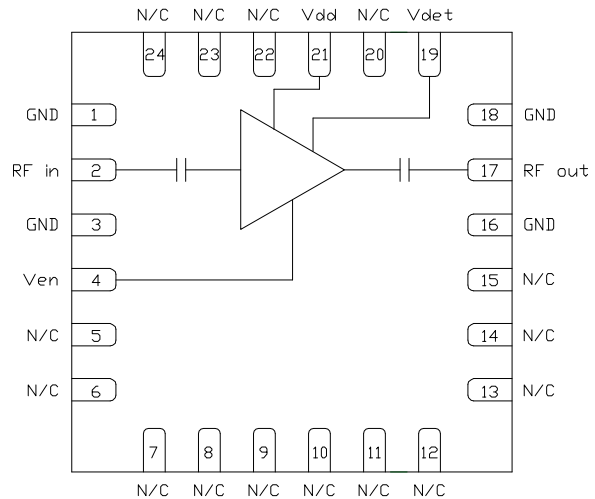

Electrical Performance - $V_{dd} = 7.0\text{ V}$, $V_{en} = 3.0\text{ V}$, $T_A = 25\text{ }^\circ\text{C}$, $F = 8\text{ GHz}$

Parameter	Min	Typ	Max	Units
Frequency Range	7.5 - 9			GHz
Gain		30		dB
Input Return Loss		12		dB
Output Return Loss		17		dB
Output P1dB		28.3		dBm
Supply Current ($V_{dd} = 7\text{ V}$)		365		mA
Enable Current ($V_{en} = 3\text{ V}$)		19		mA

ver 1.2 0516

Specifications

Absolute Maximum Ratings

Parameter	Rating
Drain Voltage, Vdd	8.0 V
Enable Voltage, Ven	4.0 V
RF Input Power	+20 dBm
Channel Temperature, Tch	150 °C
Power Dissipation, Pdiss	3.62 W
Thermal Resistance	17.9 °C/W
Operating Temperature	-40 to 85 °C
Storage Temperature	-55 to 150 °C

Operation of this device outside the maximum ratings may cause permanent damage.

Recommended Operating Conditions

Parameter	Min	Typ	Max	Units
Vdd	5.0	7.0	8.0	V
Idd		365		mA
Ven	0	3.0	4.0	V
Ien		19		mA

Electrical performance is measured at specific test conditions. Electrical specifications are not guaranteed over all recommended operating conditions.

Electrical Specifications - V_{dd} = 7.0 V, Ven=3.0 V T_A = 25 °C

Parameter	Min	Typ	Max	Min	Typ	Max	Units
Frequency Range	7.5 - 9			7.9 - 8.4			GHz
Gain	26	30	33	27	30	33	dB
Input Return Loss		10			10		dB
Output Return Loss		16			16		dB
Output P1dB	26.5	28		27	28.3		dBm
Output IP3		34			34		dBm
Supply Current	335	365	395	335	365	395	mA
Enable Current		19			19		mA
Gain Temperature Coefficient		0.03			0.03		dB/°C

Typical Performance

Broadband Performance, $V_{dd} = 7.0$ V, $V_{en} = 3.0$ V, $I_{dd} = 365$ mA, $T_A = 25$ °C

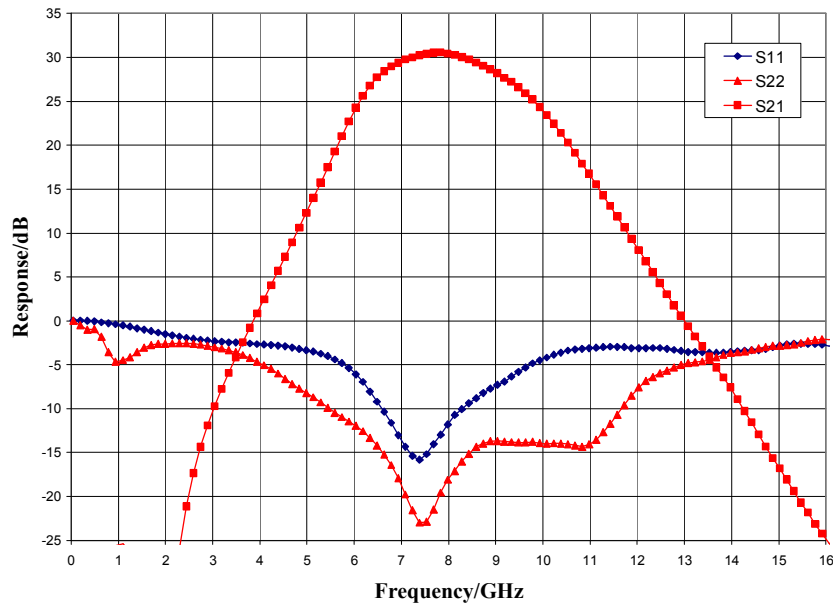

Narrow-band Performance, $V_{dd} = 7.0$ V, $V_{en} = 3.0$ V, $I_{dd} = 365$ mA, $T_A = 25$ °C

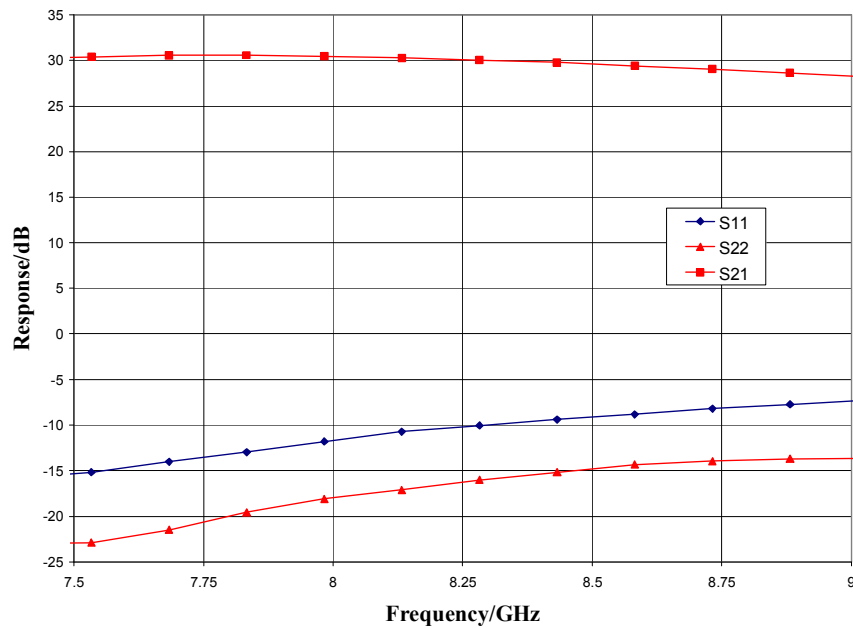

ver 1.2 0516

Typical Performance

Gain vs. Temperature, $V_{dd} = 7.0\text{ V}$, $V_{en} = 3.0\text{ V}$

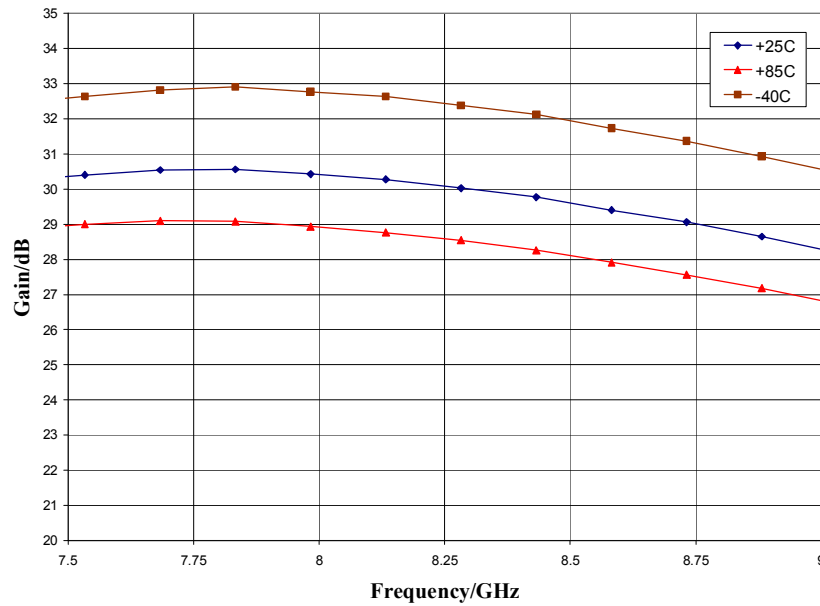

Output Power, $V_{dd} = 7.0\text{ V}$, $V_{en} = 3.0\text{ V}$, $T_A = 25\text{ }^\circ\text{C}$

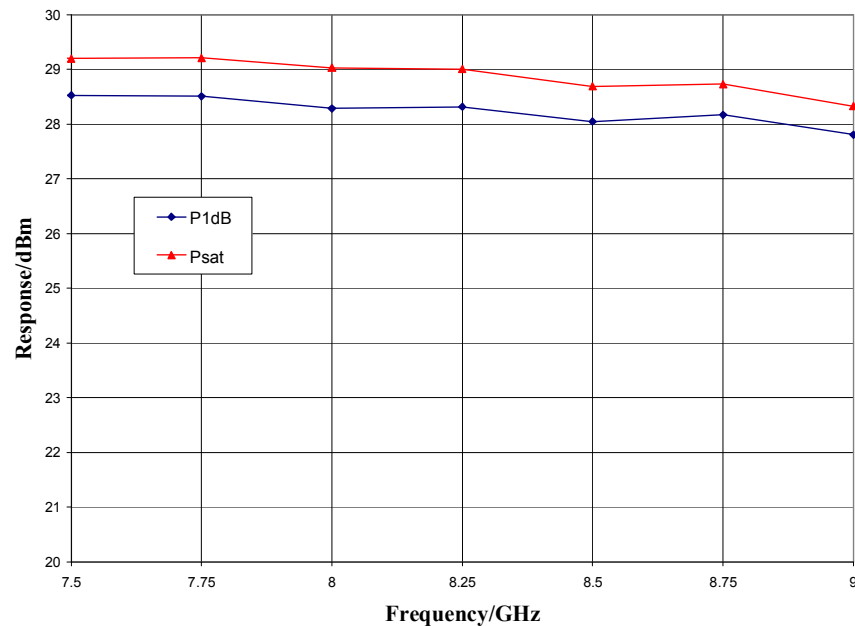

ver 1.2 0516

Typical Performance

P1dB vs. Temperature, $V_{dd} = 7.0\text{ V}$, $V_{en} = 3.0\text{ V}$

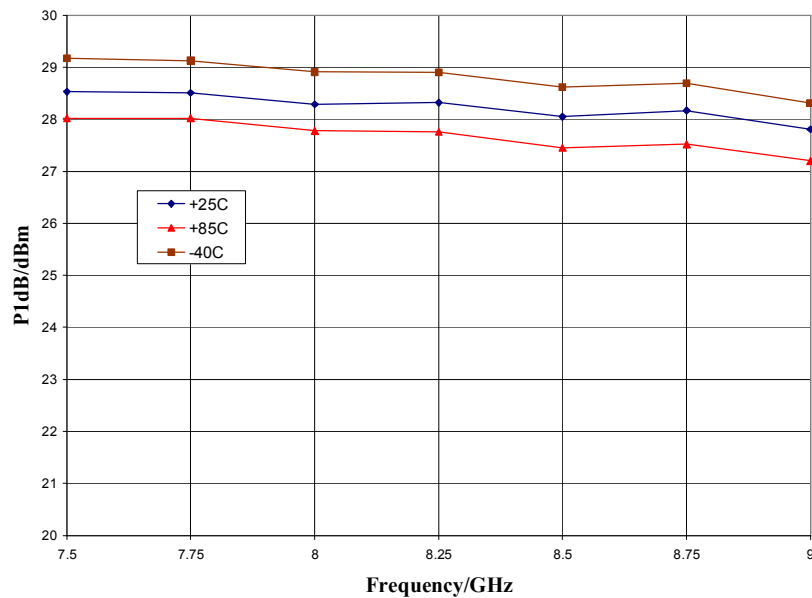

Output IP3 vs. Temperature, $V_{dd} = 7.0\text{ V}$, $V_{en} = 3.0\text{ V}$

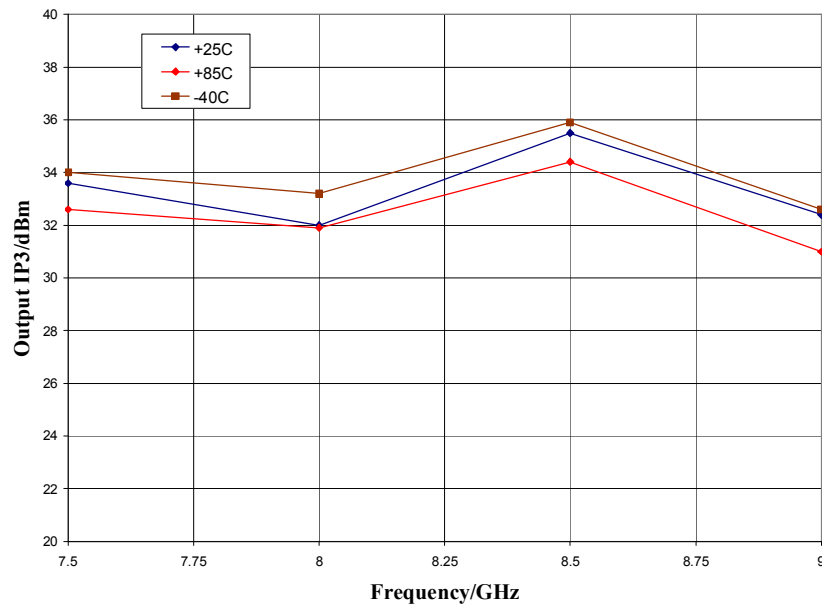

ver 1.2 0516

Mechanical Information

Package Information and Dimensions

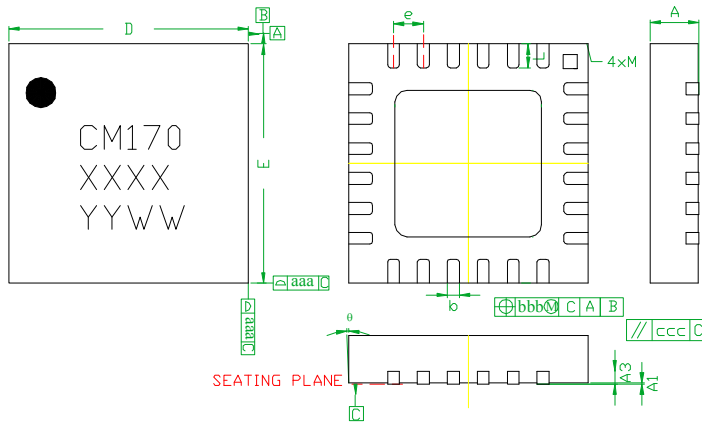

SYMBOLS	DIMENSIONS IN MILLIMETERS		
	MIN	NOM	MAX
A	0.80	0.90	1.00
A1	0	0.02	0.05
A3	—	0.25REF.	—
b	0.18	0.23	0.30
D	3.85	4.00	4.15
D1	—	2.45BSC	—
E	3.85	4.00	4.15
E1	—	2.45BSC	—
e	—	0.50BSC	—
L	0.30	0.40	0.50
ø	0	—	12
aaa	—	0.25	—
bbb	—	0.10	—
ccc	—	0.10	—
M	—	—	0.05

NOTES:

1. DIMENSIONS ARE IN MILLIMETERS
2. RoHS COMPLIANT MOLD COMPOUND
3. LEADFRAME MATERIAL: COPPER ALLOY
4. LEAD FINISH: 100% MATTE Sn
5. INDICATED DIMENSION/TOLERANCE APPLIES TO LEADS AND EXPOSED PAD

Recommended PCB Land Pattern

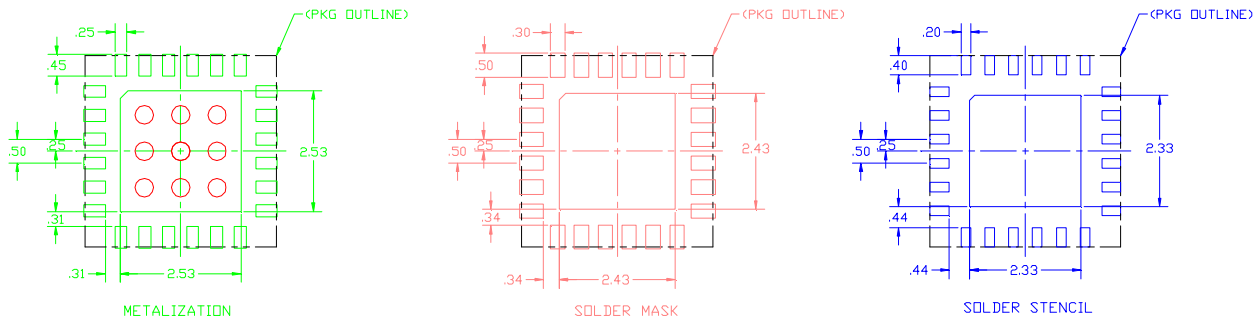



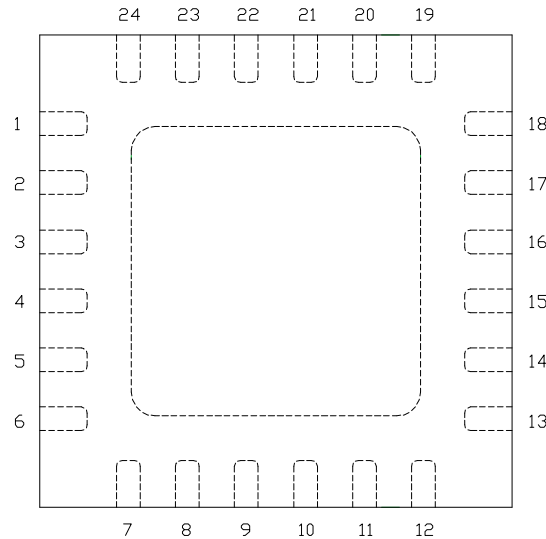

ver 1.2 0516

Pin Description

Pin Diagram

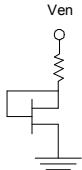

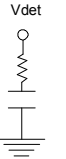
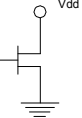
Functional Description

Pad	Function	Description	Schematic
2	RF in	DC blocked and 50 ohm matched	
4	Ven	Power supply enable voltage Decoupling and bypass caps required	
17	RF out	DC blocked and 50 ohm matched	
19	Vdet	Detector voltage	
21	Vdd	Power supply voltage Decoupling and bypass caps required	
1,3,16,18 and die paddle	Ground	Connect to RF / DC ground	

ver 1.2 0516

Applications Information

Application Circuit

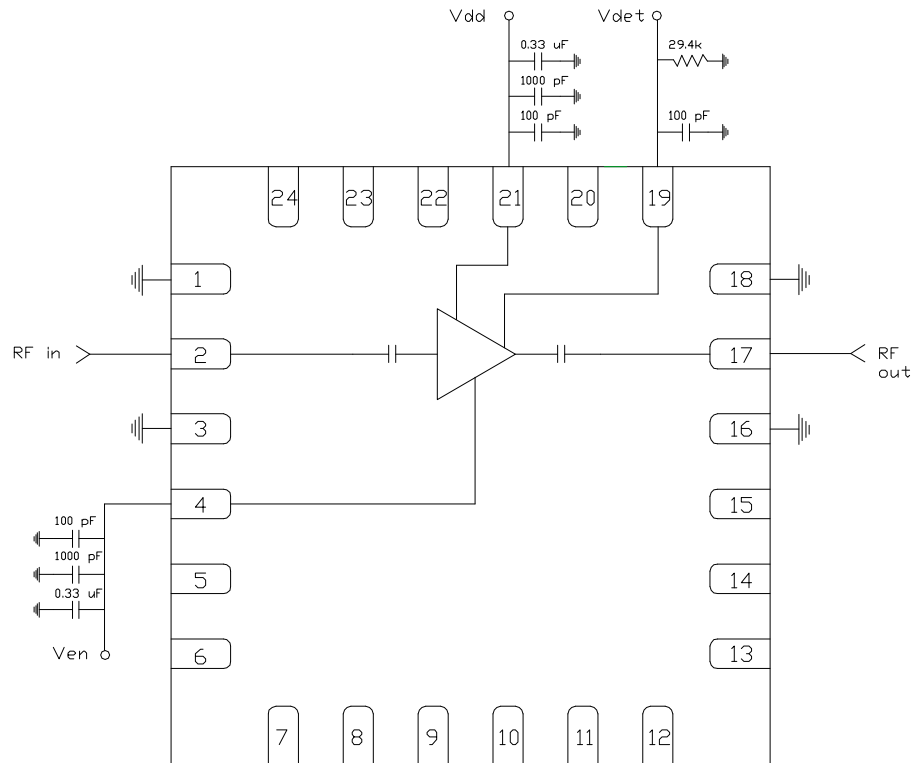

Biasing and Operation

The CMD170P4 is biased with a positive drain supply and positive enable supply.

Turn ON procedure:

1. Apply drain voltage V_{dd} and set to +7 V
2. Apply enable voltage V_{en} and set to +3 V

Turn OFF procedure:

1. Turn off enable voltage V_{en}
2. Turn off drain voltage V_{dd}

RF power can be applied at any time.

GaAs MMIC devices are susceptible to damage from Electrostatic Discharge. Proper precautions should be observed during handling, assembly and test.

ver 1.2 0516

Applications Information

Evaluation Board

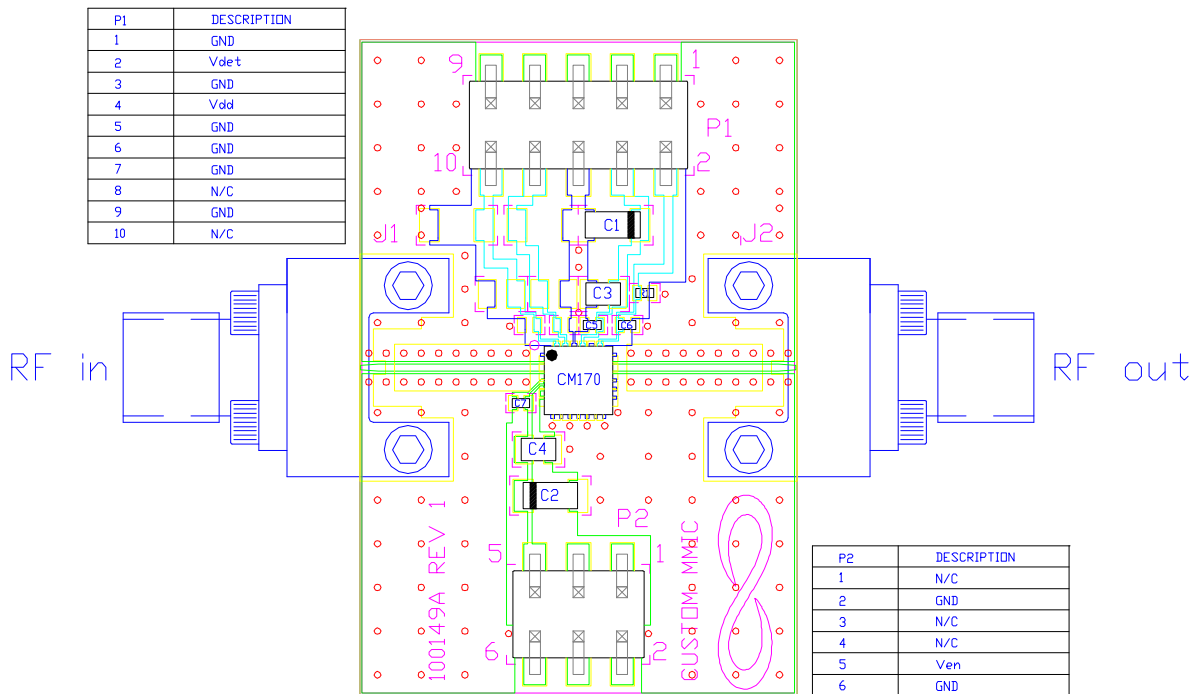

Bill of Material

Designator	Value	Description
J1, J2		SMA End Launch Connector
P1		10 Pin DC Header
P2		6 Pin DC Header
C1, C2	0.33 μ F	Capacitor, Tantalum
C3, C4	1000 pF	Capacitor, 0603
C5 - C7	100 pF	Capacitor, 0402
R1	29.4 k Ω	Resistor, 0402
U1		CMD170P4 Driver Amplifier
PCB		100149A Evaluation PCB

ver 1.2 0516