

Features

- ▶ Ultra low noise performance
- ▶ Low current consumption
- ▶ Small die size

Description

The CMD160 is a highly efficient GaAs MMIC low noise amplifier ideally suited for EW and communications systems where small size and low power consumption are needed. The device is optimized for 21 GHz and delivers greater than 26 dB of gain with a corresponding output 1 dB compression point of +8 dBm and noise figure of 1.4 dB. The CMD160 is a 50 ohm matched design which eliminates the need for external DC blocks and RF port matching. The CMD160 offers full passivation for increased reliability and moisture protection. This amplifier is the perfect alternative to higher cost hybrid amplifiers.

Functional Block Diagram

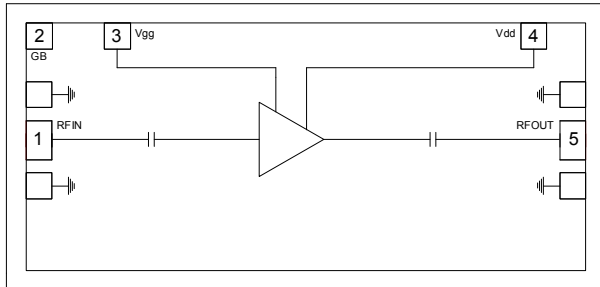

Electrical Performance - $V_{dd} = 3.0\text{ V}$, $V_{gg} = 1.5\text{ V}$, $T_A = 25\text{ }^\circ\text{C}$, $F=21\text{ GHz}$

Parameter	Min	Typ	Max	Units
Frequency Range	17 - 25			GHz
Gain		26.5		dB
Noise Figure		1.4		dB
Input Return Loss		16		dB
Output Return Loss		11		dB
Output P1dB		8		dBm
Supply Current		26		mA

Specifications

Absolute Maximum Ratings

Parameter	Rating
Drain Voltage, V _{dd}	4.0 V
Gate Voltage, V _{gg}	3.0 V
RF Input Power	+20 dBm
Channel Temperature, T _{ch}	150 °C
Power Dissipation, P _{diss}	473 mW
Thermal Resistance	137 °C/W
Operating Temperature	-55 to 85 °C
Storage Temperature	-55 to 150 °C

Operation of this device outside the maximum ratings may cause permanent damage.

Recommended Operating Conditions

Parameter	Min	Typ	Max	Units
V _{dd}	2.0	3.0	4.0	V
I _{dd}		26		mA
V _{gg}	0	1.5	3.0	V

Electrical performance is measured at specific test conditions. Electrical specifications are not guaranteed over all recommended operating conditions.

Electrical Specifications, V_{dd} = 3.0 V, V_{gg} = 1.5 V, T_A = 25 °C

Parameter	Min	Typ	Max	Min	Typ	Max	Units
Frequency Range	17 - 20		20 - 25				GHz
Gain	24	26.5	29	22	25.5	29	dB
Noise Figure		1.6	2.2		1.4	2.0	dB
Input Return Loss		9			15		dB
Output Return Loss		10			9		dB
Output P1dB		5.5			9		dBm
Output IP3		13			16		dBm
Supply Current	18	26	34	18	26	34	mA
Gain Temperature Coefficient		0.02			0.02		dB/°C
Noise Figure Temperature Coefficient		0.008			0.008		dB/°C

ver 3.5 0516

Typical Performance

Broadband Performance, $V_{dd} = 3.0\text{ V}$, $V_{gg} = 1.5\text{ V}$, $I_{dd} = 26\text{ mA}$, $T_A = 25\text{ }^\circ\text{C}$

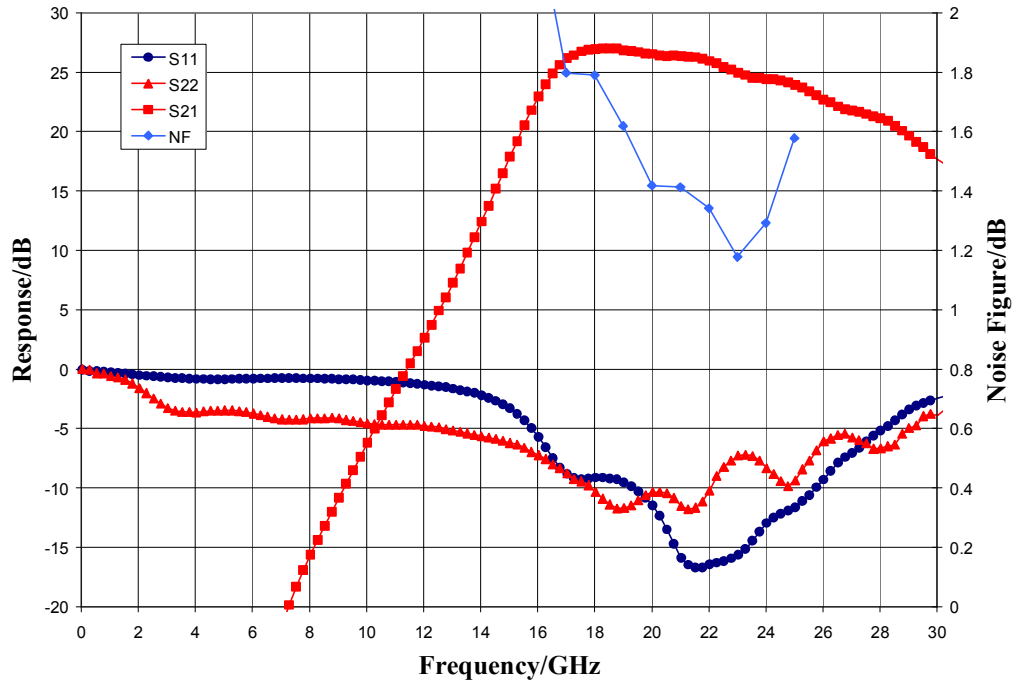

Narrow-band Performance, $V_{dd} = 3.0\text{ V}$, $V_{gg} = 1.5\text{ V}$, $I_{dd} = 26\text{ mA}$, $T_A = 25\text{ }^\circ\text{C}$

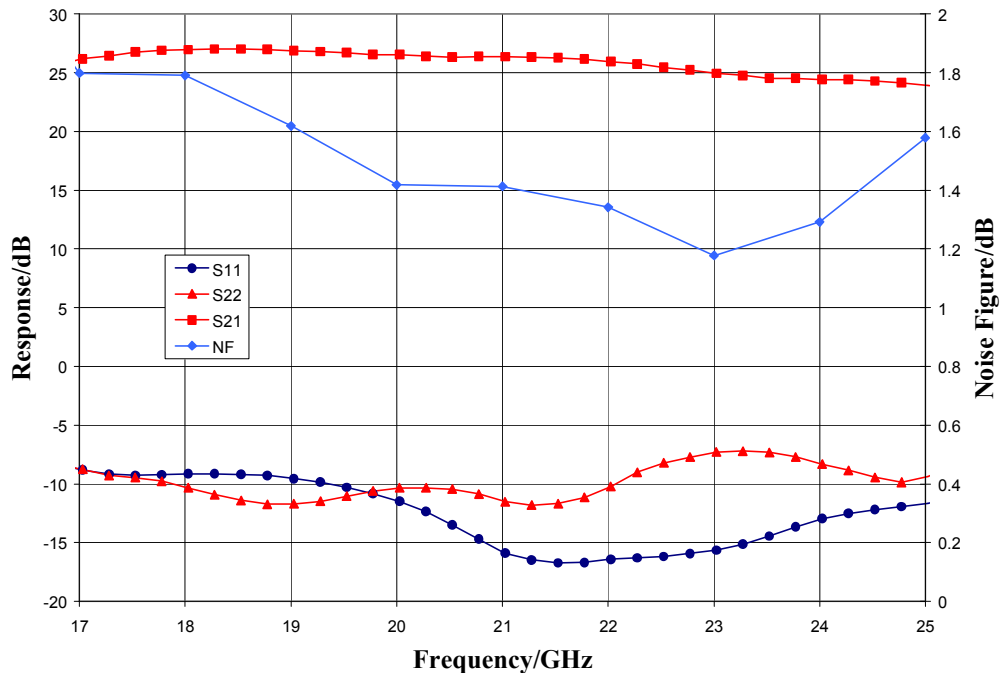

ver 3.5 0516

Typical Performance

Gain vs. Temperature, $V_{dd} = 3.0\text{ V}$, $V_{gg} = 1.5\text{ V}$

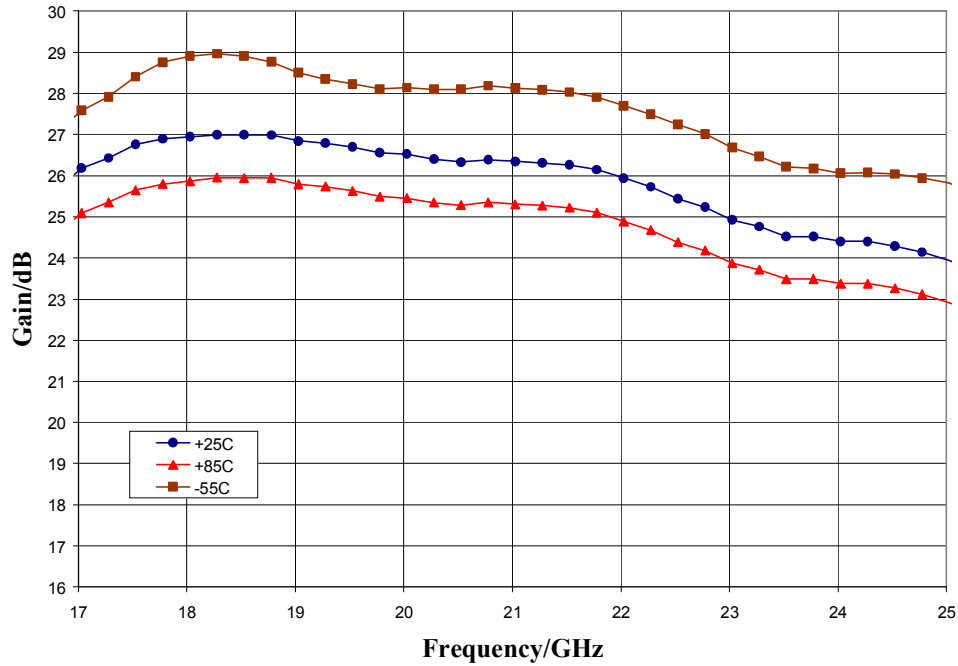

Noise Figure vs. Temperature, $V_{dd} = 3.0\text{ V}$, $V_{gg} = 1.5\text{ V}$

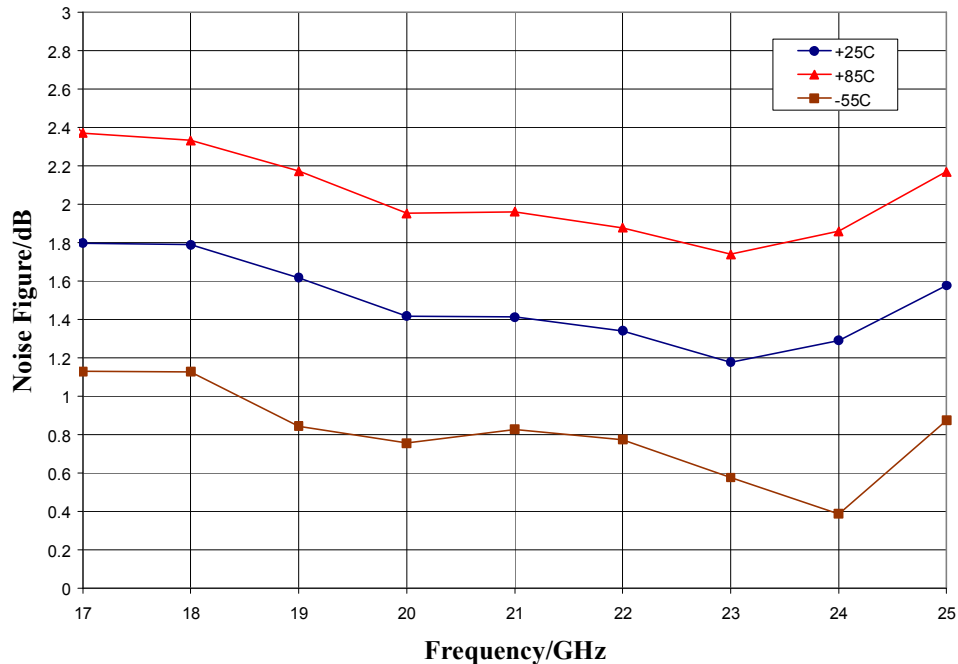

ver 3.5 0516

Typical Performance

Output Power, $V_{dd} = 3.0\text{ V}$, $V_{gg} = 1.5\text{ V}$, $I_{dd} = 26\text{ mA}$, $T_A = 25\text{ }^\circ\text{C}$

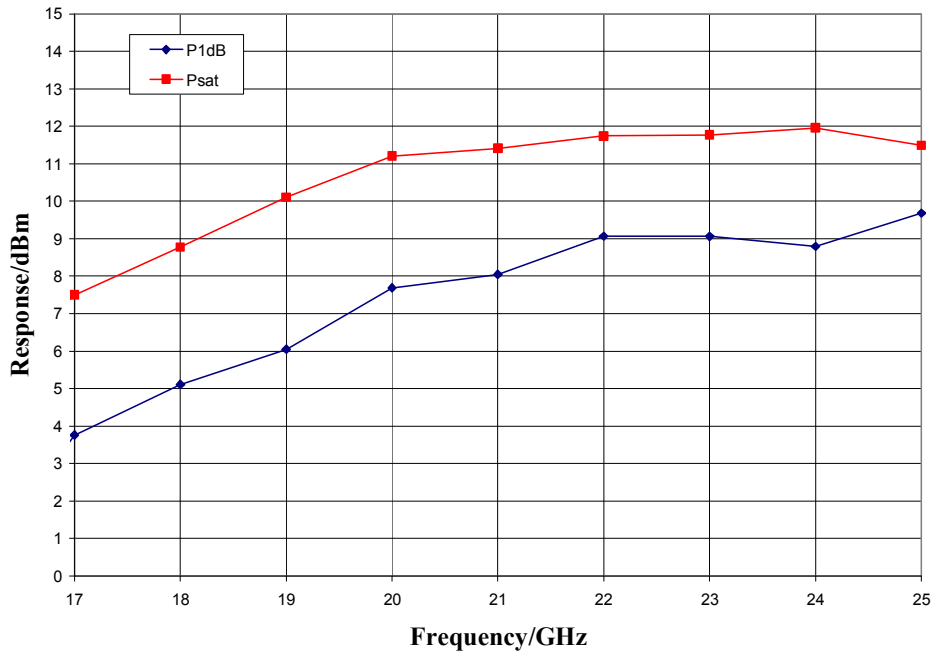

Output IP3, $V_{dd} = 3.0\text{ V}$, $V_{gg} = 1.5\text{ V}$, $I_{dd} = 26\text{ mA}$, $T_A = 25\text{ }^\circ\text{C}$

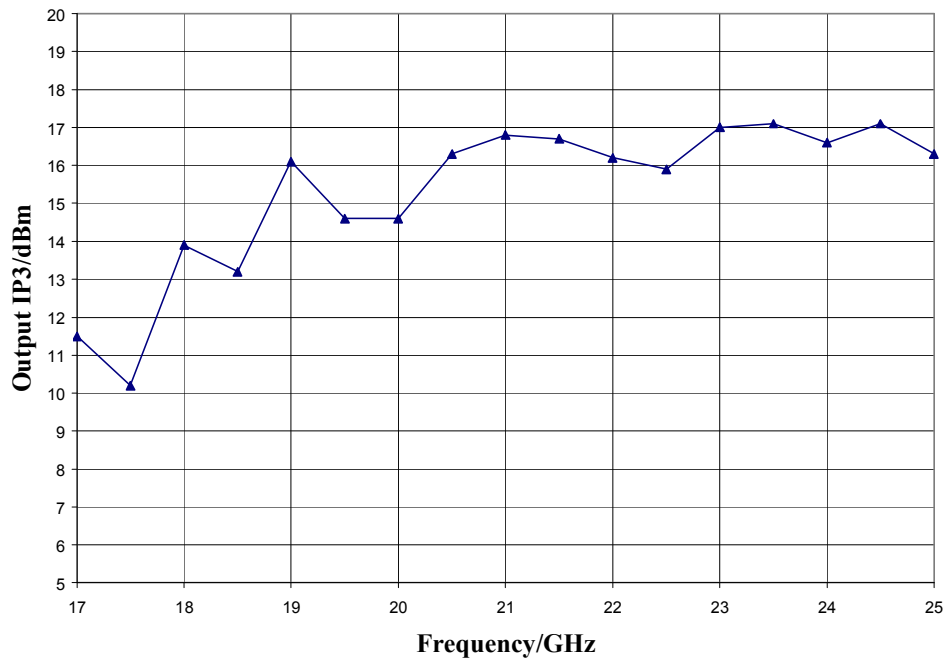

ver 3.5 0516

Mechanical Information

Die Outline (all dimensions in microns)

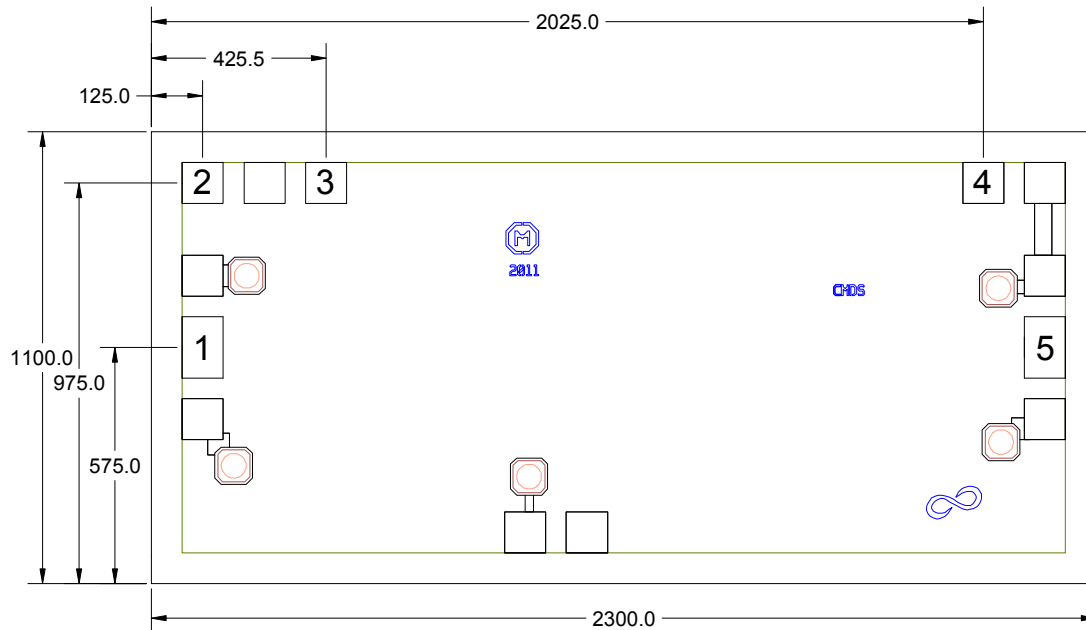

Notes:



1. No connection required for unlabeled pads
2. Backside is RF and DC ground
3. Backside and bond pad metal: Gold
4. Die is 85 microns thick
5. DC bond pads are 100 microns square

Pad Description

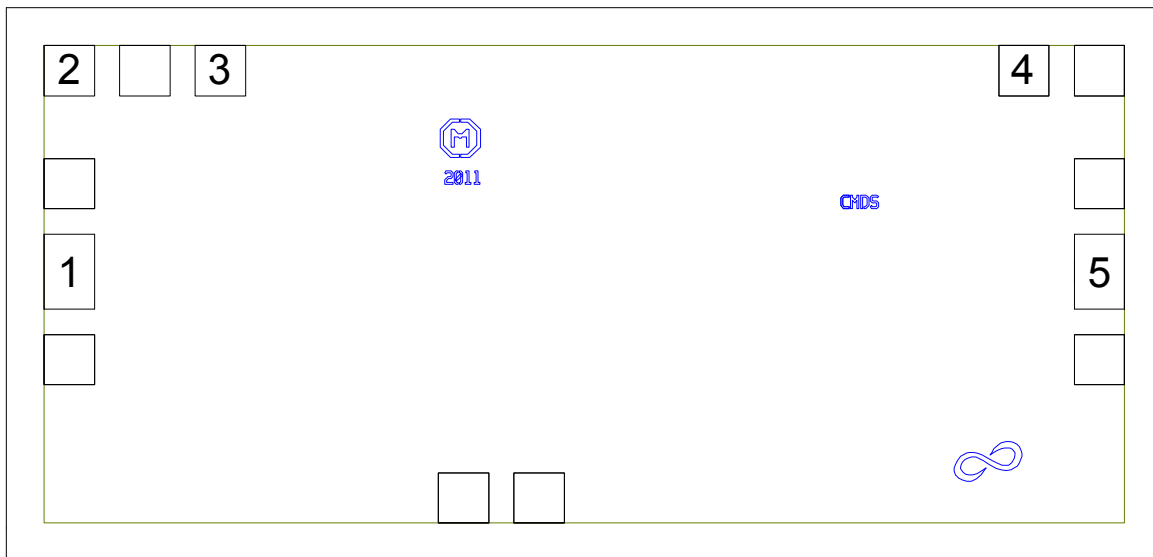
Pad Diagram

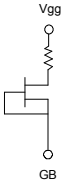
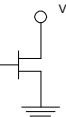
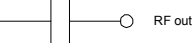

Functional Description

Pad	Function	Description	Schematic
1	RF in	DC blocked and 50 ohm matched	
2	GB	Connect to DC ground	
3	Vgg	Power supply voltage Decoupling and bypass caps required	
4	Vdd	Power supply voltage Decoupling and bypass caps required	
5	RF out	DC blocked and 50 ohm matched	
Backside	Ground	Connect to RF / DC ground	

ver 3.5 0516

Applications Information

Assembly Guidelines

The backside of the CMD160 is RF ground. Die attach should be accomplished with electrically and thermally conductive epoxy only. Eutectic attach is not recommended. Standard assembly procedures should be followed for high frequency devices. The top surface of the semiconductor should be made planar to the adjacent RF transmission lines, and the RF decoupling capacitors placed in close proximity to the DC connections on chip.

RF connections should be made as short as possible to reduce the inductive effect of the bond wire. Use of a 0.8 mil thermosonic wedge bonding is highly recommended as the loop height will be minimized. The RF input and output require a double bond wire as shown.

The semiconductor is 85 μm thick and should be handled by the sides of the die or with a custom collet. Do not make contact directly with the die surface as this will damage the monolithic circuitry. Handle with care.

Assembly Diagram

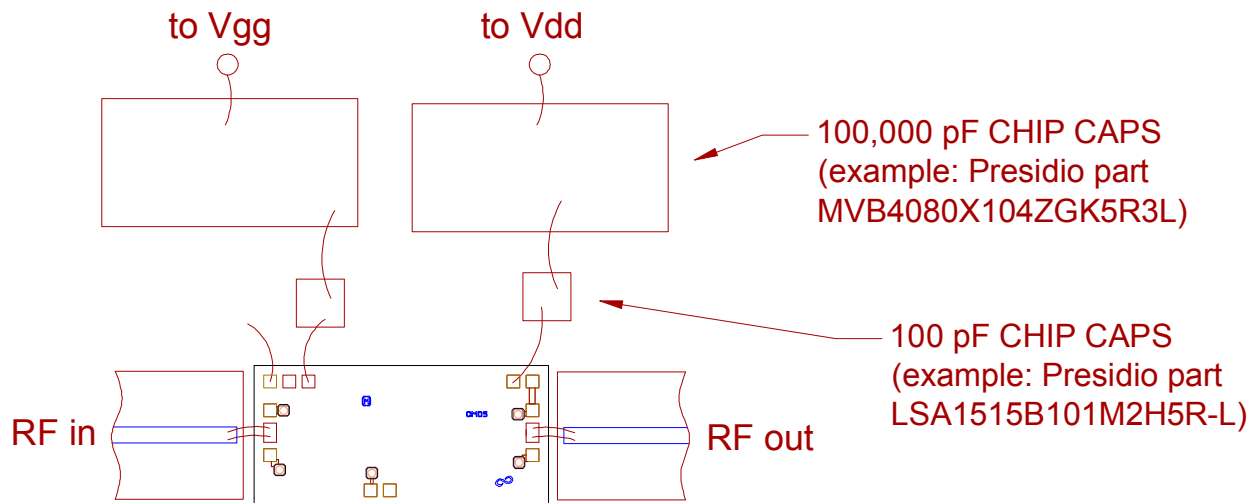

GaAs MMIC devices are susceptible to damage from Electrostatic Discharge. Proper precautions should be observed during handling, assembly and test.

ver 3.5 0516

Applications Information

Biasing and Operation

The CMD160 is biased with a positive drain supply and positive gate supply. Performance is optimized when the drain voltage is set to +3.0 V, though it may be set to a minimum of +2.0 V and a maximum of +4.0 V. The recommended gate voltage is +1.5 V.

Turn ON procedure:

1. Apply drain voltage V_{dd} and set to +3 V
2. Apply gate voltage V_{gg} and set to +1.5 V

Turn OFF procedure:

1. Turn off gate voltage V_{gg}
2. Turn off drain voltage V_{dd}

RF power can be applied at any time.